

Danfoss

Ever increasing innovation

RA2000 Range
Commercial TRVs





Contact Details

Telephone & Fax Numbers

Reception T 0845 - 1217 400

F 0845 - 1217 515

UK Sales T 0845 - 1217 500

F 0845 - 1217 510

Rep. of Ireland Sales

T 353- 1- 6268111

F 353 - 1- 6269334

Training T 0845 - 1217 501

F 0845 - 1217 513

Literature T 0845 - 1217 501

F 0845 - 1217 513

Customer Service

T 0845 - 1217 502

Technical Support

T 0845 - 1217 505

F 0845 - 1217 510

For your convenience you can contact us on local rate 0845 numbers. All office based staff also have their own individual local rate direct dial number.



Danfoss Randall Ltd.
Amphill Road
Bedford
MK42 9ER
T 0845 - 1217 400
F 0845 - 1217 515

www.danfoss-randall.co.uk

Frequently Asked Questions section

What to do when your battery symbol is flashing?

What is a direct replacement control for a SET5?

What does chrono-proportional actually mean?

Heating Controls are easy! Download a series of pdfs explaining all you ever need to know about central heating systems and how they work.

All this information and more available on the website.

Online literature available

Datasheets, installation and user instructions available in PDF format

Additional links to corporate homepage and Danfoss Worldwide across top

Site Search and Product Search facilities

Up to date Press Releases

Contact email addresses for Sales, Technical Support, Training & Literature enquiries

Convenient Stockist Search

Photography Acknowledgements
Information Sign: Joe Gough, Direction Sign: Guy Erwood,
Telephone: Robin George, Thermometer: Alexey Klementiev



Contents

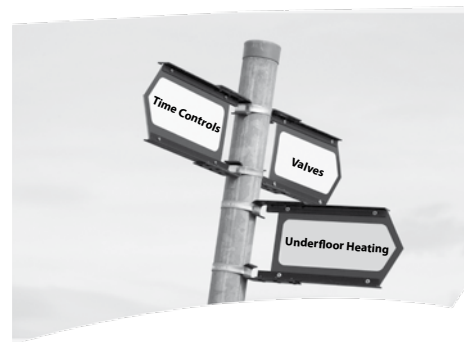

Valve Bodies	6-9	Valve Capacities	20-22
RA-FN Valves for 2-Pipe Systems	6	RA-N10 and RA-FN10	20
RA-N Valves for 2-Pipe Systems (with pre-setting)	7	RA-N15 and RA-FN15	21
RA-N & RA-FN Dimensions	8	RA-N20/25 and RA-FN20/25	21
RA-G Valves for 1-Pipe Systems	9	RA-N20 and RA-FN20	22
		RA-G	22
Sensors	10-13	Selection Guide	23
RA2910 and RA2914 Built-in Sensors	10	Notes	24
RA2912 and RA2916 Remote Sensors	11	Literature Service	27
RA2920 & RA2922 Tamperproof Sensors	12		
RA5062, RA5065 and RA5068 Remote Adjusters	13		
Lockshield Valves	14-15		
RLV with Drain Off	14		
RLV-S without Drain Off	15		
H-Pieces	16-17		
RLV-KD with Drain Off	16		
RLV-KS without Drain Off	17		
Fittings	18		
Copper	18		
PEX	18		
ALUPEX	18		
Spare Parts & Accessories	19		
Gland Seals	19		
Tool Kit	19		
Valve Adaptor	19		
Manual Positive Shut-Off Knob	19		
Replacement Sensors	19		



RA2910



RA-FN Straight



RA-N





General Information

Danfoss are world leaders in the design and manufacture of radiator thermostats. Having invented the concept in 1943 Danfoss have, in the ensuing years, gone on to develop and manufacture numerous generations of radiator thermostat, offering ever improved performance.

The knowledge and experience of radiator thermostats possessed by Danfoss is unsurpassed, bringing together more than half a century of design, manufacturing and application knowledge that is second to none.

The rapid growth in the sale of radiator thermostats has, to a large extent, been down to the simplicity of the products, in terms of application and ease of use. Generally the more sophisticated the design, the more energy efficient and reliable the product

is and Danfoss are at the top of the list when it comes to energy efficiency and reliability.

The need for high performance is never greater than in the demanding commercial heating market. In addition to expectations of high performance, specifiers and building owners also expect products which can withstand inevitable heavy handling and, in some cases, misuse plus be long lasting into the bargain.

The Danfoss RA2000 range is based on a saturated vapour sensor to provide the ultimate in control performance. The reason for this much improved performance is the well defined sensor location, and the small mass of the gas charge (saturated vapour) compared to other types (eg. liquid or wax).



RA 2910

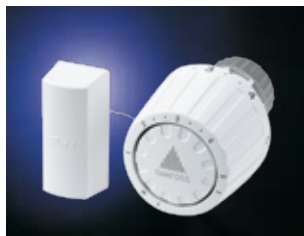

RA 2912 Horizontal



RA 2950

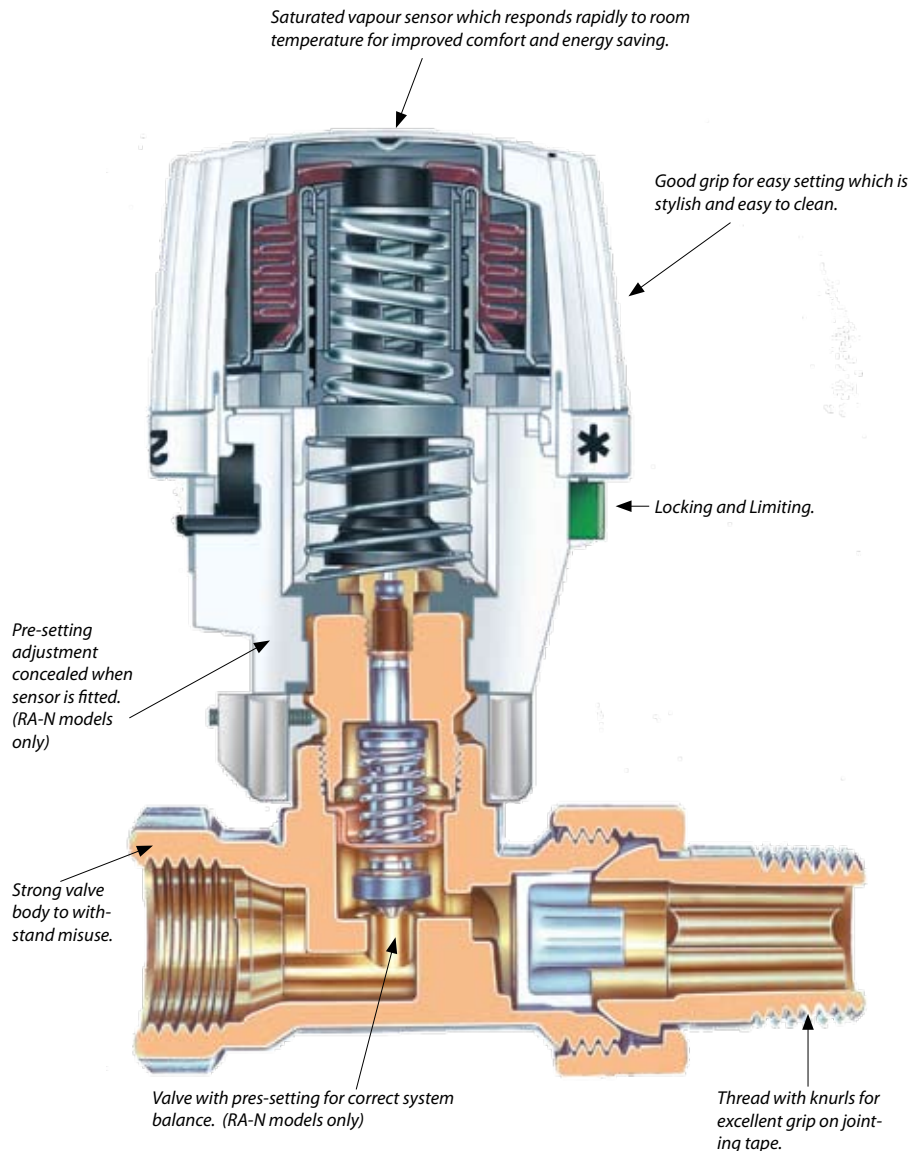

Additional Information:
www.danfoss-randall.co.uk

Which radiator thermostat and valve



Commercial TRV's and Lockshield Valves - Valve Bodies				
1-Pipe Systems	2-Pipe Systems			Page
Without Pre-Setting	Without Pre-Setting	With Pre-Setting	Lockshield Valves	
RA-G				9
	RA-FN			6
		RA-N		7
			RLV*	14
			RLV-S	15

* RLV has drain-off facility

Commercial TRV's - Sensors							
Built-In			Remote			Remote Adjusters 2m, 5m, & 8m capillary lengths	Page
Standard	Low Temp	Tamper-proof	Standard	Low Temp	Tamper-proof		
RA 2910	RA 2914						10
		RA 2920					12
			RA 2912	RA2916			11
					RA 2922		12
						RA 5062-2m	13
						RA 5065-5m	13
						RA 5068-8m	13

Commercial TRV's - H-Pieces, Spares, Accessories & Compression Fittings				
H-Pieces	Spares	Accessories	Pipe Fittings	Page
RLVD-KD				16
RLV-KS				17
			Copper	18
			PEX	18
			ALUPEX	18
	Glandseal	Tool Kit		19
		Adaptor		19
		Wheel Head		19



RA-FN



RA-G



RA-N

Additional Information:
www.danfoss-randall.co.uk





Summary

- RA-FN valves without pre-setting
- RA-FN valves are easily recognised by a grey cover cap
- Available in vertical angle, horizontal angle and straight pattern versions in 3/8", 1/2", 3/4" & 1" sizes
- May also be used with RAS-D² and RAS-C² sensors



RA-FN Straight



RA-FN Vertical



RA-FN Horizontal Angle

RA-FN Valves for 2-Pipe Systems

RA-FN valves are designed for use in 2-pipe heating systems where circulation through both pipe work and radiator is pumped. They are conventional uni-directional valves without pre-setting; system balancing must be made using lockshield valves installed on the radiator return connection. Please refer to pages 14 & 15 for matching lockshield valves.

A wide range of compression fittings for copper, PEX and ALUPEX pipe are available for use with RA-FN valves, please refer to [page 18](#).

All valves incorporate a gland-seal assembly that can be replaced without the need for special tools and without draining down the system.

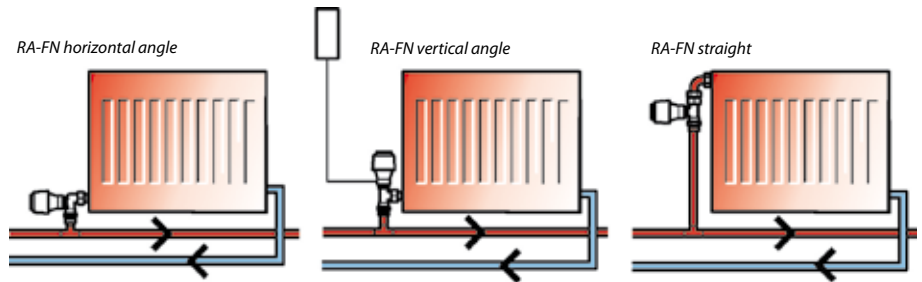

RA-FN Valve Bodies for 2-Pipe Systems					
Pattern	Type	Code No	Connections		Kv Value Xp = 2K ⁽²⁾
			Pipe	Radiator Tail	
Straight	RA-FN 10	013G002200	3/8" BSP	3/8" BSP	0.56
	RA-FN 15	013G002400	1/2" BSP	1/2" BSP	0.73
	RA-FN 15	013G008400	15mm or 1/2" BSP	1/2" BSP	0.73
	RA-FN 20	013G002600	3/4" BSP	3/4" BSP	1.04
	RA-FN 25	013G002800	1" BSP	1" BSP	1.04
Vertical Angle ⁽¹⁾	RA-FN 10	013G002100	3/8" BSP	3/8" BSP	0.56
	RA-FN 15	013G002300	1/2" BSP	1/2" BSP	0.73
	RA-FN 15	013G0023AA	15mm or 1/2" BSP	1/2" BSP	0.73
	RA-FN 20	013G002500	3/4" BSP	3/4" BSP	1.04
	RA-FN 25	013G002700	1" BSP	1" BSP	1.04
Horizontal Angle	RA-FN 10	013G014100	3/8" BSP	3/8" BSP	0.56
	RA-FN 15 UK	013G014900	15mm or 1/2" BSP	1/2" BSP	0.73
	RA-FN 20	013G014500	3/4" BSP	3/4" BSP	0.80

(1) To ensure optimum performance use remote sensor
 (2) Kv values when used with RA2000 sensors

Technical Specifications	
Maximum Operating Temperature	120°C
Maximum Working Pressure	10 Bar
Maximum Differential Pressure	0.6 Bar

See page 8 for dimensions



Additional Information:
Sizing charts see p. 20-22

RA-N Valves for 2-Pipe Systems

RA-N valves are designed for use in 2-pipe heating systems where circulation through both pipe work and radiator is pumped. They are uni-directional valves with integrated pre-setting. Pre-setting allows the commissioning engineer to precisely set the flow rate through the valve by adjusting the valve capacity to match the radiator heat output requirement.

Pre-setting is carried out by setting a calibrated orifice within the valve. The setting is achieved by turning a scale located in the top part of the valve body. The setting mechanism is concealed once the thermostat sensor is fitted. This type of

pre-setting is significantly more accurate than that possible with conventional lockshield valve. When pre-setting valves are used the role of the lockshield valve is simply to provide isolation for radiator removal.

RA-FN valves are suitable for use with all RA2000 sensors and may also be used with RAS-D2 and RAS-C² sensors. Please refer to our technical department for capacity information if using RAS-D² or RAS-C² sensors.

All valves incorporate a gland-seal assembly that can be replaced without the need for special tools and without draining down the system.

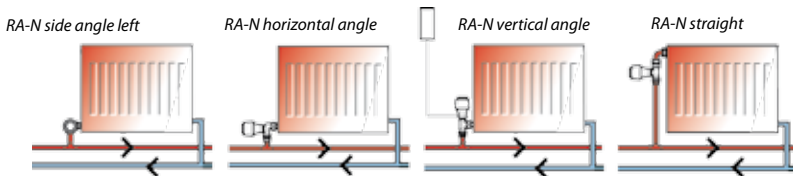

RA-N Valve Bodies for 2-Pipe Systems, with Pre-Setting						
Pattern	Type	Code No	Connections		Kv Value ⁽¹⁾⁽³⁾ Xp = 2K	
			Pipe	Radiator Tail	Min	Max
Straight	RA-N 10	013G003200	3/8" BSP	3/8" BSP	0.04	0.56
	RA-N 15	013G003400	1/2" BSP	1/2" BSP	0.04	0.73
	RA-N 15	013G0034AA	15mm or 1/2" BSP	1/2" BSP	0.04	0.73
	RA-N 20	013G003600	3/4" BSP	3/4" BSP	0.10	1.04
	RA-N 25	013G003800	1" BSP	1" BSP	0.10	1.04
Vertical ⁽²⁾ Angle	RA-N 10	013G003100	3/8" BSP	3/8" BSP	0.04	0.56
	RA-N 15	013G003300	1/2" BSP	1/2" BSP	0.04	0.73
	RA-N 15	013G0033AA	15mm or 1/2" BSP	1/2" BSP	0.04	0.73
	RA-N 20	013G003500	3/4" BSP	3/4" BSP	0.10	1.04
	RA-N 25	013G003700	1" BSP	1" BSP	0.10	1.04
Horizontal Angle	RA-N 10	013G015100	3/8" BSP	3/8" BSP	0.04	0.56
	RA-N 15	013G015300	1/2" BSP	1/2" BSP	0.04	0.73
	RA-N 15	013G0153AA	15mm or 1/2" BSP	1/2" BSP	0.04	0.73
	RA-N 20	013G015500	3/4" BSP	3/4" BSP	0.16	0.80
Side Angle ⁽⁴⁾	RA-N 10L	013G023100	3/8" BSP	3/8" BSP	0.04	0.56
	RA-N 10R	013G023200	3/8" BSP	3/8" BSP	0.04	0.56
	RA-N 15L ⁽⁵⁾	013G23300	1/2" BSP	1/2" BSP	0.04	0.73
	RA-N 15R ⁽⁵⁾	013G023400	1/2" BSP	1/2" BSP	0.04	0.73

(1) Kv value at Xp = 2 when used with RA2000 sensors
 (2) To ensure optimum performance use remote sensor
 (3) Refer to setting table supplied with valves to adjust Kv
 (4) L = Left, R = Right
 (5) Also available in Chrome finish. Details available at request.

Technical Specifications	
Maximum Operating Temperature	120°C
Maximum Working Pressure	10 Bar
Maximum Differential Pressure	0.6 Bar



Summary

- RA-N valves with pre-setting for larger heating systems
- RA-N valves in flow
- RA-N valves are easily recognised by a red cover cap
- Available in vertical angle, horizontal angle, side angle and straight pattern versions in 3/8", 1/2", & 1" sizes
- Wide range of fittings available see page 18



RA-N



RA-N

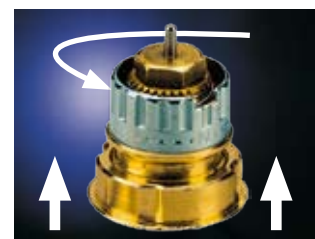

Calibrated Setting Scale RA-N

Additional Information:

Compression Fittings p. 18, Matching Lockshield valves p.14-15, Sizing charts p. 20-22

Danfoss



RA-N & RA-FN Dimensions

Pattern	Type	D d ₂ BSP		L ₁	L ₂	L ₃	L ₄	L ₅	L ₆	L ₇ *	L ₈	L ₉	L ₁₀	Arc. Flats	
		S ₁	S ₂												
Straight	RA-FN 10	3/8"	3/8"	60	85				47	96				22	27
	RA-FN 15	1/2"	1/2"	67	95				47	96				27	30
	RA-FN 20	3/4"	3/4"	74	106				52	101				32	37
	RA-FN 25	1"	1"	90	126				52	101				41	46
Vertical Angle	RA-FN 10	3/8"	3/8"			27	52	22	47	96				22	27
	RA-FN 15	1/2"	1/2"			30	58	26	47	96				27	30
	RA-FN 20	3/4"	3/4"			34	66	29	52	101				32	37
	RA-FN 25	1"	1"			40	75	34	52	101				41	46
Horiz. Angle	RA-FN 10	3/8"	3/8"						59	108	26	51	22	22	27
	RA-FN 15 UK	1/2"	1/2"						60	109	26	55	44	27	30
	RA-FN 20	3/4"	3/4"						61	110	34	66	30	32	27

* Add 32mm to L₇ to allow for sensor removal.

Pattern	Type	D d ₂ BSP		L ₁	L ₂	L ₃	L ₄	L ₅	L ₆	L ₇ *	L ₈	L ₉	L ₁₀	Arc. Flats	
		S ₁	S ₂												
Straight	RA-N 10	3/8"	3/8"	60	85				47	96				22	27
	RA-N 15	1/2"	1/2"	67	95				47	96				27	30
	RA-N 20	3/4"	3/4"	74	106				52	101				32	37
	RA-N 25	1"	1"	90	126				52	101				41	46
Vertical Angle	RA-N 10	3/8"	3/8"			27	52	22	47	96				22	27
	RA-N 15	1/2"	1/2"			30	58	26	47	96				27	30
	RA-N 20	3/4"	3/4"			34	66	29	52	101				32	37
	RA-N 25	1"	1"			40	75	34	52	101				41	46
Horiz. Angle	RA-N 10	3/8"	3/8"						59	108	26	51	22	22	27
	RA-N 15	1/2"	1/2"						60	109	26	55	44	27	30
	RA-N 20	3/4"	3/4"						61	110	34	66	30	32	27
Side Angle	RA-N 10	3/8"	3/8"						47	103	27	52	27	22	27
	RA-N 15	1/2"	1/2"						47	96	30	58	33	27	30

* Add 32mm to L₇ to allow for sensor removal.

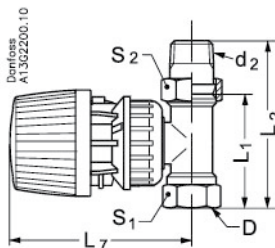

Straight - RA-N or RA-FN

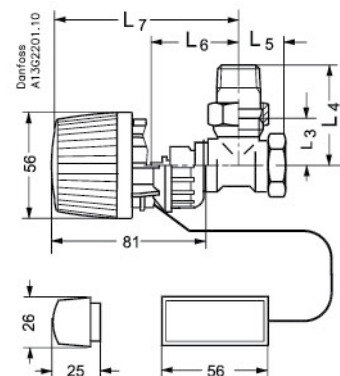

Vertical Angle - RA-N or RA-FN

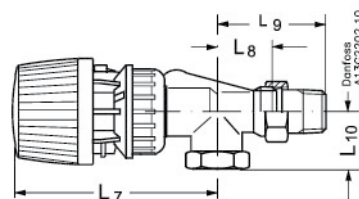

Horizontal Angle - RA-n 10, 15 or 20 & RA-FN 10 or 20



Additional Information:
www.danfoss-randall.co.uk

RA-G Valves

For 1-Pipe Systems

RA-G valves are high capacity low resistance valves for use in conventional 1-pipe heating systems in which water circulation through the radiator is mainly by thermo-siphon. In such systems the circulating pressure available to overcome the frictional resistance of the valve and the radiator is extremely low and is generally insufficient to overcome the resistance of normal 2-pipe radiator thermostats.

RA-G valves are specifically designed for use in such systems and have large diameter valve cones which deliver high capacities at low proportional offsets ensuring that comfort temperatures can be maintained under all load conditions. All valves incorporate a gland-seal assembly that can be replaced without the need for special tools and without draining down the system.



Summary

- RA-G valves in flow
- RA-G valves have a grey cover cap and are easily recognised by the larger valve body style
- Suitable for use with all RA2000 sensors
- Available in both vertical angle and straight pattern designs in 1/2", 3/4" and 1" sizes

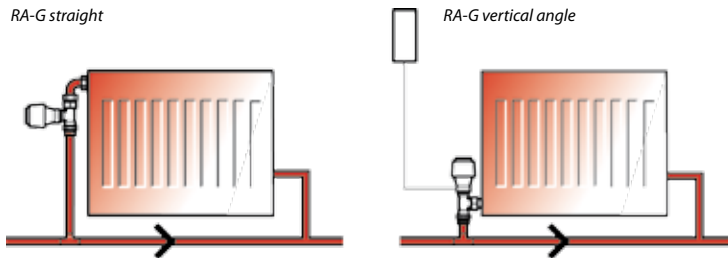

RA-G Valve Bodies for 1-Pipe Systems					
Pattern	Type	Code No	Connections		Kv Value $X_p = 2K^{(2)}$
			Pipe ⁽³⁾	Radiator Tail	
Straight	RA-G 15	013G338400	1/2" BSP	1/2" BSP	1.42
	RA-G 20	013G338600	3/4" BSP	3/4" BSP	2.06
	RA-G 25	013G338800	1" BSP	1" BSP	2.69
Vertical Angle ⁽¹⁾	RA-G 15	013G338300	1/2" BSP	1/2" BSP	1.42
	RA-G 20	013G338500	3/4" BSP	3/4" BSP	2.06
	RA-G 25	013G338700	1" BSP	1" BSP	2.69

Please note:
 (1) To ensure optimum performance use remote sensor
 (2) Kv values when used with RA2000 Sensors
 (3) Not suitable for use with Fittings listed on page 18

Technical Specifications	
Maximum Operating Temperature	120°C
Maximum Working Pressure	10 Bar
Maximum Differential Pressure (RA-G 25)	0.16 Bar
Maximum Differential Pressure (RA-G 15 & 20)	0.2 Bar

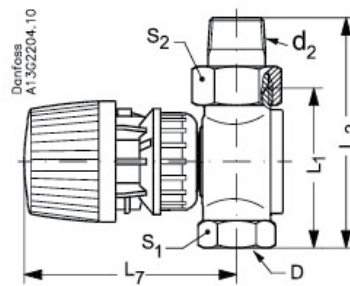
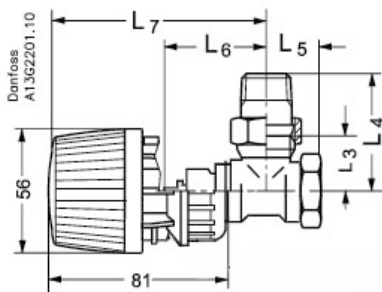

RA-G straight



RA-G vertical angle

Type	DN	D	d ₂	L ₁	L ₂	L ₃	L ₄	L ₅	L ₆	L ₇ *	S ₁	S ₂
RA-G 15	15	1/2"	1/2"	68	96	30	58	26	56	105	27	30
RA-G 20	20	3/4"	3/4"	75	107	34	66	29	59	108	32	37

Additional Information:
Sizing charts see p. 20-22





Summary

- RA2910 temperature range 5-26°C
- RA2914 low temperature range 5-22°C
- All models have locking and limiting feature
- Use with RA-N, RA-FN or RA-G valves

RA2000 Built-in Sensors

RA2000 sensors are high performance temperature sensors ideally suited for commercial applications. The temperature sensor uses a frictionless bellows charged with a small volume of liquefied gas. The sensor relies upon the state change from liquid to a gas as the temperature of the liquid increases to modulate the valve towards the closed position. When the temperature falls the gas condenses back to a liquid and the spring within the sensor allows the valve to modulate open until the bellows pressure and spring pressure are equal, and the valve cone is stationary.

This type of saturated vapour pressure sensor has many advantages including low thermal mass giving very quick reaction times and a defined sensor location at coolest part of bellows system. This latter feature gives the product a very low flow temperature dependence making it ideal for use in systems with weather compensated flow temperatures.

The range includes standard temperature range (5-26°C) and low temperature range (5-22°C) models. Both incorporate range locking and limiting features that allow the commissioning engineer to lock or limit the setting range of the sensor.

For best performance built-in temperature sensors should be mounted horizontally. As with any thermostat, care should be taken not to cover the thermostat or to locate where it may be influenced by heat from electrical appliance or cold draughts.

RA2000 Built-in Sensors			
Type	Code No	Sensor (max sensor temp 60°C)	Temp Range Xp = 2K
RA2910	013G291000	Built-in	5-26°C
RA2914	013G291400	Built-in, low temperature range model	5-22°C

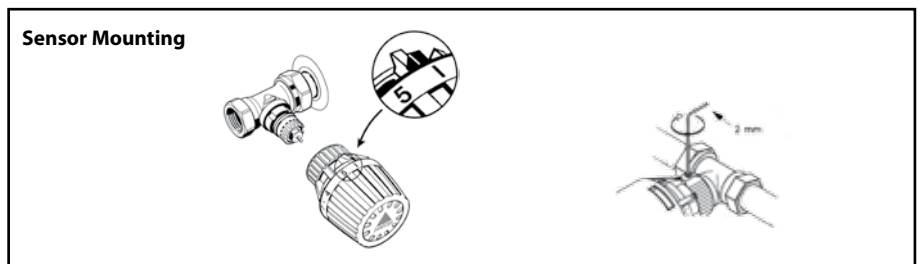
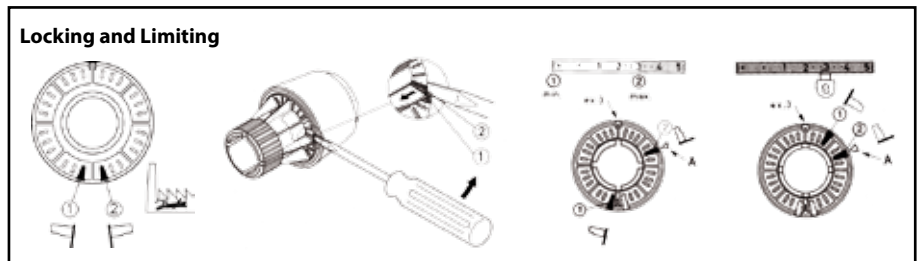

RA2910 Built in Sensor

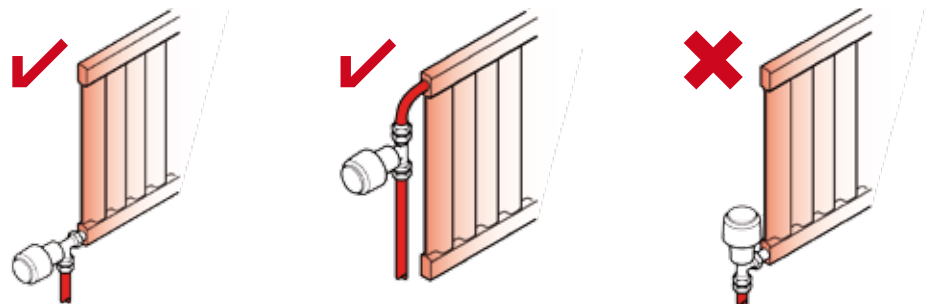

Additional Information:
See page 12 for Tamper Proof version

RA2000 Remote Sensors

Utilising the same sensor technology as the built-in sensor, remote sensors are ideal for use in situations where built-in sensors may be adversely affected by heat gains or cold draughts. Remote sensors are also ideal for use with cased in radiators or in situations where the emitter is located for example in a floor trench or heated ceiling.

Remote sensors comprise a setting unit that is mounted on the valve and a remote sensor which can be located up to 2 metres from the setting unit. The two components are interconnected by an ultra-thin capillary tube that is wound up in the remote sensor case. During installation, the required length of tube is pulled out and fixed to the wall with clips or by staple gun.

The range includes standard temperature range (5-26°C) and low temperature range (5-22°C) models. Both incorporate range locking and limiting features that allow the commissioning engineer to lock or limit the setting range of the sensor.

Mounting

Sensor mounting and locking and limiting are the same as for built-in sensors. Please see page 10. The capillary tube is wound round the remote sensor.

Firstly mount the sensor as with a standard built-in sensor. Then mount the bracket on the wall, either horizontally or vertically.

Pull the remote sensor to unwind the required length of capillary tube and mount the remote sensor into the bracket. Finally finish the installation by mounting the snap-on cover.

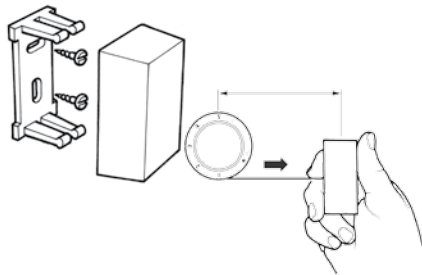

Summary

- RA2912 temperature range 5-26°C
- RA2916 low temperature range 5-22°C
- All models have locking and limiting feature
- Capillary can be adjusted between 0-2 metres
- Use with RA-N, RA-FN or RA-G valves

RA2000 Remote Sensors			
Type	Code No	Sensor (max sensor temp 60°C)	Temp Range Xp = 2K
RA2912	013G291200	Remote Sensor, 0-2m capillary tube	5-26°C
RA2916	013G291600	Remote Sensor, 0-2m capillary tube	5-22°C

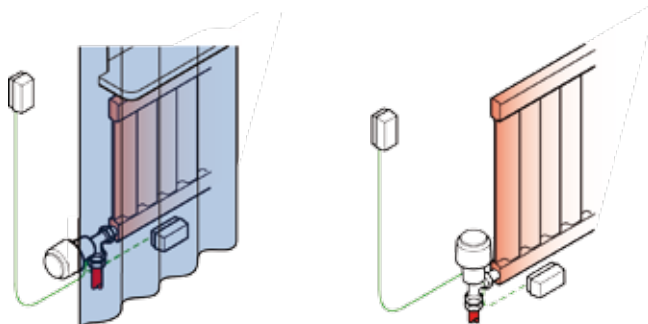

RA2912 Remote Sensor

Additional Information:
See page 12 for Tamper Proof version





Summary

- RA2920 built-in sensor
- RA2922 remote sensor, 0-2m capillary
- Temperature range 5-26°C
- Tamperproof, high strength
- Locking and limiting
- Use with RA-N, RA-FN or RA-G valves

RA2000 Tamperproof Sensors

In addition to the standard built-in and remote sensors, the range also features special tamperproof versions for use in institutional applications and in areas where vandalism may occur. These products utilise the same sensor system as other RA2000 sensors.

that allow the commissioning engineer to lock or limit the setting range of the sensor.

These special versions are substantially stronger than the standard product and incorporate enhanced locking and limiting. Tamper-proof models are available in both built-in and remote sensor versions.

The temperature range of these models is 5-26°C. Both built-in and remote sensor models incorporate range locking and limiting features

RA2000 Built-in Sensors			
Type	Code No	Sensor (max sensor temp 60°C)	Temp Range Xp = 2K
RA2920	013G292000	Built-in, tamperproof	5-26°C
RA2944	013G292200	Remote sensor, 0-2m capillary tube, tamperproof	5-26°C

Accessories	
Code No	Description
013G123200	Anti-theft plugs for Sensors (50 pieces)
013G123700	Threaded range limiting pins (30 pieces)
013G123300	Scale cover (20 pieces)
013G123600	Toolkit, comprising of; Allen Key and Locking Pin Tool

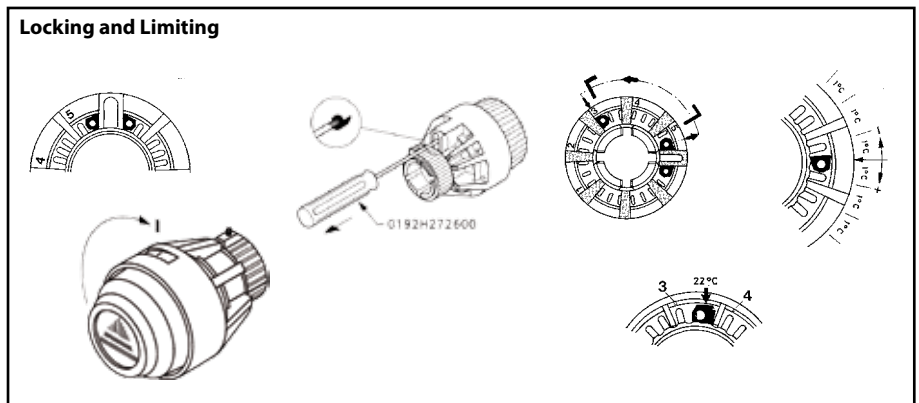
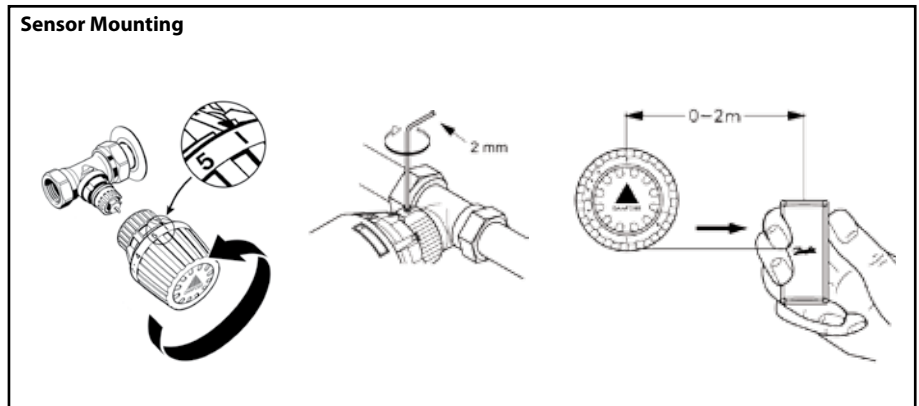

RA2920 Tamperproof Sensor



Additional Information:
www.danfoss-randall.co.uk

RA2000 Remote Adjusters

In addition to built-in and remote sensors, the RA2000 range also include versions that take both sensing and temperature adjustment away from the valve. These remote temperature adjusters are ideal for use in situations where radiators are encased or where the demand is to locate the temperature adjustment at a position more convenient than on the radiator.

This could for example be in residential accommodation for the elderly or disabled. The product is also an ideal solution for heated ceiling applications.

The remote temperature adjuster models comprise an actuator that is mounted on the valve and a thermostat unit which provides temperature sensing and adjustment. These are interconnected by an ultra-thin capillary tube that is wound up inside the remote adjuster. During installation the installer pulls out the required length of capillary and fixes it to the wall using clips or staples. The capillary can also be drawn through a suitably sized straight conduit. Please refer to ordering table for capillary length options.

Dimensions

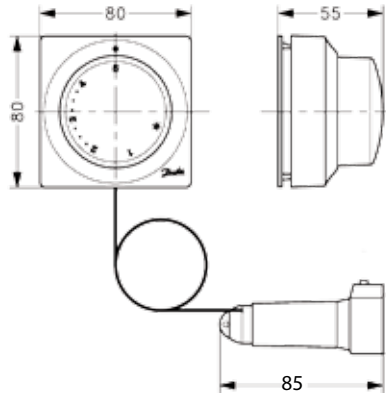

Summary

- Temperature range 8-28°C
- Available with 2, 5 or 8m capillary
- All models have locking and limiting feature
- Use with RA-N, RA-FN or RA-G valves

RA2000 Remote Sensor Adjusters			
Type	Code No	Sensor (max sensor temp 60°C)	Temp Range Xp = 2K
RA5062	013G506200	2m Capillary includes locking and limiting	8-28°C
RA5065	013G506500	5m Capillary includes locking and limiting	8-28°C
RA5068	013G506800	8m Capillary includes locking and limiting	8-28°C

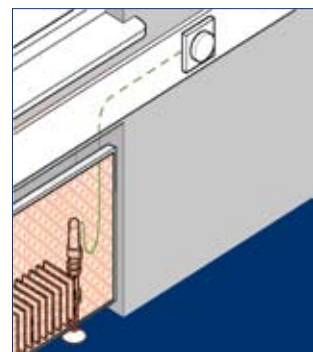
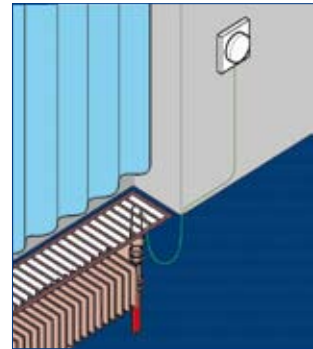

RA5062 Remote Adjuster

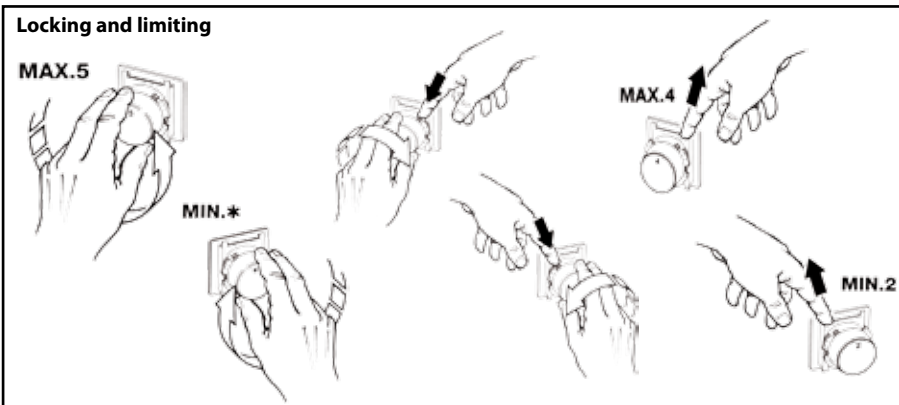
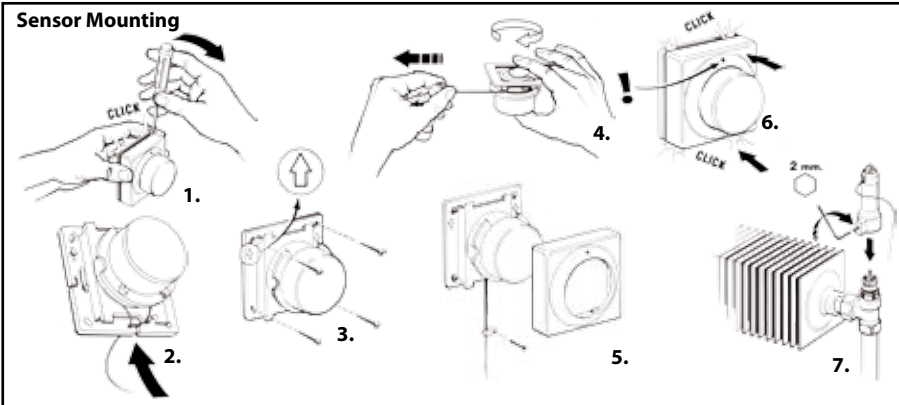

Additional Information:
www.danfoss-randall.co.uk





Summary

- Straight or angled versions
- Use in 1 or 2 pipe systems
- Maximum flow temperature 120°C
- Maximum working pressure 10 bar

Lockshield Valves With Drain Off

The RLV range of lockshield valves match the finish and style of RA-G, RA-FN and RA-N valve bodies. They are available in vertical angle and straight pattern versions in 3/8", 1/2" and 3/4" sizes for screwed pipe-work and 15mm for copper pipe-work.

Adjustment of the valve is made using a 6mm Allen key. Once set, a screw-on brass cover

conceals the valve setting mechanism.

In addition to providing a balancing and isolation function, RLV lockshield valves also incorporate a drain-down / filling feature. To utilize this feature a drain-off accessory is mounted to the valve in place of the decorative cap. The system can then be drained down or filled by connecting a hose to the drain down adaptor.

RLV Commercial Lockshield Valves				
Pattern	Type	Code No	Connection Sizes	
			Pipe	Radiator
Vertical Angle	RLV 10	003L014100	3/8"	3/8"
	RLV 15	003L014300	1/2"	1/2"
	RLV 15	003L014315	15mm	1/2"
	RLV 20	003L014500	3/4"	3/4"
Straight	RLV 10	003L014200	3/8"	3/8"
	RLV 15	003L014400	1/2"	1/2"
	RLV 15	003L014415	15mm	1/2"
	RLV 20	003L014600	3/4"	3/4"

Drain-cock Adaptor and Compression Fittings for RLV Series Valves

Code No	Description
003L015200	Drain-cock adaptor for use with RLV models only, not RLV-S

Specification

Maximum working pressure	10 Bar
Maximum working temperature	120°C
Test pressure	16 Bar
Valve body finish	Nickel Plated
Gland seal type	Double O-ring
Supplied with LSV cap (nickel plated brass)	Yes
Supplied with wheel head cap	No

Dimensions

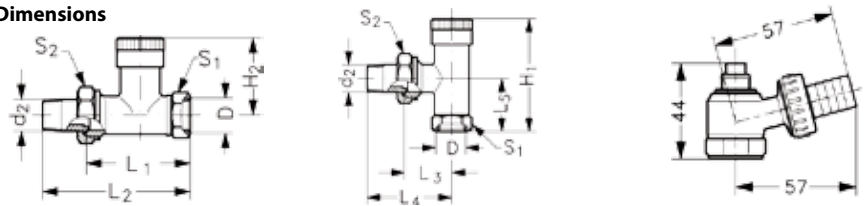

Type	D	d ₂	H ₁	H ₂	L ₁	L ₂	L ₃	L ₄	L ₅	S ₁	S ₂
RLV 10	R _p 3/8	R _p 3/8	55	40	49	75	26	52	22	22	27
RLV 15	R _p 1/2	R _p 1/2	59	40	51	80	29	58	27	27	30
RLV 20	R _p 3/4	R _p 3/4	62	42	59	91	34	66	30	32	37

Use of Drain Cock Adaptor

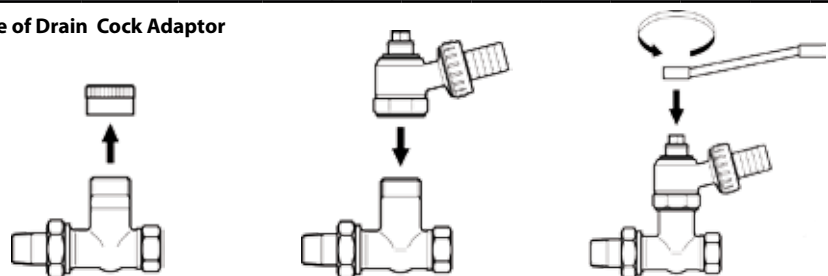

RLV 15 Straight



Drain Cock Adaptor



RLV 15 Vertical



Additional Information:

See p. 18 for Compression Fittings for Copper, PEX and ALUPEX pipe

Lockshield Valves Without Drain Off

The RLV-S range of lockshield valves match the finish and style of RA-G, RA-FN and RA-N valve bodies. They are available in vertical angle and straight pattern versions in 3/8", 1/2" and 3/4" sizes for screwed pipe-work and 15mm for copper pipe-work.

Adjustment of the valve is made using a 6mm Allen key. Once set, a screw-on brass cover conceals the valve setting mechanism.

The RLV-S does not incorporate a drain down feature.



Summary

- Straight or angled versions
- Use in 1 or 2-pipe systems
- Maximum flow temperature 120°C
- Maximum working pressure 10 bar

RLV-S Commercial Lockshield Valves				
Pattern	Type	Code No	Connection Sizes	
			Pipe	Radiator
Vertical Angle	RLV-S 10	003L012100	3/8"	3/8"
	RLV-S 15	003L012300	1/2"	1/2"
	RLV-S 15	003L012315	15mm	1/2"
	RLV-S 20	003L012500	3/4"	3/4"
Straight	RLV-S 10	003L012200	3/8"	3/8"
	RLV-S 15	003L012400	1/2"	1/2"
	RLV-S 15	003L012415	15mm	1/2"
	RLV-S 20	003L012600	3/4"	3/4"
Specification				
Maximum working pressure			10 Bar	
Maximum working temperature			120°C	
Test pressure			16 Bar	
Valve body finish			Nickel Plated	
Gland seal type			Double O-ring	
Supplied with LSV cap (nickel plated brass)			Yes	
Supplied with wheel head cap			No	

Dimensions

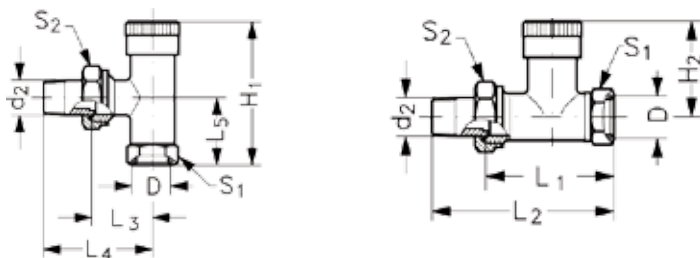

Type	D	d ₂	H ₁	H ₂	L ₁	L ₂	L ₃	L ₄	L ₅	S ₁	S ₂
RLV-S 10	G _p 3/8	R _p 3/8	42	26	51	75	27	51	23	22	27
RLV-S 15	G _p 1/2	R _p 1/2	52	28	53	80	30	57	27	27	30
RLV-S 20	G _p 3/4	R _p 3/4	52	28	61	92	34	65	30	32	37



RLV-S 15 Vertical



RLV-S 15 Straight

Additional Information:
See p. 18 for Compression Fittings for Copper, PEX and ALUPEX pipe

Danfoss



Summary

- Lockshield valve function
- Straight or angled versions
- Use in 2 pipe systems
- Self sealing radiator connection
- Maximum flow temperature 120°C
- Maximum working pressure 10 bar

RLV-KD H-Pieces With Drain Off

Some radiator manufacturers now produce radiators with integrated radiator thermostats. Generally the connections on such radiators are located on the bottom of the radiator spaced at an industry standard of 50mm.

RLV-KD H-Pieces allow system pipe-work and radiators to be conveniently connected to copper, PEX or ALUPEX pipe systems. Radiator connections are normally either 1/2" internal or 3/4" external threads and versions of the RLV-KD are available for both standards.

RLV-KD H-Pieces incorporate a balancing feature and provide isolation of both flow and return connections essential for radiator removal. The valves are available for both bottom entry or rear entry pipe-work, see order table for details.

RLV-KD also provides a drain down/system filling feature by means of a drain down adaptor, see order table for details.

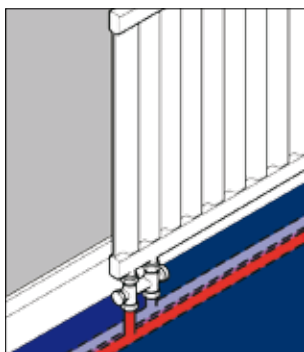
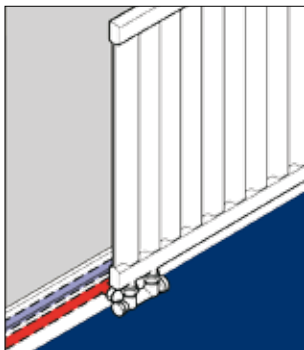

RLV-KD Bottom Connection

RLV-KD H-Pieces with drain facility ⁽¹⁾	
Code No	Description
003L024000	Bottom connection for use with radiators having 1/2" internal connections
003L024200	Back connection for use with radiators having 1/2" internal connections
003L024100	Bottom connection for use with radiators having 3/4" external connections
003L024300	Back connections for use with radiators having 3/4" external connections
Accessories for H-Pieces	
003L015200	Drain-cock adaptor for use with RLV-KD H-pieces
<i>Please note: (1) order pipe fittings separately, see page 18</i>	

Dimensions

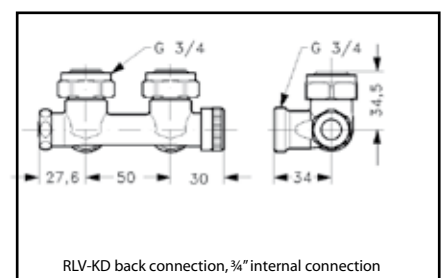
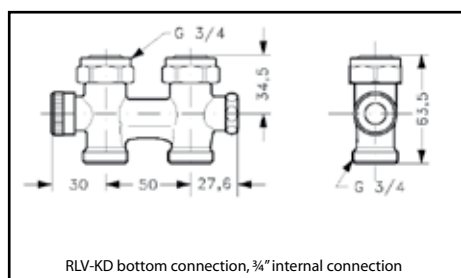
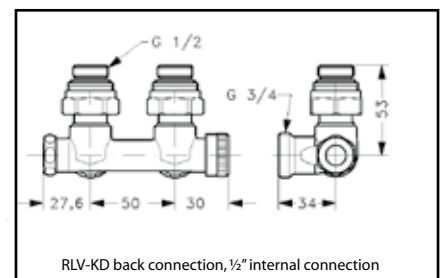
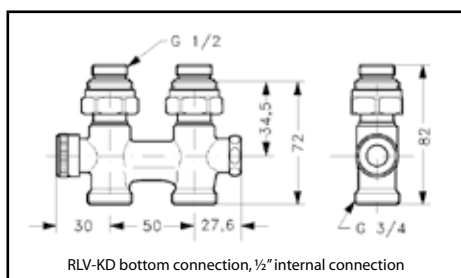

Additional Information:

See p. 18 for Compression Fittings for Copper, PEX and ALUPEX pipe

RLV-KS Without Drain Off

RLV-KS H-Pieces allow system radiators with 50mm center connections to be conveniently connected to copper, PEX or ALUPEX pipe systems. Radiator connections are normally either 1/2" internal or 3/4" external threads and versions of the RLV-KSD are available for both standards.

RLV-KS H-Pieces incorporate a balancing feature and provide isolation of both flow and return connections essential for radiator removal. The valves are available for both bottom entry or rear entry pipe-work, see order table for details.

RLV-KS does not provide a drain down facility.



Summary

- Lockshield valve function
- Use in 2-pipe systems
- Straight or angled versions
- Self sealing radiator connection
- Maximum flow temperature 120°C
- Maximum working pressure 10 bar

RLV-KS H-Pieces without drain facility ⁽¹⁾	
Code No	Description
003L022000	Bottom connection for use with radiators having 1/2" internal connections
003L022200	Back connection for use with radiators having 1/2" internal connections
003L022100	Bottom connection for use with radiators having 3/4" external connections
003L022300	Back connections for use with radiators having 3/4" external connections

Please note: (1) order pipe fittings separately, see page 18

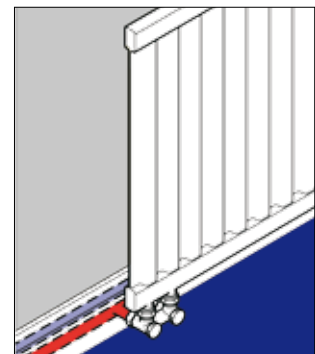

Dimensions

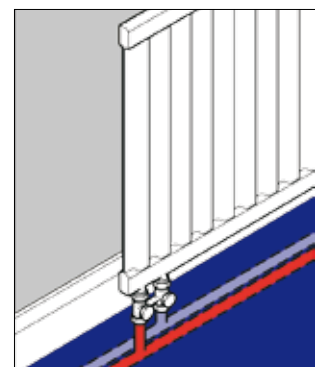
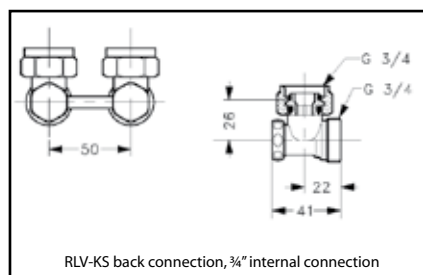
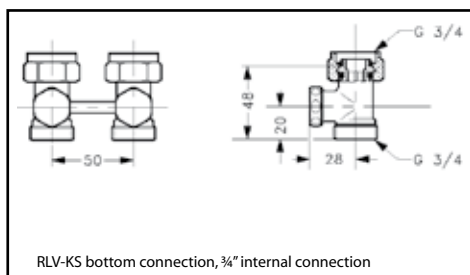
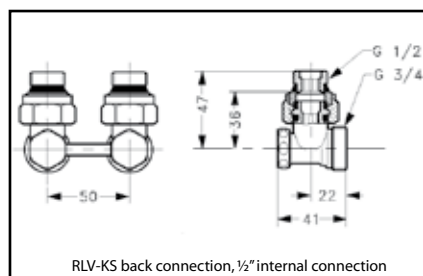
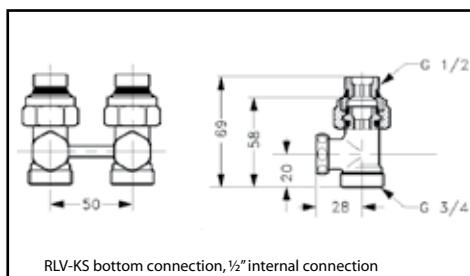

RLV-KS Back Connection

Additional Information:
See p. 18 for Compression Fittings for Copper, PEX and ALUPEX pipe



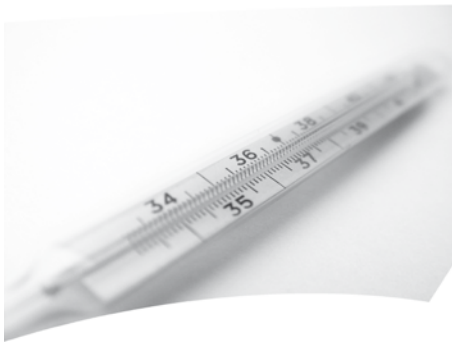

Copper Fittings

For Copper, PEX & ALUPEX Pipe

For Valves with Female Threaded Connections	
Compression Fittings for:	RA-FN, RA-N Radiator Thermostat Valve Bodies, RLV and RLV-D Lockshield Valve Bodies, RA-URX Towel Rail Valve Bodies, FJVR Return Temperature Limiter Valve Bodies and KOVM 3-Port Valve Bodies
Pipe Type:	Copper
013G410000	3/8" x 10mm
013G410200	3/8" x 12mm
013G410800	1/2" x 8mm
013G411000	1/2" x 10mm
013G411200	1/2" x 12mm
013G411500	1/2" x 15mm
Pipe Type:	PEX
013G414200	1/2" x 12 x 0.2mm
013G414400	1/2" x 14 x 2.0mm
013G414700	1/2" x 15 x 2.5mm
013G415600	3/4" x 16 x 2.0mm
Pipe Type:	ALUPEX
013G417200	1/2" x 12 x 2mm
013G417400	1/2" x 14 x 2mm
<i>Please note: Copper pipe must be in accordance with BS2871 part 1/BSEN1057. It is recommended to use supporting bushes with soft copper pipes. PEX pipe must be in accordance with DIN16892/16893 or BS7291 part 1:1990 or part 3:1990. Maximum operating pressure and temperature are given by the pipe manufacturer. However, 6 bar and 95°C must not be exceeded.</i>	
<i>Design: For use with valves having a female threaded connection. Fitting comprises olive and externally threaded compression nut, dimension of female thread is included in the description. For PEX and ALUPEX a pipe support insert is also included.</i>	

For Valves with Male Threaded Connections	
Compression Fittings for:	RLV-KD AND RLV-KS H-Pieces, VHS H-Pieces, FHV-R and FHV-A Underfloor Heating Valves, CFD Manifolds, RA-C Climate Valves and VMT- 2-Port Valves
Pipe Type:	Copper
013G412000	3/4" x 10mm
013G412200	3/4" x 12mm
013G412500	3/4" x 15mm
Pipe Type:	PEX
013G416500	3/4" x 15mm x 1.7mm
013G415500	3/4" x 15mm x 2.5mm
013G416300	3/4" x 16mm x 2.2mm
013G415900	3/4" x 18mm x 2.5 mm
013G416100	3/4" x 20mm x 2.5mm
Pipe Type:	ALUPEX
013G418400	3/4" x 14mm x 2.0mm
013G418500	3/4" x 15mm x 2.5mm
013G418600	3/4" x 16mm x 2.0mm
013G418800	3/4" x 18mm x 2.0mm
013G419000	3/4" x 20mm x 2.0mm
<i>Please note: Copper pipe must be in accordance with BS2871 part1/BSEN1057. It is recommended to use supporting bushes with soft copper pipes. PEX pipe must be in accordance with DIN16892/16893 or BS7291 part 1:1990 or part 3:1990. Maximum operating pressure and temperature are given by the pipe manufacturer. However, 6 bar and 95°C must not be exceeded.</i>	
<i>Design: For use with valves having a 3/4" male threaded connection. Fitting comprises olive and internally threaded compression nut. For PEX and ALUPEX a pipe support insert is also included.</i>	



ALUPEX Fittings Internal/External



Copper Fittings Internal/External



PEX Fittings Internal/External



Additional Information:
www.danfoss-randall.co.uk

Spare Parts and Accessories

Gland Seals

All gland seals in Danfoss radiator thermostats are designed to provide a long and trouble free in-service life. However, periodically it may be necessary to replace seals should failure occur. All valves produced by Danfoss since early 1960's incorporate gland seal assemblies which can be replaced without draining down the system.

Tool Kit

The tool kit contains a convenient hexagonal drive screwdriver for fitting and removing RA2000 sensors from their respective valve bodies. The tool kit also contains a special threaded end screwdriver for use with the special tamperproof locking pins supplied with RA2000 tamperproof sensors.

Valve Adaptor

Adaptors to convert RA2000 remote temperature adjusters for use with RAV and RAVL bodies already installed.

Manual Positive Shut-Off Knob

The RA manual positive shut-off knob fits onto all valve bodies in the RA Series and can be used for manual opening and closing of the valve.

Replacement Sensors

Replacement sensors incorporate RA2000 sensor technology and design, and provide a simple and straight forward way to upgrade older radiator thermostats without the need to drain down the system.



Summary

Gland Seal

- Just 2 gland seals cover the whole range of Danfoss valves
- Can be replaced without draining down system

Replacement Sensor

- Allows easy up-grade of old valves without the need to drain down
- Versions available for RAVL & RAV valve bodies
- Available in built-in and remote sensor versions

Gland Seals					
Code No	Description				
013G029000	Gland Seal Assembly for RA-FS, RA-FR, RA-FN, RA-N and RA-G Valves				
013U007000	Gland Seal Assembly for RAV and RAVL Valves				
Accessories for RA2000 Sensors and Valves					
Code No	Description				
013G123200	Anti-Theft for Sensors (50 pieces)				
013L123400	Range Displacement Caps (20 pieces)				
013G123700	Threaded Range Limiting pins (30 pieces)				
013G123300	RA2020 Scale Cover (20 pieces)				
013G123600	Toolkit, comprising Allen Key & Locking Pin Tool				
013G123000	Accessory Bag for RA2000 Remote Sensor Base, Fixing Screw & Capillary Caps				
Accessories for RA2000 Remote Adjusters					
013G519300	Adaptor for RA5062, 5065 & 5068 for RAV Valves				
013G519200	Adaptor for RA5062, 5065 & 5068 for RAVL Valves				
Accessories for RA-FS, RA-FN, RA-N & RA-G Valves					
Code No	Description	RA-FS	RA-FN	RA-N	RA-G
013G500000	Manual Positive Shut-Off Knob	•	•	•	•
013G500100	Blanking Cap for Valve Outlet	•			
013G027500	Spare Protective Cap	•	•	•	•

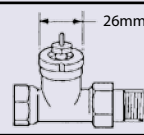
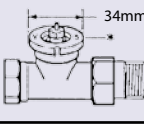
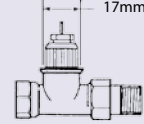
RA2000 Replacement Sensors and Gland Seals						
Existing Valve Body Dimensions	Existing Valve Body Type	Replacement Sensor - please note: the Code No's have changed				
		New Code No	Old Code No	Sensor Type	Description	Temp Range (Xp = 2k)
 26mm	RAVL	013G295000	013G221000	RA/VL	Built-In Sensor	5 - 26°C
		013G295200	013G221200	RA/VL	Remote Sensor 2m Capillary	
 34mm	RAV	013G296000	013G231000	RA/V	Built-In Sensor	5 - 26°C
		013G296200	013G231200	RA/V	Remote Sensor 2m Capillary	
 17mm	RA-FR RA-FS	Refer to RAS-C ² & RAS-D ² Sensors on p.8 and 9				
	RA-FN RA-G RA-N	Refer to RA2000 Sensors on p. 10				



Gland Seals



Valve Adaptor



Manual Positive Shut-Off Knob

Additional Information:
www.danfoss-randall.co.uk



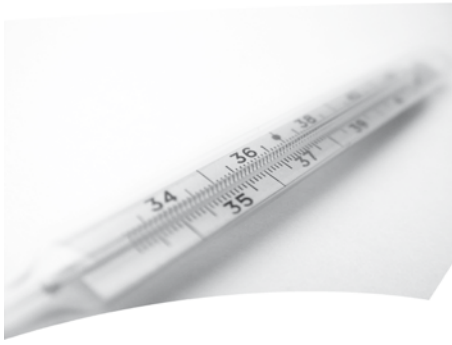

Valve Capacities

Proportional temperature controls try to maintain equilibrium between heat loss and heat input. They react in proportion to any deviation from a set temperature level, until heat input is either completely shut off or is at its maximum. The temperature levels at which this occurs are presettable, and the band between the two levels, measured in K (degrees C), is the proportional band.

RA-N valves with pre-setting

The pre-setting function on RA-N valves limits the maximum flow through the valve, regardless of the radiator thermostat's temperature setting. An adjustable aperture integrated into the valve creates this limitation.

Correctly sized, the maximum flow limitation ensures that each radiator in a heating system - regardless of size - will get exactly the flow necessary to heat up a room - no more, no less. By installing RA-N pre-setting valves the heating system will always be correctly balanced.

The unique pre-setting function makes it possible, as early as the planning stage, to accurately calculate each valve's pre-setting value, thus avoiding the need for temperature drop based commissioning of lockshield valves on site.

No tools are necessary when adjusting the pre-setting. With the sensor mounted it is not possible

to get access to the pre-setting function.

When a room needs to be redecorated, at some later date, it is possible to close the valves and remove the radiator in the normal way.

With the RA-N pre-setting valve it is easy to return to the optimal balance in the heating system, as there is no need to remember any setting on the lockshield valve. Just remount the radiator and open the lockshield valve fully. The pre-setting of the RA-N valve stays correctly adjusted during the whole process.

The capacities shown here are all with a proportional band of 2K and an RA2000 sensor. When using remote temperature adjusters the capacity values must be reduced by 40%.

Please note:

As with any device which imposes a pressure drop in the system, noise may occur under certain flow/pressure conditions. To ensure quiet operation, maximum pressure drop should not exceed 0.3 bar.

RA-N 10 and RA-FN 10 (All models)

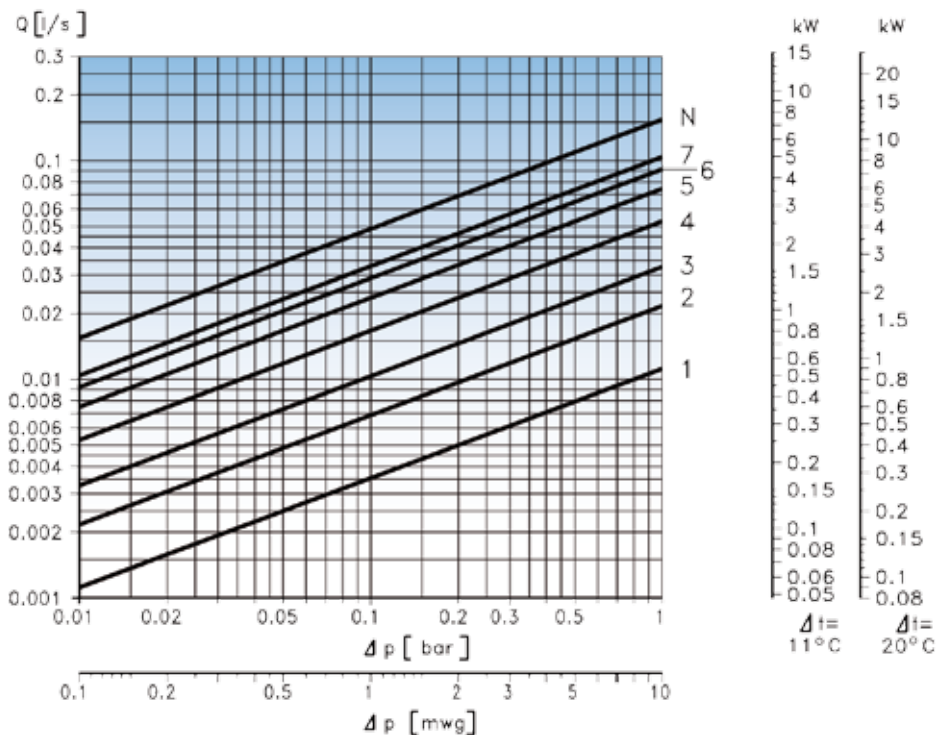

The pre-setting values 7 to 1 only apply for the pre-setting valve RA-N.



Additional Information:
www.danfoss-randall.co.uk

Valve Capacities

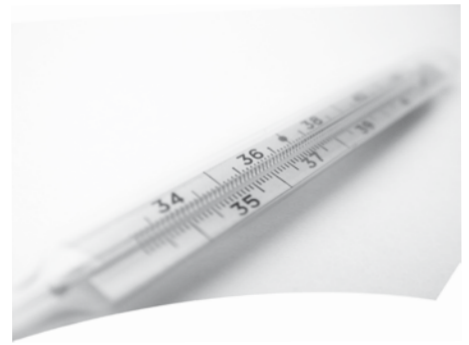

RA-N 15 and RA-FN 15 (All models)

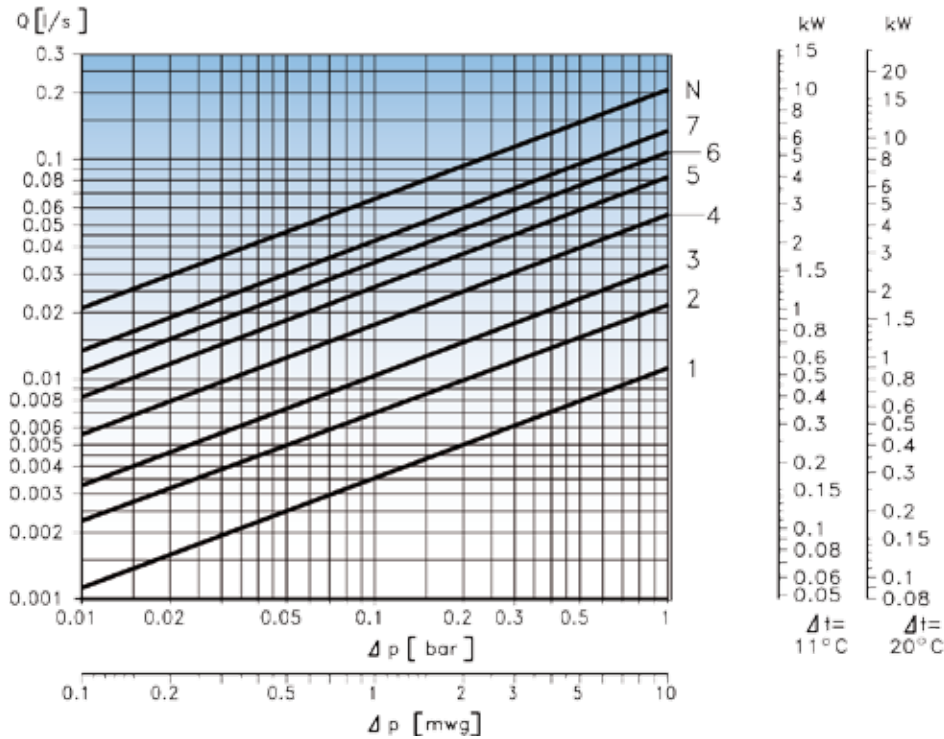

The pre-setting values 7 to 1 only apply for the pre-setting valve RA-N.

RA-N 20/25 and RA-FN 20/25 (Straight and Vertical Angle)

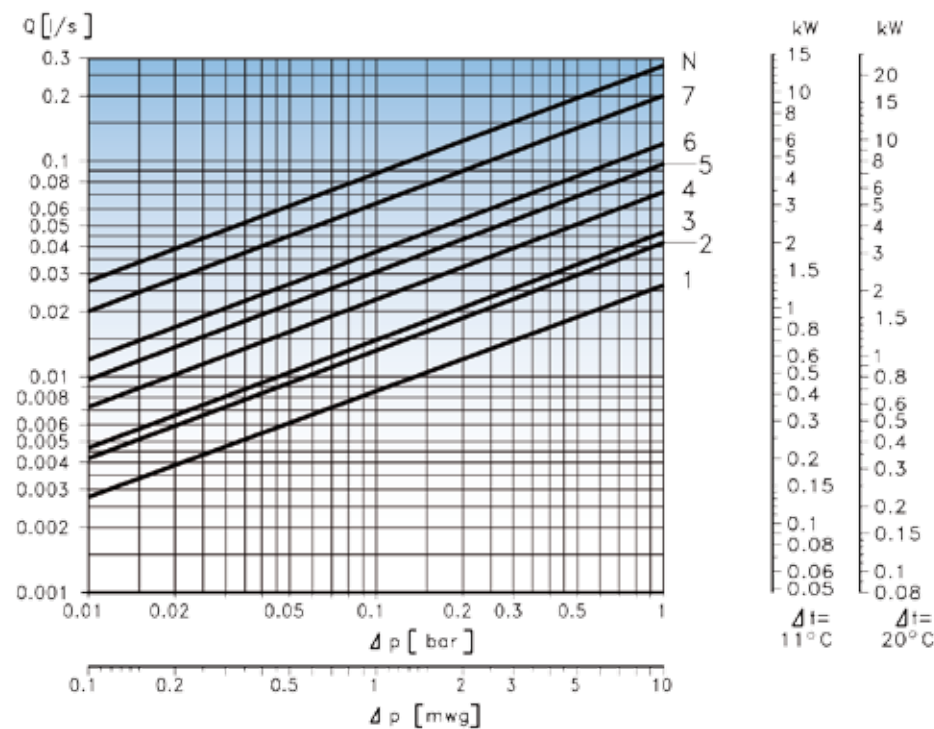

The pre-setting values 7 to 1 only apply for the pre-setting valve RA-N.

Additional Information:
www.danfoss-randall.co.uk





Valve Capacities

RA-N 20 and RA-FN 20 (Horizontal Angle)

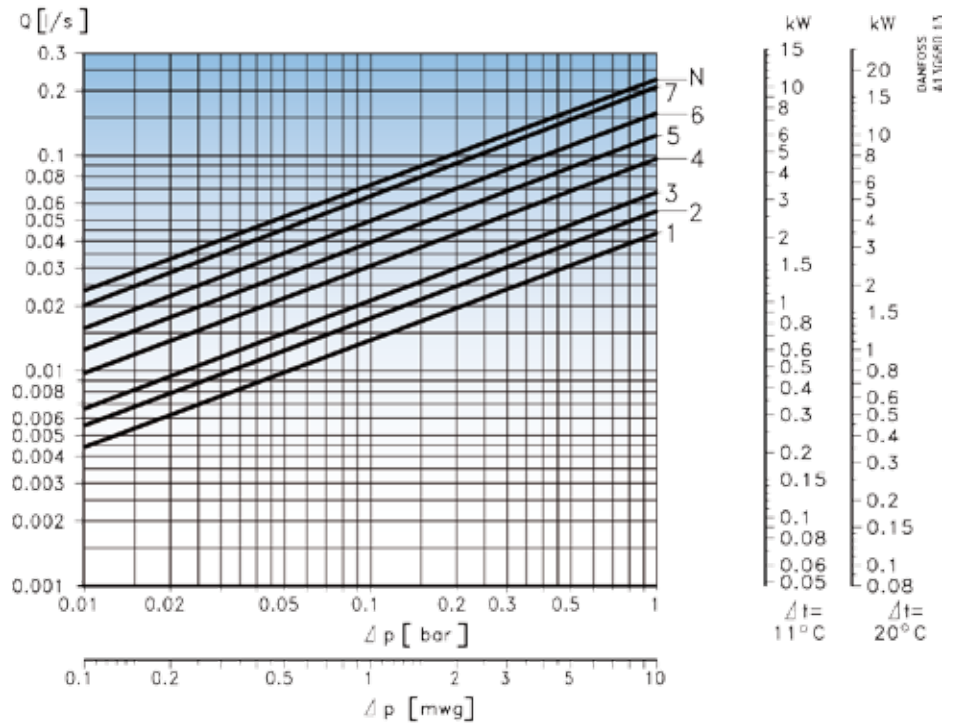

The pre-setting values 7 to 1 only apply for the pre-setting valve RA-N.

RA-G (All models)

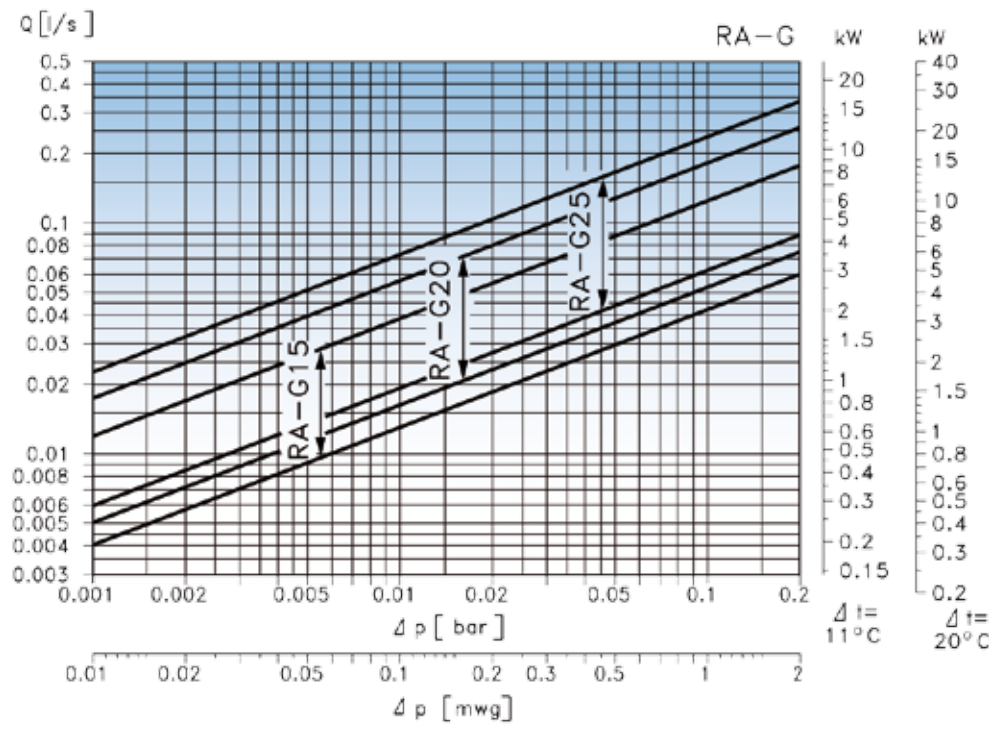

Additional Information:
www.danfoss-randall.co.uk

Commercial Radiator Thermostat Selection Guide



- Approved combination, refer to notes for any restrictions/advice

- 1 Mount sensor horizontally
- 2 Consider use of remote sensor to improve performance
- 3 Remote sensor is recommended
- 4 Valve body flow selector must be commissioned

Description	Built-in Sensors			Remote Sensors (0-2m)			2/5/8m Wall Adjusters
	Standard	Low Temp.	Tamperproof	Standard	Low Temp.	Tamperproof	
Symbol							
Model	RA2910	RA2914	RA2920	RA2912	RA2916	RA2922	RA5062, RA5065, RA5068
Codes	013G291000	013G291400	013G292000	013G291200	013G291600	013G292200	013G506200 013G506500 013G506800
Temp. Range	5-26°C	5-22°C	5-26°C	5-26°C	5-22°C	5-26°C	6-28°C

Valve Options						Sensor Options						
Symbol	Size	Standard Valves		Valves with pre-setting								
		Type	Code No.	Type	Code No.							
	8/10mm	RA-FS 15	013G628300	N/A		• 4	• 4	• 4	• 4	• 4	• 4	• 4
	15mm	RA-FS 15	013G628100	N/A								
	3/8"	RA-FN 10	013G002200	RA-N 10	013G003200							
	1/2"	RA-FN 15	013G002400	RA-N 15	013G003400							
	1/2"/15mm	RA-FN 15	013G008400	RA-N 15	013G0034AA	• 1	• 1	• 1	•	•	•	•
	3/4"	RA-FN 20	013G002600	RA-N 20	013G003600							
	1"	RA-FN 25	013G002800	RA-N 25	013G003800							
	3/8"	RA-FN 10	013G002100	RA-N 10	013G003100							
	1/2"	RA-FN 15	013G002300	RA-N 15	013G003300							
	1/2"/15mm	RA-FN 15	013G0023AA	RA-N 15	013G0033AA	• 2	• 3	• 2	•	•	•	•
	3/4"	RA-FN 20	013G002500	RA-N 20	013G003500							
	1"	RA-FN 25	013G002700	RA-N 25	013G003700							
	3/8"	RA-FN 10	013G014100	RA-N 10	013G015100							
	1/2"/15mm	RA-FN 15	013G014900	RA-N 15	013G015300	•	•	•	•	•	•	•
	3/4"	RA-FN 20	013G014500	RA-N 20	013G015500							
	1/2"	RA-G 15	013G338400	N/A								
	3/4"	RA-G 20	013G338600	N/A		• 1	• 1	• 1	•	•	•	•
	1"	RA-G 25	013G338800	N/A								
	1/2"	RA-G 15	013G338300	N/A								
	3/4"	RA-G 20	013G338500	N/A		• 2	• 3	• 2	•	•	•	•
	1"	RA-G 25	013G338700	N/A								

Additional Information:
www.danfoss-randall.co.uk





Danfoss can accept no responsibility for possible errors in catalogues, brochures and other printed material. Danfoss reserves the right to alter its products without notice.

Danfoss