

JG Speedfit®

UNDERFLOOR

THE PUSH-FIT SOLUTION FOR UNDERFLOOR HEATING

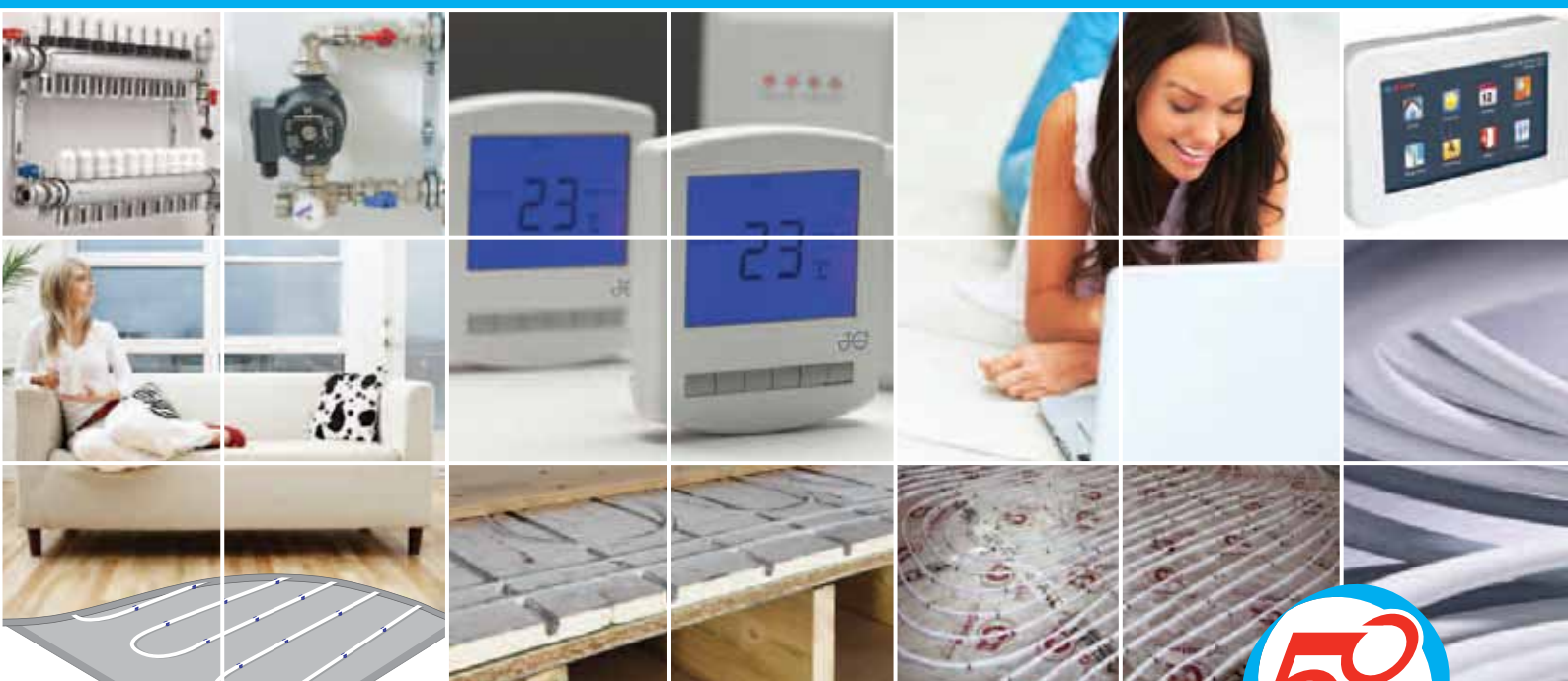

Celebrating 50 Years of Innovation



Includes these NEW additions:

- **Overlay Heating System**
- **Manifolds**
- **Wireless Heating Control System**
- + **Many More**

Underfloor Heating Systems

Energy Saver System

MARCH 2011

Worldwide Connections

The John Guest Group has a long established reputation as a world leading manufacturer of push-in fittings, tube and other fluid control products. A reputation built on producing consistently high quality products with an ongoing commitment to value engineering and product development.

The Speedfit System for Underfloor Heating has been designed to be as quick and easy as possible to install with component parts manufactured under an ISO9001 Quality Management System.

The System has water pumped from a boiler or other heat source to a pump pack where it is mixed to approximately 50°C then distributed via a manifold to heating circuits made using Speedfit Barrier Pipe. The

temperature and volume of water altered to maintain the requirements of the system.

The pipe is laid in concrete or suspended just below the surface of timber flooring.

A wide range of electrical components means the system can have as much or as little control as required.

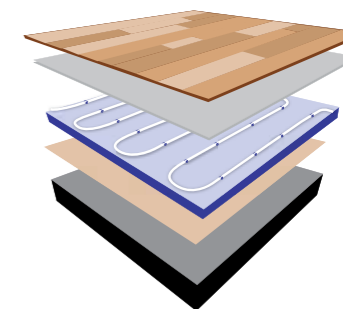

Quality Manufacture

A commitment to quality is at the heart of the John Guest Philosophy

The strictest control is maintained by virtue of the fact that design and manufacture is carried out in modern purpose built manufacturing centres in west London and at Maidenhead in Berkshire.

Maintaining control over the whole process from initial tool design and tool making through to final assembly and testing ensuring that only products of the highest quality are produced.

The company believe it is this commitment to quality that has led to it receiving prestigious awards from many of the world's leading testing and approvals organisations.

John Guest is a preferred supplier to many international companies.

Design Service and Technical Support

CAD Design Service

Members of the Technical Support Team are available to help you get the best from your Speedfit Underfloor Heating System.

To obtain an estimate send us a plan of the area where underfloor heating is required, indicating the preferred location of the manifold and intended floor finishes.

An estimate will be prepared and when approved and an order placed, the Speedfit CAD Design Service will provide a detailed drawing showing pipe layout, flow rates, suggested zone temperatures and advice

on commissioning.

A member of our national team of Technical Support Engineers will be available to offer on-site support during the installation process.

Technical Help Desk:
01895 425333

The JG Speedfit Technical Advisory Service is available to assist and advise on all aspects of using the Speedfit System. The service is available between 8.00am and 5.00pm Monday to Friday.



Contents

Low Voltage Network Control System

A new Network Control System which is both easy to install and reliable, with slimline and attractive components.
 The basic system of Programmable Room Thermostats and Wiring Centre can be enhanced by a number of upgrade options.

PROGRAMMABLE ROOM THERMOSTATS AND WIRING CENTRE

Two models of Programmable Room Thermostats. Both offer 5 day/2 day or 7 day programming, one has hot water timer facility.
 An 8 zone Wiring Centre used to connect the wiring from thermostats, actuator valve, boiler and pump and manage the control of the network.

Page 10



TOUCH SCREEN THERMOSTAT OPTION

A range of easy to use deluxe Touch Screen Programmable Room Thermostats make user manuals a thing of the past.

Page 11



TOUCHPAD CENTRAL CONTROLLER OPTION

Control up to 32 thermostats from one central location using easy touch screen control.

Pages 12 and 13



SOFTWARE OPTIONS

Control your underfloor heating from a home computer, via the internet or from a mobile phone.

Pages 14 and 15

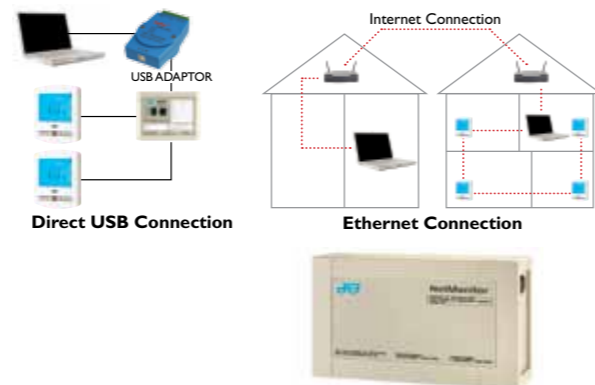

Mains Voltage Electrical Control System

Slimline and attractive components with a Touch Screen Time Clock and a choice of room thermostats.

Pages 16 and 17



Wireless Control System

Slimline and attractive components which are easy to install and reliable with upgrade options.

Pages 18 and 19



System Components

Manifolds, pumps, pipe fixing systems and much more to help you complete your installation.

Pages 20 and 21

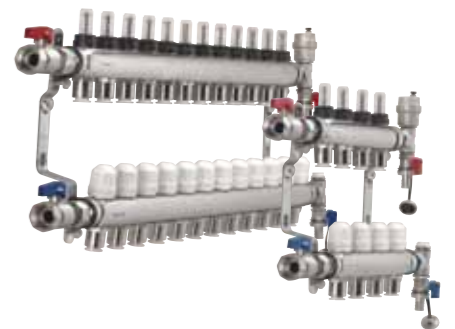

Underfloor Heating for Conservatories and Extensions

Single Room Control Units, Underfloor Heating Packs - everything you need to install a system of up to 30sqm.

Pages 22 and 23



Installation Guides

Easy to follow guide on completing your installation.

Pages 24 to 31



Energy Saver System

A radiator system with individual zone control.

Pages 32 and 33



Underfloor Heating

Underfloor heating provides the most comfortable even warmth of any heating system. It is economical to run and virtually maintenance free.

The Speedfit System has water being pumped from a boiler to a pump pack, where it is mixed to approximately 50°C then distributed via a manifold to heating circuits made using Speedfit Barrier Pipe. The pipe is laid in concrete or suspended just below the surface of the floor.

In concrete floors, the pipe is laid on insulation and then covered with a

screed on which can be laid almost any type of floor covering.

For timber floors, spreader plates are laid between the joists and the floor decking or on the underside of the floor. Speedfit Pipe is pushed into the grooves on the plates.

The floor area is typically warmed to between 25°C and 28°C, providing an even distribution of heat at only slightly higher than room temperature. The system is controlled by one or more thermostats which signal the Pump Pack when heat is required.

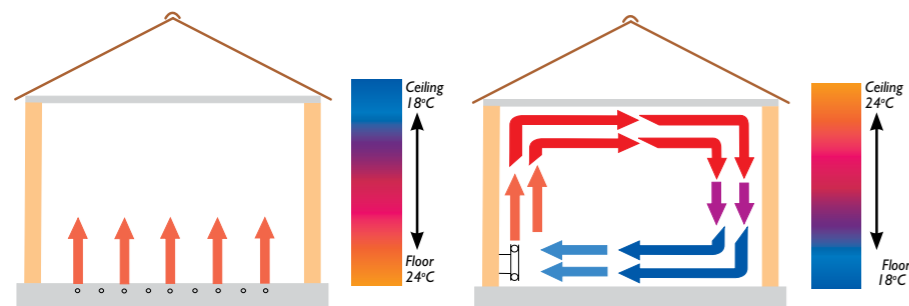

The heat is concentrated where it is most needed for comfort and efficiency.

By contrast, radiators transfer heat from a relatively small area at a much higher temperature than the space being heated.

The radiator system heats mainly by convection. This results in the floor being the coolest place in the room, with the mass of warm air at ceiling level.



The Whole Floor Acts as a Heat Source

FEATURES & BENEFITS

The Speedfit Underfloor Heating System offers many benefits to the consumer. These include:

Installation

It is simple to install, requiring the minimum of installation effort and little maintenance.

Comfort

The system uses radiant heat, the most comfortable form of heating, giving an even distribution of warmth over the whole room.

Space

The system is unobtrusive and space saving which means every square metre of floor and wall space can be utilised giving freedom of interior design.

Noise

Compared to radiator systems the system is virtually silent running.

Health

Dust is minimised reducing the problem of house dust mites. Reduced numbers of hot surfaces and sharp edges minimise risk of burns or injury.

Efficiency Savings

Underfloor Heating Systems are designed to operate at lower temperatures than radiator systems, making them especially suitable for condensing boilers, resulting in reduced energy consumption and lower heatloss from the building structure.

Control

The system is easy to control and the small temperature difference between the floor and air means the system is virtually self-regulating.

Environment

Underfloor heating is suitable for use with the most energy efficient and environmentally friendly heating systems including condensing boilers, solar power and heat pumps.

FLOOR FINISHES AND COVERING

The Speedfit Underfloor Heating System is suitable for most floor finishes, including ceramic tiles, carpets, vinyl and laminate.

The thermal resistance of floor covering will have a marked effect on the performance of the heating system.

Advice on the use of floor coverings and their effect on the performance of a system is available from our Technical Help Desk.

SET BACK - EXPLAINED

Compared to other forms of heating, underfloor heating has a relatively slow response time, taking longer to heat up and cool down than say radiator systems.

In order to reduce running costs and to have realistic heat up and cool down response times, rather than the system being switched off, the temperature setting is reduced by about 4°C. This is called set back because the system is turned down not off.

With the Speedfit System, set back can be achieved in two ways.

Individual Programming

Programmable Room Thermostats can be installed in each zone. They give individual time and temperature control, alternating between daytime and set back temperatures.

Centralised Programming

The Dial Set Back Room Thermostat has its own 'Daytime' and 'Set Back' time controlled centrally using a Touch Screen Time Clock.

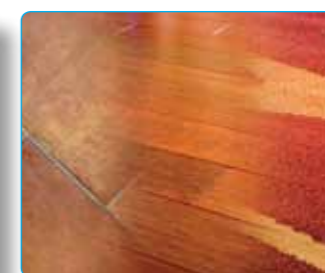

Network Control System (Low Voltage)

- Easy to install and use
- Reliable
- Slimline, attractive components
- With upgrade options

- A range of de luxe Touch Screen Programmable Room Thermostats.
- Direct control, of the whole system from a central TouchPad Controller.
- Software options to give direct control from a PC, via the internet or from a mobile phone.

The new Underfloor Heating Network Control System from JG Speedfit differs from a normal underfloor heating system in that low voltage electrical components are 'networked' together using computer network cable*, this one cable carrying signals between a wiring centre and all the components. This system enables programming of time and temperature for individual rooms to be carried out directly at the room thermostat or centrally by choosing from a number of upgrade options:-

*CAT5 cable is similar to telephone cable and used as computer network cable.

Beldon cable is best described as a heavier duty version of CAT5, it is easier to use than CAT5 and we would recommend Beldon cable be used on all installations.

However, if using CAT5 cable, ensure it is the shielded type. It is important to connect Y and B (Yellow and Blue) communication cables using two strands from a twisted pair.

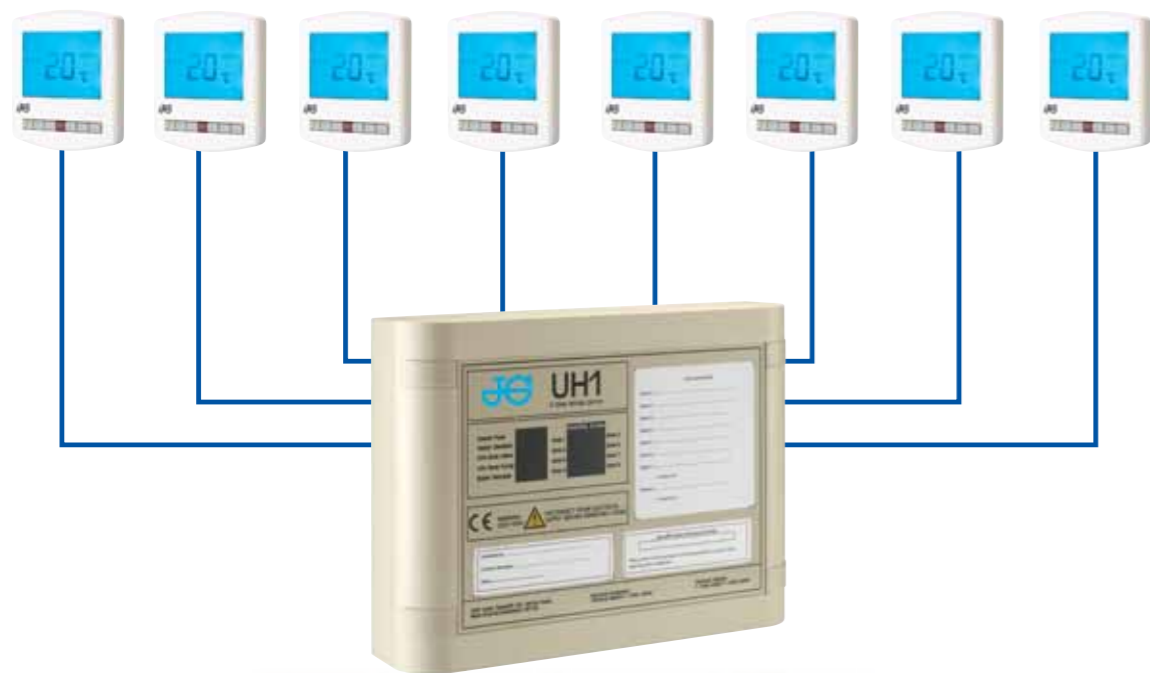

Network Control System (Low Voltage)

PROGRAMMABLE ROOM THERMOSTAT



Part No.	Description
JGSTAT/V3	PROGRAMMABLE ROOM THERMOSTAT

Room Thermostat which can be programmed in either 5 day/2 day or 7 day mode. Offers the facility of up to 4 different temperature settings per day. The thermostats are multi functional and are self learning. This means that to avoid unnecessary use of energy, the thermostat will delay the heating start up until the last possible moment needed to achieve the comfort level at the programmed time.

Can also be controlled using a TouchPad or PC or remotely using a PC with an internet facility.

The thermostat also has the facility to connect to 2 remote probes (JGPROBE).

PROGRAMMABLE ROOM THERMOSTAT PLUS HOT WATER CONTROL



Part No.	Description
JGSTATPLUS/V3	PROGRAMMABLE ROOM THERMOSTAT

Room Thermostat which can be programmed in either 5 day/2 day or 7 day mode with an additional program for domestic hot water. Thus, hot water can be set to give 4 different timed control periods.

Can also be controlled using a TouchPad or PC or remotely using a PC with an internet facility.

Note there is no remote probe facility with this model.

REMOTE PROBE & SENSOR BOX



Part No.	Description
JGPROBE	REMOTE PROBE
JGSENSOR	SENSOR BOX

Use with a JGSTAT/V3 or a Touchscreen Thermostat

Used in conjunction with a thermostat to control temperature in another room or to control floor temperature.

When using an air sensor, install with a JGSENSOR Sensor Box.

8 ZONE WIRING CENTRE



Part No.	Description
JGUH1	8 ZONE WIRING CENTRE

Offers a simple solution for the control of underfloor heating hot water and radiator circuits that can all be wired to one central base. This also brings the benefit of TouchPad or internet control to radiators and hot water as well as to underfloor heating.

Actuators, boiler and pump connections are wired to a single point. Used in conjunction with our Network thermostats and ideally installed near to the manifold, the Wiring Centre provides individual control of up to 8 zones plus hot water.

Neons show Power, Water, Pump, Boiler and Motorised Valve.

Network Touch Screen Range

The JG Speedfit Touch Screen Range of deluxe Touch Screen Programmable Room Thermostats which can be used alongside other network products allowing remote

programming from options such as TouchPad, Home PC, the internet or mobile phone giving ultimate control over your heating system. The intuitive, easy to use touch

screen display makes the user manual a thing of the past.

TOUCH SCREEN NETWORK ROOM THERMOSTAT



Part No.	Description
JGSTAT/TS/V3	TOUCH SCREEN NETWORK ROOM THERMOSTAT

Can be used in 5 day/2 day mode or a 7 day mode to allow for different time settings for each day of the week, giving total user flexibility.

The Thermostat is self-learning. To avoid unnecessary use of energy, the thermostat can be set to optimum start, delaying the heating start up to achieve the comfort level at the programmed time.

Includes a holiday function, which reduces to a frost setting over the holiday period and reverts back to comfort level to coincide with your return. The frost protection feature has an adjustable temperature setting.

The Thermostat has the facility to connect to either an air or floor probe (JGPROBE).

TOUCH SCREEN NETWORK ROOM THERMOSTAT PLUS HOT WATER CONTROL



Part No.	Description
JGSTATPLUS/TS/V3	TOUCH SCREEN NETWORK ROOM THERMOSTAT

Has all the features of the JGSTAT/TS/V3 plus the additional programme for domestic hot water. The hot water feature can be set to give 4 different time control periods per day.

TWIN CHANNEL TOUCH SCREEN NETWORK ROOM THERMOSTAT



Part No.	Description
JGSTAT2/TS/V3	TOUCH SCREEN TWIN CHANNEL NETWORK ROOM THERMOSTAT

Brings the sophistication of touch screen technology at a similar cost to using dial thermostats by reducing the number of thermostats required in a property.

The 2 channel facility allows one thermostat to control 2 zones at the touch of the thermostat's screen. This makes it perfect for a bedroom with ensuite or living room and dining room.

Zone 1 uses the built in air sensor to control the room it is fitted in, whilst zone 2 uses the remote sensor provided to control an adjacent room. The 2 zones can be up to 20 metres away from each other.

The 2 channels significantly reduce installation time and cost by reducing the amount of wiring and associated labour, while giving the user a simpler and less cluttered look.

NETWORK TOUCH SCREEN THERMOSTAT FEATURES

- 4 Heating Levels
- Optimum Start
- Holiday Function
- Keylock Function
- Temperature Hold Function
- Temperature Override
- Frost Protection

TouchPad Option **NEW**

Control up to 32 zones

TOUCHPAD NETWORK CONTROLLER



The Touchpad can be used to control up to 32 zones.

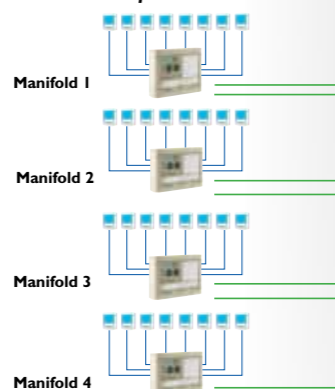







Part No.	Description
JGTOUCHPAD/TFT	TOUCHPAD NETWORK CONTROLLER

The TouchPad features an easy touch screen control of up to 32 zones of heating. You are able to name each thermostat allowing easy identification of each thermostat in the network, remotely program the comfort levels of all networked thermostats from one central point. Program settings can be copied from one thermostat to another.

Also has the option of being able to control the hot water and radiator circuits.

TFT Display - New Features

New TFT LCD offering a greatly improved viewing angle and display resolution.

-  **v3 Compatible** - The New TFT Touchpad is compatible with v3 thermostats
-  **Group Feature** - Allows the user to group thermostats, for use with Profile function.
-  **Profile Feature** - Allows the user to pre-program a set of comfort levels, apply them to a group of thermostats and store against a profile name. When the profile is run, the thermostats in the group receive the new comfort levels.
-  **Zone Link Facility** - Linked zones appear as a linked button, meaning that programmed comfort levels are sent to all of the linked zones.
-  **USB Function**
 - Ability to import pictures (for screensaver operation)
 - Export of history data
 - Update of firmware via Internet Download
-  **Heat/Cool Function** - An upgrade will provide control for underfloor heating and cooling. This firmware update will provide dew point control.
-  **Language Function** - Dutch, German, French and English will be supported.



Network Software Options

The software options allow the user the luxury of convenient control of the heating system.

- Direct from a home computer
- From a laptop via the internet
- By texting from a mobile phone

SOFTWARE FEATURES

- **Temperature View.** See at a glance the actual and set temperature for each thermostat throughout your building.
- **Program Comfort Level.** Program the comfort level for each thermostat on the network.
- **Override Feature.** Quickly override the set temperature for any thermostat.
- **Keylock.** Lock the keypad remotely to prevent unauthorised alteration of the thermostat settings.
- **Holiday.** Program a holiday period for all or selected thermostats, switches the thermostats into frost mode during this period.

Security
Receive an email and text message when your home alarm is triggered

Heating
Control heating & hotwater over web or SMS

Interior Lighting
Turn on or off your interior lighting whilst you are away by SMS or web

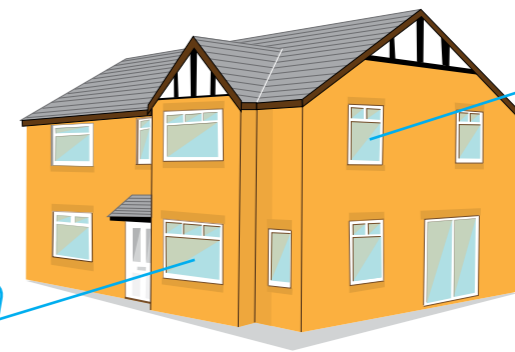

Temperature Alarm
Receive low and high temperature alarms by email or SMS

Outdoor Lighting
Turn on or off your lighting either over the internet or SMS

PC NETWORK SOFTWARE



Part No.	Description
JGPCLITE	PC NETWORK SOFTWARE

Allows for the control of your UFH System from a remote location, using a PC with broadband internet connection and loaded with the network software.

Can control up to 32 12 Volt Network Thermostats on a Windows based PC, using either a direct USB connection or an Ethernet adaptor.

The Ethernet connection allows you to control your heating thermostats within you home network (LAN) or wireless network (WAN) and also remotely over the internet.



Part No.	Description
JGPCPRO	NETWORK SOFTWARE

The System is as JGPCLITE but allows the control of up to 900 network room thermostats.

Making the System suitable for hotels, nursing homes schools and any situation where the temperature of the facility needs to be controlled from a remote location.

USB ADAPTOR



Part No.	Description
JGUSB	USB ADAPTOR

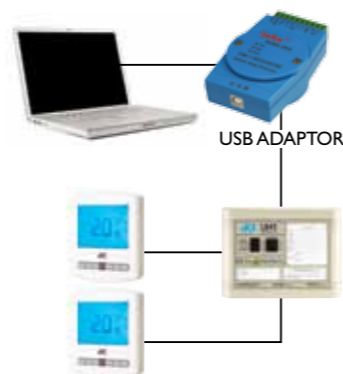

Direct USB Connection

A USB Adaptor that connects directly to a PC that has been loaded with JGPCLITE software so it can 'talk' to the 12-volt network products. The Adaptor can control up to 32 room thermostats.

ETHERNET ADAPTORS

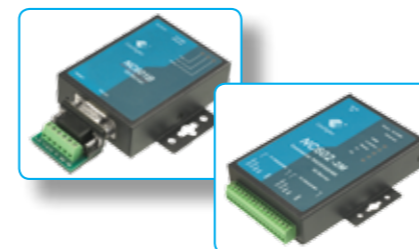

Part No.	Description
JGNETADAPI	1 Port Ethernet Adaptor (controls up to 32 room thermostats)
JGNETADAPI	2 Port Ethernet Adaptor (controls up to 64 room thermostats)

Connects to a PC with JGPCLITE software so it can 'talk' to 12 Volt Network Products. The Adaptor can be connected to a broadband router to enable the PC to 'talk' to the system over the internet.

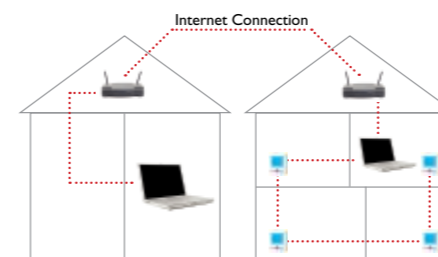

Ethernet Connection

NET MONITOR



Part No.	Description
JGNETMON1	NET MONITOR

With built in software

Allows for communication over the internet from any PC without the need for specialist software to be installed, dialling into the system via the internet using a password.

Used in conjunction with the JGUHI Wiring Centre to allow the user to take control of heating and hot water over the internet from any web browser. Plug the Netmonitor into your home internet router and the built in software allows complete control of the system.

- Program up to 32 12-volt thermostats (JGSTAT) from any internet browser worldwide.
- Connect up to 6-volt free alarms such as home alarms and receive alarm indication on email.
- Control up to 6 appliances remotely via a web browser.
- Connect up to 6 remote temperature sensors to be used for alarm or monitoring.

NET MONITOR - GSM



Part No.	Description
JGNETMON2	NET MONITOR GSM

With built in software

Has the same functions as JGMONI but with an additional GSM facility.

This means the user can control the whole house heating system using text messaging on a mobile phone. The heating can be turned up down, on or off with a few simple text commands. The unit also sends a text message alert as a confirmation. A text message or email can also be sent to alert the owner if there is a fault on the system. Recommended for holiday homes or for people who work away from their property.

- Communicate by email or text message.
- Program up to 32 12-volt room thermostats (JGSTAT) from any internet browser worldwide.
- Connect up to 6 remote temperature sensors to be used for monitoring or alarm purposes.
- Connects up to 6 volt free alarms such as home alarms and receive indications on email or text message.
- Control up to 6 appliances remotely via web browsers or text messaging.

Mains Voltage Controls System

The components in the mains voltage control systems have been designed to work with their respective wiring centres and are not intended to be used with other wiring centres.

- Easy to use
- Easy to install
- Attractive slimline components

Easy to use and install, the John Guest Mains Voltage Controls offer simple but effective control of up to 8 zones. The UH3 Wiring Centre is the hub of the system. It works either in conjunction with our Touch Screen Time Clock and simple to use Dial Setback Thermostats, or, alternatively, our Programmable Room Thermostats. There is also the ability to use both types of thermostat in the same system.

The JGUH3 Wiring Centre has the capability for control of 8 heating zones and integrated connections for underfloor heating zones, boiler, hot water control, Time Clock and the option of a radiator circuit. Having all wiring to one central point makes the JGUH3 much easier to wire up than a conventional underfloor heating wiring centre.

TOUCH SCREEN TIME CLOCK



Part No.	Description
JGTM4	TOUCH SCREEN TIME CLOCK

- **Touch Screen technology**
- **Operates up to 4 zones**
- **4 different time settings per day**
- **Holiday function**

Designed to be used with JGDSSB Dial Setback Room Thermostat (see page 17) and the UH3 Wiring Centre.

A mains voltage Touch Screen 4 Channel Time Clock that can be set to a 5day/2day or 7 day programme mode and has the facility to operate up to 4 different time settings per day. The 4 zones can be used to control underfloor heating, radiator heating or hot water.

A copy facility makes for easier programming. Whilst a holiday function will put the system into permanent set back mode while you are away from the property.

Note that Programmable Room Thermostats do not need the control of a separate time clock as they have their own built in time and temperature facility.

8 ZONE WIRING CENTRE



Part No.	Description
JGUH3	8 ZONE WIRING CENTRE

- **Easy to wire**
- **4 time clock connections**

Easily wired up, the wiring centre offers a simple solution for the control of Underfloor Heating, plus hot water and 1 radiator circuit, conveniently allowing all to be wired to a central base.

Of 4 Time clock connections, 2 are dedicated for setback zones and 2 are user selectable for hot water, towel rail or radiator circuits.

Neons indicate Zone, Power, Water, Pump, Boiler and Motorised Valve operation.

Dedicated connections for Boiler, UFH Pump UFH Motorised Valve, 4 Channel Time Clock, Actuators etc.

JGUH3 can also be used for the control of Energy Saver Radiator Zones. See Page 26.

PROGRAMMABLE ROOM THERMOSTAT



Part No.	Description
JGPRTE	PROGRAMMABLE ROOM THERMOSTAT

- **Individual zonal temperature control**
- **5 day/2 day or 7 day programme**
- **Multi functional**

A slimline Digital Programmable Room Thermostat to give individual time and temperature control on a 5 day/2 day or 7 day programme to allow for different time settings for every day of the week providing total flexibility. Offers the facility of up to 4 different time and temperature settings per day. The thermostats are multi-functional and self learning. This means that to avoid unnecessary use of energy, the thermostat will delay the heating start up until the last possible moment needed to achieve comfort level at the programmed time.

The thermostat features a large backlit display which makes for easy reading when in use, and has the facility to connect to a remote probe part number JGPROBE (see page 10).

A holiday function reduces the set temperature to a frost setting during a holiday period and reverts back to comfort level at the end of a predetermined period.

PROGRAMMABLE ROOM THERMOSTAT PLUS HOT WATER TIMER



Part No.	Description
JGPRTHW	PROGRAMMABLE ROOM THERMOSTAT PLUS HOT WATER CONTROL

- **Individual zonal temperature control**
- **Addition of 5 day/2 day hot water timer**

As JGPRTE but with an addition of a 5 day/2 day timer for domestic hot water. Heating and hot water can be set to give different timed control periods.

DIAL SET BACK ROOM THERMOSTAT



Part No.	Description
JGDSSB	DIAL SET BACK ROOM THERMOSTAT

Used in conjunction with a Touch Screen Time Clock JGTM4.

A modern easy to use Dial Room Thermostat with Set Back facility controlled from a centralised time clock JGTM4.

The thermostat is set manually to "Daytime" temperature. A "Set Back" mode reducing temperature by 4°C is controlled by a Central Timer Clock (Part Number JGTM4). A manual override allows for permanent "Daytime" or permanent "Set Back".

Neons indicate "Daytime" and "Set Back" mode and confirm if the room is calling for heat.

The thermostat also has the facility to be connected to a remote probe part number JGPROBE.



Wireless Control System

- Easy to install and use
- Reliable
- Slimline, attractive components
- System can accommodate Underfloor Heating Radiator Zones or a combination of both



The new Wireless Control System permits flexible location of thermostats in domestic heating installations. The programmable thermostats work in conjunction with the Wireless 8 Zone Wiring Centre, which is mains powered and is ideally suited to warm water

underfloor heating as well as radiator installations. To extend the Wireless range, wireless repeaters are available to 'boost' the signal. The system is a low cost and time-efficient alternative as no cables have to be run.

WIRELESS PROGRAMMABLE ROOM THERMOSTAT



Part No.	Description
JGWPRT	WIRELESS PROGRAMMABLE ROOM THERMOSTAT

Allows flexible location and ease of installation in domestic heating installations. The programming mode allows for 5/2 or 7 day set-ups at a 0-35°C temperature range.

With a battery operated range of up to 100m operating at a frequency of 868MHz, the wall mounted thermostats are compatible with receivers JGWWC and JGWRRC.

There are 4 heating levels and a holiday function which puts the system into a permanent set-back mode while you are away from the property. The thermostats are not compatible with other JG control ranges.

WIRELESS PROGRAMMABLE ROOM THERMOSTAT PLUS HOT WATER



Part No.	Description
JGWPRTHW	WIRELESS PROGRAMMABLE ROOM THERMOSTAT

Similar to a standard Wireless Thermostat (JGWPRT) with the addition of a 5 day/2day timer for domestic hot water. Heating and hot water can be set to provide different timed control periods. Thermostats are not compatible with other JG control ranges.

WIRELESS REPEATER



Part No.	Description
JGBOOSTER	WIRELESS REPEATER

Mains powered this optional booster/repeater is placed between a thermostat/s that are out of signal range of the main receiver or in poor reception areas, allowing extended range.

Operating at a frequency of 868MHz, the signal is 'repeated' between receivers JGWWC or JGWRRC. Recess mounted requiring 35mm back box. If needed, can also be used in multiples allowing extreme range. 230V powered and non-networkable.

WIRELESS 2 ZONE RECEIVER



Part No.	Description
JGWRRC	WIRELESS 2 ZONE RECEIVER

Mains powered and is capable of controlling 2 heating zones or 1 heating and 1 hot water zone, using JG Speedfit Wireless thermostats.

Up to 32 units can be used with the wireless stats and has an operating distance of up to 100m. Recess mounted requiring 35mm back box. 230V powered and non-networkable.

WIRELESS 8 ZONE WIRING CENTRE



Part No.	Description
JGWWC	WIRELESS 8 ZONE WIRING CENTRE

Mains powered and ideally suited to warm water underfloor heating as well as radiator systems or a combination of both, using JG Speedfit Wireless Thermostats.

Operating at a frequency of 868MHz, central wiring allows for up to 8 zone actuators with an output for domestic hot water. Internal software can distinguish between hot water, underfloor heating, and radiator signals. 230V powered and non-networkable.

Optional aerial is available to extend range if required (JGAERIAL)



EXTERNAL AERIAL



Part No.	Description
JGAERIAL	EXTERNAL AERIAL FOR USE WITH 8 ZONE WIRELESS CENTRE JGWWC

System Components

NEW

MANIFOLDS - STAINLESS STEEL

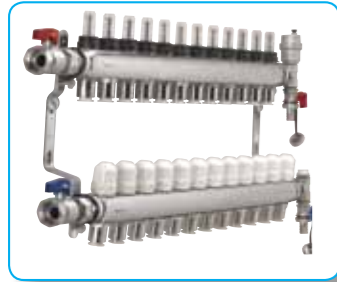

Part No.	Description
JGUFHMAN4/2	4 ZONE MANIFOLD
JGUFHMAN6/2	6 ZONE MANIFOLD
JGUFHMAN8/2	8 ZONE MANIFOLD
JGUFHMAN10/2	10 ZONE MANIFOLD
JGUFHMAN12/2	12 ZONE MANIFOLD

JG Speedfit Manifolds are manufactured from stainless steel to the highest standards.

A unique feature is that connections to the heating pipes are Speedfit Push-fit, offering much reduced installation time. All manifolds are pre-fitted with brackets, vibration isolation mounts, and an automatic air vent. Flow rate indicators include the means to adjust flow rate and isolate circuit. Can be assembled to suit left or right hand supply depending upon project type.

MANIFOLDS - BRASS

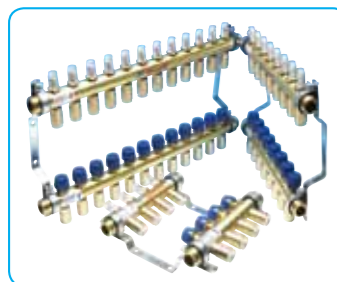

Part No.	Description
JGUFHMAN4	4 ZONE MANIFOLD
JGUFHMAN6	6 ZONE MANIFOLD
JGUFHMAN8	8 ZONE MANIFOLD
JGUFHMAN10	10 ZONE MANIFOLD
JGUFHMAN12	12 ZONE MANIFOLD

NEW

MANIFOLD EXTENSION KIT - NICKEL PLATED

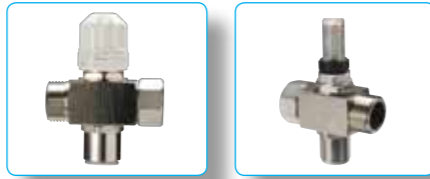

Part No.	Description
JGUFHMANEXT/2	MANIFOLD EXTENSION KIT Stainless Steel and allows a manifold to be extended by one or more zones.

MANIFOLD EXTENSION KIT - BRASS

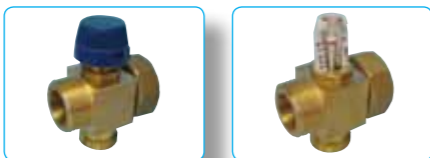

Part No.	Description
JGUFHMANEXT	MANIFOLD EXTENSION KIT

NEW

CONTROL PACK - NICKEL PLATED



Part No.	Description
JGCONTROL/2	CONTROL PACK

A compact, modular control pack for underfloor heating systems up to 14kW. Designed to be lightweight in order to connect directly to Speedfit manifolds without the need for extra brackets or support. The nickel plated material matches stainless JG Speedfit Manifold.

Pack consists of a mixing valve, circulating pump, return elbow, manifold adaptor and all necessary seals.

CONTROL PACK - BRASS



Part No.	Description
JGCONTROL	CONTROL PACK

NEW

MANIFOLD ELBOW CONNECTOR - NICKEL PLATED



Part No.	Description
JGUFHMANELB/2	MANIFOLD ELBOW CONNECTORS

Nickel Plated and enables a pump pack and manifold to be installed at 90°C to each other.

MANIFOLD ELBOW CONNECTOR - BRASS



Part No.	Description
JGUFHMANELB	MANIFOLD ELBOW CONNECTORS

Fixing Systems

PIPE STAPLES



Part No.	Description
JGUFHGUN	STAPLE GUN
JGUFHSTAPLE	PIPE STAPLES

Pipe Staples are barbed to ensure a secure fixing to the insulation. Easy fixing is carried out by using a Staple Gun, securing the pipe to the insulation with an easy repeatable action. 1 box per 20m².

MOUNTING RAIL



Part No.	Description
JGUFHRAIL	2 METRE LONG
JGUFHPIN	RAIL PINS FOR ABOVE

Mounting Rails offer a quick installation of 15mm pipe, supplied 2 metres long, the rails are pre scored every 100mm for easy cutting. The rail can be secured using red Rail Pins. 1 pack per 20m²

Fixing Systems cont.

FLOOR CLIP



Part No.	Description
JGUFHCLIP	FLOOR CLIP
JGUFHTOOL	FOR EASY FIXING OF FLOOR CLIPS

Floor Clips screw easily into the insulation to retain 15mm pipe, they are best installed using a Fixing Tool.

CONDUIT ELBOW



Part No.	Description
JGUFHCONELB	CONDUIT ELBOW

EDGE STRIP



Part No.	Description
JGUFHEDGE	25 METRE ROLL

Used with solid (screeded) floors, Edge Strip is used around the edge of a room to provide an expansion gap for the solid floor as it heats up and cools down.

NEW

OVERLAY BOARD - OVER FLOOR

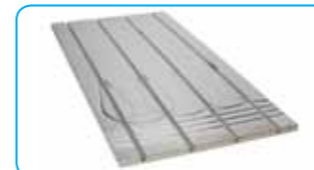

Part No.	Description	Size
JGUFHBOARD1	OVERLAY BOARD	1250MM X 600MM

Grooved foil faced insulation panel for installing 15mm tubing over existing floor structures (between battens) or under floor (between existing joints).

Heat output approx 50 - 60w/m²
Recommended flow temperature 50 - 60°C
Maximum circuit length 100m
Typical cover per loop 13 - 15m²
Individual panel size 600 x 1250 x 25(mm)
Pipe spacing 150mm
Approx 7.5m² per box.

NEW

OVERLAY BOARD - JOISTS AND BATTENED FLOORS

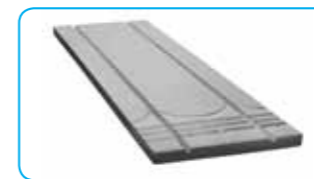

Part No.	Description	Size
JGUFHBOARD2	OVERLAY BOARD	1250MM X 350MM

Low profile system for new build or renovation projects. Grooved foil faced insulation panel for installing 15mm tubing over existing floor structures to facilitate the use of Underfloor Heating.

Heat output approx 50 - 60w/m²
Recommended flow temperature 50 - 60°C
Maximum circuit length 100m
Typical cover per loop 15 - 20m²
Individual panel size 350 x 1200 x 50(mm)
Approx 4m² per box.

FLOOR PANELS

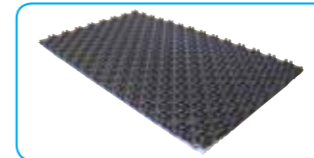

Part No.	Description	Size
JGUFHTILE	Floor Tile	1400MM X 800MM

Supplied in packs of 12, Speedfit Floor Tiles have an 11mm layer of insulation for support and additional thermal insulation.

SPREADER PLATES

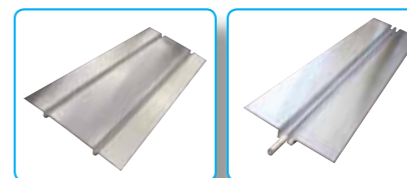

Part No.	Description
JGUFHSP400	390MM X 1000MM
JGUFHSP250	390MM X 250MM
JGUFHSP165	165MM X 1000MM

Spreader Plates 390 x 1,000mm and 390 x 250mm are laid across traditional joists and fixed in place using a hand stapler.

Spreader plates 165mm x 1000mm are designed to be used with composite joists and are fixed from below.

Speedfit Pipe is fixed in the grooves of the plates, insulation is placed in the void below the plates to minimise downward heatloss.

Above: approx 2 plates per 1m²
Below: approx 4 plates per 1m²

ACTUATOR VALVE



Part No.	Description
JGUFHA(240 v)/2	240 v CIRCUIT ACTUATOR VALVE

Controlled by a thermostat or programmer, Actuator Valves operate to open or close the flow of water to an individual circuit on the manifold.

Pipe

SPEEDPEX BARRIER PIPE



Part No.	Description	Size
15BPEX-50C	BARRIER PIPE	15MM X 50M
15BPEX-100C	BARRIER PIPE	15MM X 100M
15BPEX-120C	BARRIER PIPE	15MM X 120M
15BPEX-150C	BARRIER PIPE	15MM X 150M

POLYBUTYLENE BARRIER PIPE

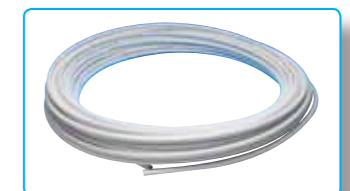

Part No.	Description	Size
15BPB-50C	BARRIER PIPE	15MM X 50M
15BPB-100C	BARRIER PIPE	15MM X 100M
15BPB-120C	BARRIER PIPE	15MM X 120M
15BPB-150C	BARRIER PIPE	15MM X 150M

Offered in PEX or Polybutylene, Speedfit Pipe has an inner barrier to prevent the ingress of atmosphere, it is manufactured and Kitemarked to British Standard BS7291 : Parts 1,2 & 3: Class S.

It is lightweight and flexible making it especially suitable for underfloor heating installations.

For screed systems, the pipe is attached directly to insulation with staples, floor clips or mounting rails.

Spreader Plates are available for timber flooring using either traditional joists or engineered timber joists.

Underfloor Heating for Conservatories and Extensions

SINGLE ROOM CONTROL UNIT

Part No.	Description
JGROOMPACK	SINGLE ROOM CONTROL UNIT

The new Speedfit Underfloor Heating Control Unit is the ideal way to provide heating to a conservatory or room extension, up to 30m².

The unit is pre-assembled and pre-wired to allow for a fast and simple installation. It can be plugged into any convenient electrical socket or spur.

The control unit has integral ball valves to allow for isolation from the primary heating system, an adjustable blending valve and a six metre head circulation pump. An anti-vibration mounting bracket ensures silent operation.

Speedfit push in connections make for a fast connection to pipework.

Speedfit recommend connection to the main central heating flow and return distribution system, using a dedicated motorised valve. It is also possible to connect to the nearest radiator supply pipe. If connected to an existing radiator circuit, the pump will be unable to operate independently, only able to obtain hot water when the radiator system is on.

A full and detailed installation guide is provided with each unit.

The Speedfit Underfloor Heating Control Unit is suitable for use when:

- The boiler serving the existing heating system has the capacity to take the extra output from 2KW to 3KW.
- The maximum area to be heated is 30 sq metres.

The Control Unit is designed to be used with Speedfit Barrier Pipe. The amount of pipe needed is determined not only by the size and shape of the room but by the resistance of the floor finish to heat transfer.

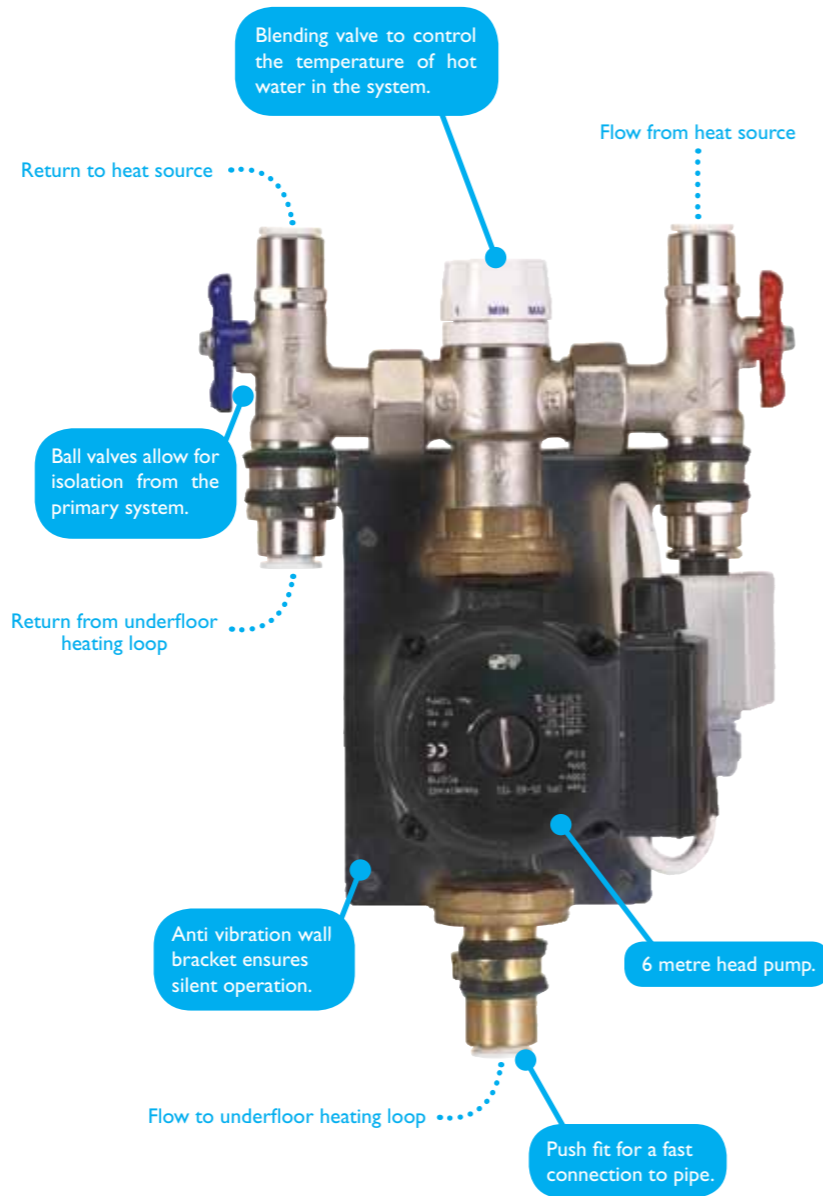

OPERATING PRINCIPLES

The Speedfit Control Unit will operate automatically when the central heating circuit is on and the water temperature flowing through it has reached 40°C. The pump will continue to run until the temperature of water flowing through it from the heating circuit falls to approximately 30°C.

The blending valve will maintain the temperature of the underfloor heating circuit by blending flow from the boiler with the cooler return flow from the underfloor heating circuit.

Underfloor Heating Packs

Speedfit Underfloor Heating Packs consist of:

A Control Unit which is pre assembled and pre wired, has integral ballvalves to allow for isolation from the primary system, an adjustable blending valve to control the temperature of the water and a high quality 6 metre head circulating pump. An anti-vibration mounting bracket ensures silent operation.

Programmable Room Thermostat to give individual time and temperature, with a simple menu for easy adjustment. Control can be either 5 day/2 day or 7 day with up to 4 different time and temperature settings per day.

Speedfit Barrier Pipe that is lightweight and flexible with an inner barrier to prevent the ingress of air. Manufactured and Kitemarked to BS7291 Class S.



INSTALLATION REQUIREMENTS

The Heating Pack is designed to be used in solid floor applications.

The floor insulation material will normally need to be 50mm, the pipe fixed to the insulation using floor clips. A sand and cement screed of 65mm to 75mm laid on top.

In areas of high heatloss such as conservatories, additional heating may be needed to achieve comfort levels.

A detailed Installation Guide is provided with each unit.

Please note Single Room Pack installations are not included as part of our Design and Technical Support Service.

For floor areas greater than 30 sq m, Speedfit offer an Underfloor Heating System that can cater for any size of project. Please contact the Technical Help Desk Tel 01895 425333.



Part No.
JGUFHPACK20

THE 20SQM PACK CONTAINS :-

- | | |
|-----|-----------------------------------|
| 1 | Control Unit |
| 1 | Programmable Room Thermostat |
| 1 | 15mm x 150m Coils of Barrier Pipe |
| 200 | Pipe Clips |
| 2 | Pipe Inserts |



Part No.
JGUFHPACK30

THE 30SQM PACK CONTAINS :-

- | | |
|-----|-----------------------------------|
| 1 | Control Unit |
| 1 | Programmable Room Thermostat |
| 2 | 15mm x 100m Coils of Barrier Pipe |
| 300 | Pipe Clips |
| 8 | Pipe Inserts |
| 2 | 15mm Speedfit Equal Tees |
| 2 | 15mm Speedfit Stem Elbows |

Installation Advice

It is important to carefully consider the ideal installation method for your underfloor heating project. The pipe fixing technology offered by JG Speedfit Underfloor Heating will ensure that the right materials and methods are used for the job's requirements. Installations normally fall within three categories:



SOLID / SCREEDED FLOORS

The screed is an important and integral part of the UFH system, transferring energy from the pipes to the area to be heated. The response of this 'thermal mass' will depend on its depth and make up. The usual depth of screed is 65-75mm thick but it is possible depths can be reduced to assist in improving performance. It is suitable for us in either new build or existing properties.



TIMBER / FLOATING FLOORS

Often found in the upper floors of a property, a system is required where a solid floor installation is not suitable due to structural reasons.



OVER EXISTING FLOORS

An Underfloor Heating system that is installed over existing flooring which is suitable for both new build and renovation projects. This means that current flooring does not require extensive alteration.

PIPE LAYOUT IN SOLID FLOOR INSTALLATIONS

The shape of the room and the position of the outside walls and windows will determine the pattern of the pipe layout. The counterflow pattern is recommended although other options are shown opposite.

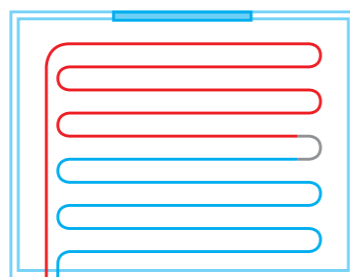

Single Serpentine

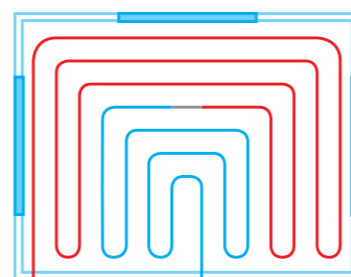

Triple Serpentine

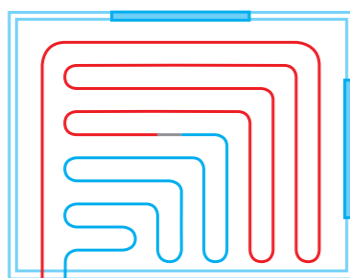

Double Serpentine

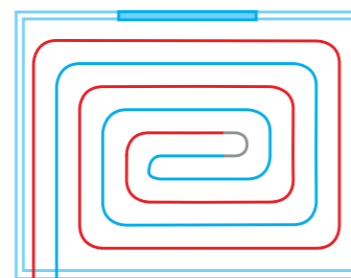

Counterflow

Step by step Installation Guides Installing the Manifold

The installation of the manifold is an integral stage of a heating system. The JG Speedfit manifold kits are for use on underfloor heating or radiator systems. The manifold consists of two rails, one for the flow and one for the return, complete with ball valves and drain / filling valves. JG manifolds are complete with pre-fitted brackets and vibration isolation mounts.



STEP 1. Fix the pre-assembled manifold to the wall, allowing enough height to accommodate the insulation and screed depth and also the pipe work and conduit elbows.



STEP 2. Using the supplied washer fit the JG control pack. Isolation valves fitted to the inlet side of this unit will be useful in the event of needing to change a pump or blending unit.



STEP 3. Connect the pipework to the manifold following the guidelines for fitting JG pipe and fitting. It is best to start from one end of the manifold and work to the other. The use of JG conduit elbows will make the process easier and neater and enable the conduit to be inserted into the socket end.



STEP 4. Run the pipework from the manifold to the room that is to be heated. Ensure that if the pipework is passing through other rooms that conduit is used to prevent the pipework influencing the heat in those rooms. Ensure the pipework is at least 75mm from the perimeter wall.



STEP 5. The flow meters at the top of the manifold give a visual indication of the amount of water flowing through each circuit. The amount of flow will depend on the length of circuit and the temperature drop required. Generally the shorter the circuit the more restriction will be needed; this is called balancing the system. This is achieved by lifting the locking ring at the base of the flow gauge and twisting the glass shroud.



STEP 6. The designed temperature through the circuits is controlled by turning the blending valve knob to the desired temperature.

THINGS TO REMEMBER

- Insulation depth as required by design or building regulations and to ensure that any downward heat loss does not exceed 10 watts per m² in accordance with BS EN 1264.
- Decorator caps can be used for manual isolation of a circuit and will usually be replaced by Electro Mechanic Actuators for fully automatic control.

Installing the JG Mounting Rail

Using the screed as a heat diffuser, Speedfit Pipe is secured to 'Clip Rails' on top of rigid insulation which is placed over the concrete sub-floor. A variety of screeds can be used and are typically 65-75mm thick for sand-cement types or 40-50mm for liquid pumped screeds. The system provides ready made pipe spacing, can be fixed to insulation which is too thin for staples, and is especially suitable for large regular shaped areas. Floor coverings can be laid when the screed is fully cured.



STEP 1. Prepare the floor and insulation should be fitted to a flat sub-base. The joints should be taped and membrane placed over the insulation.



STEP 2. An expansion strip is required around the perimeter of the room to accommodate the expansion which will occur within the screed as a result of heating up. This should be fitted around the perimeter of the room and taped to the membrane.

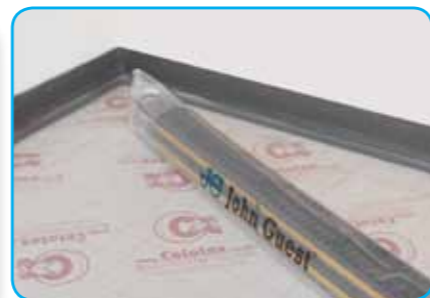

STEP 3. After establishing the area to be covered by the circuit, connect to the manifold and start the circuit. If the circuit has to pass through other heated zones before reaching the zone it is intended to heat, conduit may be required.



STEP 4. The mounting rail has double sided tape, this may need to be supplemented with the use of JGUFHPIN depending on the adhesions of the installation.



STEP 5. The mounting rail is placed at about 750/800mm apart ensuring the slots are aligned neatly.



STEP 6. A serpentine pattern is usually the most convenient to use with the mounting rail system. Ensure to allow enough space at the end of the circuits for the flow and return from the manifolds.

THINGS TO REMEMBER

- 1.5 to 2 linear metres of mounting rail per sq/m of floor area. 1 pack per 20sq/m
- Maximum circuit length 100m of 15mm pipe
- Maximum coverage Approx. 100m centres 11 sq/m 200mm centres 20sq/m 300mm centres 30sq/m
- Maximum heat output for 200mm centres = 100Wsq/m
- Recommended design flow temperature 50°C.
- Insulation depth as required by design or building regulations and to ensure that any downward heat loss does not exceed 10 watts per m² in accordance with BSEN1264.

Installing of UFH Staple System

Using the screed as a heat diffuser, JG Speedfit pipe is secured with staples to rigid insulation placed over the concrete sub-floor. A variety of screeds can be used and are typically 65-75mm thick for sand-cement types or 40-50mm for liquid pumped screeds. The system is quick to install, cost effective, and can be easily adaptable to irregular room shapes. Floor coverings can be laid when the screed is fully cured.

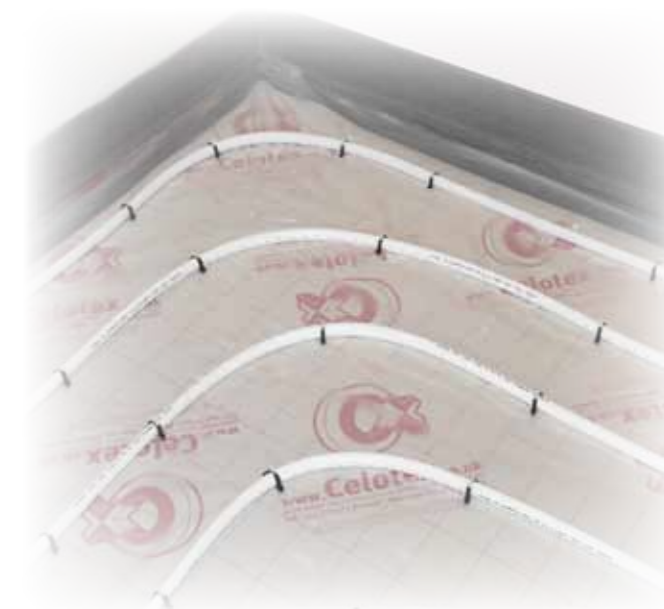

STEP 1. To prepare the floor, insulation should be fitted to a flat sub-base. The joints should also be taped and a membrane placed over the insulation.



STEP 2. An expansion strip is required around the perimeter of the room to accommodate the expansion which will occur within the screed as a result of heating up. This should be fitted around the perimeter of the room and taped to the membrane.



STEP 3. After establishing the area to be covered by the pipe circuit, connect to the manifold and start the circuit. If the circuit has to pass through other heated zones before reaching the zone it is intended to heat, conduit may be required.



STEP 4. Using the staple gun, fix the pipework to the installation in the desired pattern (see images on patterns of pipework). Starting the first circuit 75mm from the perimeter and staples should be approximately 500mm apart. More staples maybe needed on bends.



STEP 5. When using the pipe, unroll it from the outside of the coil and do not try to uncoil it from the centre, this will make the process easier. Keeping the first run of pipe around the perimeter straight and using a gauge to keep the designed pipe centres even will also help the installation process.



STEP 6. Once the pipe circuit has been installed and pressure tested, the system should remain under pressure (6 bar) in order to help prevent the risk of any damage to the pipe while the screed is being applied. When applying the screed, care should be taken to ensure the screed is tightly compacted around the pipe ensuring no voids are present.

THINGS TO REMEMBER

- Insulation depth as required by design or building regulations and to ensure that any downward heat loss does not exceed 10 watts per m² in accordance with BSEN1264.
- The overall quality and thickness of a sand and cement screed should meet the requirements of BS8204-1.

Installing of JG Floor Panel System

Speedfit Floor Panels make a simple grid to ensure quick and easy pipe laying and also provide a precise guide for the pipe, ensuring that minimum pipe bending radius is achieved. Suitable for use with; cement screed (4:1 mix), pumped screed systems (anhydrite, etc.), fine or heavy concrete or polymer modified screeds.



STEP 1. Edge insulation should be installed around the perimeter of the room to accommodate expansion that will occur when the screed is heated up. It is good practice to seal the gap between the potential space between the expansion and the floor panel.



STEP 2. Floor panels should be fitted to a suitable flat sub base. Extra insulation maybe required to match design or building regulations and to ensure that any downward heat loss does not exceed 10 Watts m2 in accordance with BS EN 1264.



STEP 3. The "egg box" sections of the panel clip firmly together to make a continuous seal. Floor panels should not be used at the base of a manifold as pipes need to be closer together than the floor panels will allow. Pipes around this area should be secured using pipe staples.



STEP 4. When a pumped (liquid) screed is to be used it is essential that all of the panel joints are made correctly and that no panels are allowed to simply 'butt-up' as this may allow the screed to flow below the panels causing them to rise up.



STEP 5. Starting from a manifold, after establishing the area to be covered, unroll the pipe and push firmly into the gap between the egg box sections. Cover the designed area in the appropriate pattern and return the pipework to the manifold.



STEP 6. Once the pipe circuits have been installed and pressure tested, the system should remain under pressure (6 bar) in order to prevent the risk of any damage being caused to the pipe while the screed is being applied. When applying the screed cover, care should be taken to ensure that the screed is tightly compacted.

THINGS TO REMEMBER

- BS EN 1264-4 recommends that an expansion joint is constructed in stone and ceramic finished screeds for every 40m² of floor area at a maximum length of 8m and an aspect ration of 2:1. An expansion joint is also required in long narrow areas such corridors etc.
- Insulation depth as required by design or building regulations and to ensure that any downward heat loss does not exceed 10 watts per m² in accordance with BSEN1264.

Installing of UFH Overlay System

The JG UFH Overlay is a low profile System for new build or renovation projects.

JG Overlay is a lightweight insulated panel with high compressive strength intended for use on lightweight floor coverings, e.g. laminate, engineered wood and carpet. Due to its ease of handling and cutting it is also suitable for larger areas and multiple room installations.

The installation uses 15mm pipe and 150mm centres for a highly responsive system.

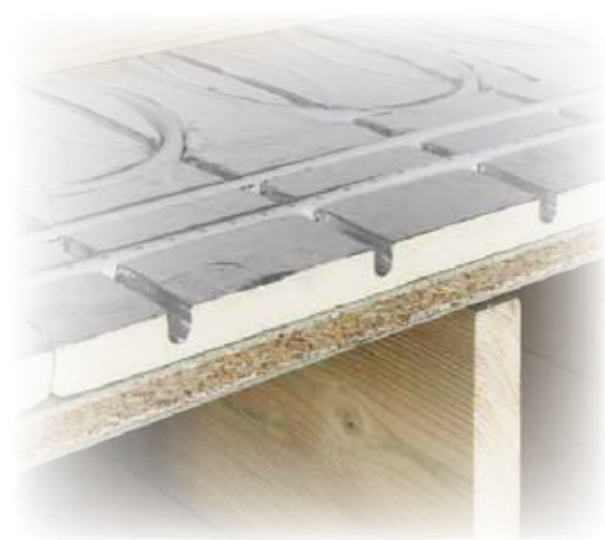

STEP 1. Planning the installation will save time later and make installation easier. The main consideration is the amount of runs and the route those pipes will take from the manifold. There are a number of parallel grooves at either end of the boards. If more transit grooves are needed then the grooves at the opposite ends can be cut off and used. Where possible route pipes through rather than around walls and doorways to cut down on pipework congestion. When lining up panels use a short length of pipe placed in the grooves to align them together.



STEP 2. Plates need to be supported so that they sit level and make a good contact with the floor placed on them from above. Maintaining this contact is essential in producing good heat transfer performance.



STEP 3. After placing the boards and ensuring they are flat and level and the joints are butted up firmly, tape the joints using JGTAPE.



STEP 4. Start laying the pipework by pressing it firmly into the grooves. Where the pipework is connected to the manifold there will be a need to use plain insulation and pipe staples to accommodate the closer pipe centres.



STEP 5. Where the pipe changes direction cut the foil in the return loops using a craft knife to prevent damage to the board. This will ensure a tight fit for the pipework.



STEP 6. After installing the pipework JGTAPE can be placed over the end loops to prevent the pipework from becoming dislodged during the installation of the finished floor.

DATA - 25mm OVERLAY BOARD

Dimensions	- 1250 x 600 x 25 mm
Materials	- Extruded Polystyrene-XPS2 (BS EN 13164)
Compressive Strength	- 250 (kPa) @ 10% compression
Conductivity	- 0.029 (W/mk)
Heat Output	- Approx 50 - 60w/m ²
Recommended Flow Temperature	- 50 - 60°C
Pipe Centres	- 150mm
Maximum Circuit Length	- 100m
Typical Coverage per Loop	- 13 - 15m ²
Applications	- New Build or renovation, single or multiple rooms

Floor Coverings	Tiles/slate/ceramic etc. - use with Knauff Brio Board or suitable plyboard.
Carpet/vinyl	- use with suitable plywood covering.
Laminate floors	- use directly over insulation as floating floor.
Natural wood	- fix to battens between panels.

Installing JG Overlay - Joists and Battened Floors

A grooved, foil faced insulation panel for installing 15mm Speedfit pipe over existing floor structures (between battens) or under the floor (between existing joists). The system is a suitable choice for both new build and renovation projects.

Similar to other JG Speedfit Underfloor Heating systems, a variety of floor coverings can be used. The JG panels will prove an excellent installation method for optimising heat efficiency and lowering energy consumption.



STEP 1. JG 'Underboard' is intended to be used below flooring and supported firmly in contact with the underside of the flooring. It is ideally suited to refurbishment projects. As with all UFH systems additional insulation may be required to meet building requirements.

STEP 2. Some time spent planning the installation will save time later and make installation easier. The main consideration is the amount of runs and the route these pipes will take from the manifold.

STEP 3. Battens should be fixed along the length of the joist, 50mm down from the top of the joists in order to support the panels along its length. Good contact between the surface of the panel and the bottom of the flooring is essential in maximising the performance of this system.

STEP 4. Grooves spaced at 200mm from centre of pipe or 67.5mm from edge of grooves, the boards can be sized to accommodate most joist centres. If the panel is too wide, trim the material evenly from both sides to ensure a snug fit.

STEP 5. Allow 300mm at the ends of the panels for the pipe return bends.

STEP 6. Pipework can enter the panel system at either end or even in the centre, pipework can be cabled through joists or via grooves at the top of the joists. Consult building regulations to ensure compliance.

DATA - 25mm OVERLAY BOARD

Dimensions	- 1200 x 350 x 50 mm
Materials	- Expanded Polystyrene BS EN 13163
Compressive Strength	- 100 (kPa) @ 10% compression
Conductivity	- 0.036 (W/mk)
Heat Output	- Approx 50 - 60w/m ²
Recommended Flow Temperature	- 50 - 60°C
Pipe Centres	- 200mm
Maximum Circuit Length	- 100m
Typical Coverage per Loop	- 15 - 20m ²
Applications	- New Build or renovation, single or multiple rooms

Floor Coverings	- Tiles/slate/ceramic etc. Carpet/Vinyl Laminate floors Natural wood
-----------------	---

Installing JG UFH Plate System - From Above

JG Speedfit's plate system is designed for use in timber suspended or battened floors, the floor system uses aluminium single or double spreader plates to transmit the heat evenly across the finished floor surface.

They can be used as illustrated, below a floor supported on insulation. Alternatively, where there will be a secondary layer of floor placed above a sheet sub floor the plates can be sandwiched between the floor layers supported on battens. With a twin layer floor this second method is recommended as it removes a layer of resistance to heat transfer.

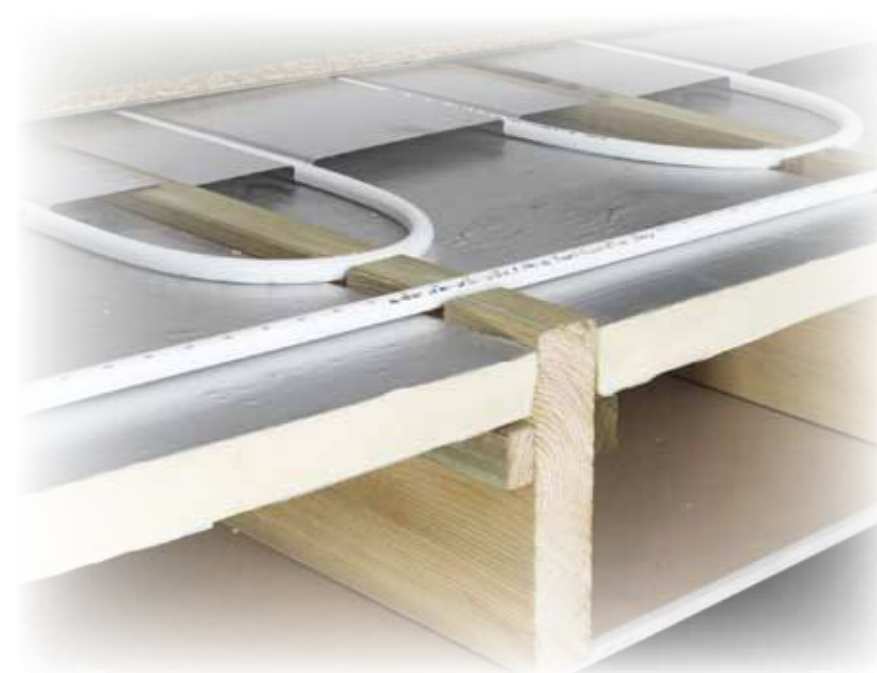

STEP 1. Plates need to be supported so that they sit level and make a good contact with the floor placed on them from above. Maintaining this contact is essential in producing good heat transfer performance.

STEP 2. Some time spent planning the installation will save time later and make installation easier. The main consideration is the amount of runs and the route those pipes will take from the manifold.

STEP 3. Battens should be fixed along the length of the joist, 15mm plus the depth of insulation board being used down from the top of the joists in order to support the insulation along its length. This will allow a 15mm gap between the surface of the insulation and the top of the joist.

STEP 4. Fix the plates to the top of the joists ensuring the fixing will not protrude and prevent the floor from having a good contact with the floor. 18mm staples fixed using an air stapler is the preferred method. Allow 300mm for pipe end returns and a 15mm gap between plates. Use a short length of pipe pressed into the grooves to line up the plates before fixing.

STEP 5. Run the pipework to the designed or desired pattern being careful to ensure the plates remain flush with the top of the joists. The pipework can enter the plate system at either end or in the centre, pipework can be cabled through joists or via grooves at the top of the joists. Consult building regulations to ensure compliance.

STEP 6. Before fixing the floor to the joists it is recommended that a thin sheet of plastic is placed over the plates. This will act as a slip membrane to cut down expansion noises as the plates heat up and rub against the bottom of the finished floor.

KEY DATA

Approx. Coverage Double Plates	- 2 Plates per 1m ² 1 box of 10 = 5m ²
Approx. Coverage Single Plates	-
Recommended Design Temperature 60°C	- Maximum Heat Output Approx. 70W/m

Energy Saver System

THE SYSTEM

Using standard manifold connections it is possible to develop a radiator valve capable of being controlled by a 240v Actuator head instead of a wax head, it will be possible to control each radiator, or groups of radiators, by time and temperature, instead of just time.

It will use conventional heating systems and be very easy to install, requiring no extra work from the plumber.

Control wires need to be routed to the radiators, but this will be an easy task enabling this system to be installed in new or existing applications worldwide.

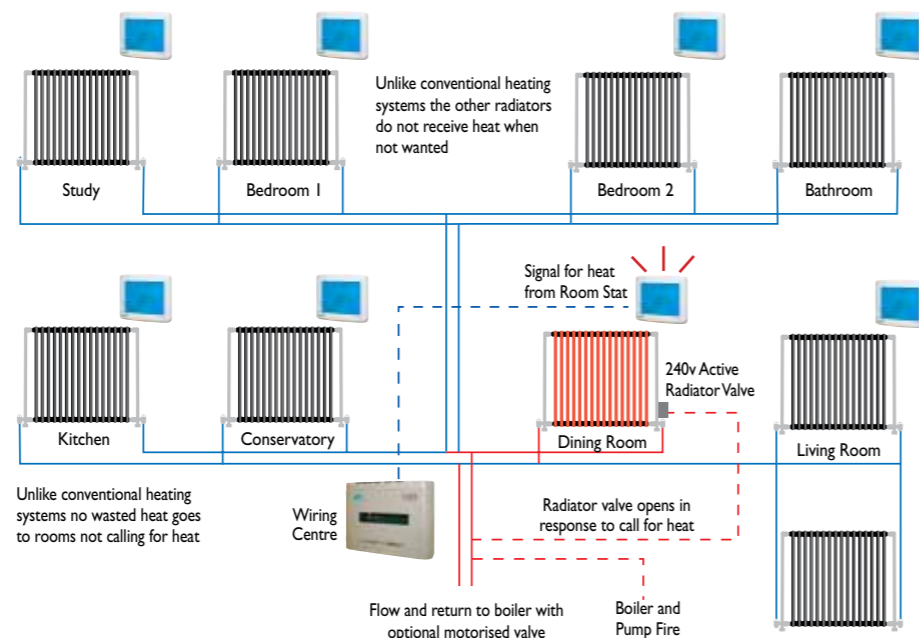

"The ability to properly control individual rooms according to their use appealed to us in a number of ways. It is energy efficient, user friendly and is the way heating systems of the future need to be installed. We were so convinced we have installed it on a prestigious development in Boverton."

Steven Vanprag Summerhouse Point Development Ltd

"I am installing the Manifold system in my new house. I like the idea of being able to turn off areas of my house that I am not using. Only paying for the heat in the rooms that I want and when I want, it seems obvious when I think about it."

Royston O'Riley Home owner

FITTINGS AND PIPE

Speedfit offer a full range of Push-fit fittings and pipe to cover any plumbing or heating situation.

Performance specifications are well within those required for most domestic plumbing and heating systems including mains feed cold water systems and vented and unvented hot water systems.

The system is approved by the British Board of Agrément and the Water Regulations Advisory Scheme. Speedfit 'PEM', 'PSE' and 'SFM' Fittings and Speedfit Barrier Pipe are Kitemarked to BS7291 Parts 1, 2, & 3 Class S Licence No KM39767.



Electrical Controls for use with Energy Saver System

Choose from a range of:

Low Voltage Network Control Products

TOUCHPAD, TOUCH SCREEN THERMOSTAT, PROGRAMMABLE THERMOSTATS AND WIRING CENTRE



Mains Voltage Electrical Controls

WIRING CENTRE, TIME CLOCK, DIAL THERMOSTAT PROGRAMMABLE ROOM THERMOSTAT AND ACTUATOR VALVE



Manifolds



Pipe

SPEEDPEX AND POLYBUTYLENE BARRIER PIPE



Technical Checklist - Underfloor Heating

- **Applications.** Underfloor Heating Installations in solid or timber floors.
- **Pipes.** 15mm JG Speedfit Barrier Pipe to BS 7291, Parts 1, 2 and 3 Class S.
- **DO NOT USE Speedfit UFH Products for Gas, fuel oil or compressed air applications.**
- **Floor Insulation.** Should be a suitable material and thickness to comply with current regulations.
- **Minimum Bending Radii.** For Speedfit B-PEX Pipe is 175mm.
- **Expansion (PEX - Pipe).** 1% on length between 20°C and 82°C.
- **Cleaners, Inhibitors and Descalants.** For advice on the replenishment of additives such as corrosion inhibitors, the following manufacturers should be contacted Fernox Manufacturing Limited on 01799 550811 or Sentinel, BetzDearborn Limited on 0151420 9595.
- **Paint and Chemicals.** Only use water or oil based paint. DO NOT ALLOW CONTACT WITH cellulose based paints, paint thinners or strippers, solder flux or acid based descalants or aggressive household cleaning products.
- **Exposure to sunlight.** Speedfit products, when used indoors, are not affected by sunlight. When used outdoors protect from ultra violet light by lagging or painting.
- **Pipe Inserts.** Must be used on all installations when using plastic pipe and should be fully inserted.
- **Electrical Components.** Electrical products in the Speedfit Underfloor Heating System are designed only to be used in U.K. Electrical Supply situations.
- **Electrical Continuity.** If Speedfit is used in an existing metal system which may have been used for earthing, electrical continuity should be reinstated.
- **Collet Clips.** White and Grey collet clips are used with standard fittings to prevent accidental pipe disconnection. Red or blue clips provide colour coding of pipe. Red and blue clips should not be used to prevent accidental release of pipe.
- **Pre-Screen System Testing.** To ensure the pipework has been installed correctly and prior to the screed being laid, it is essential that the system is checked and hydraulically wet tested. Testing should be carried out at 2 bar for 10 minutes and 10 bar for 10 minutes. This testing, combined with other relevant checks, should reveal installation problems and is regarded as good plumbing practice.
- **Pressurisation During Screed Laying & Curing.** In accordance with BS1264-4, the system should be left under pressure at a minimum of 6 bar for the duration of the laying and curing of the screed.
- **Under NO circumstances should the UFH System be used to quicken the screed drying process.**
- **System Flushing.** As is usual practice for any plumbing installation, flushing of the system prior to the use of JG Speedfit is recommended to remove any contaminants/chemical residue from elsewhere in the system.
- **Vermin.** Speedfit products should not be used in vermin infested areas.
- **Frost Protection.** During the installation process it is important that pipe containing water be protected from frost.

John Guest Speedfit Limited

Horton Road, West Drayton, Middlesex UB7 8JL, England.

Tel: 01895 449233 Fax: 01895 420321
www.speedfitUFH.co.uk www.speedfit.co.uk
Technical Help Desk: 01895 425333



AVAILABLE FROM:

The company has a policy of continuous research and development and reserves the right to amend without notice the specification and design of all products illustrated in this catalogue. John Guest Speedfit reserve the right to change the colour and shape of products. Photographs are for illustration purposes only. Subject to our Terms and Conditions of Sale available on request.

JG, John Guest® and Speedfit® are registered trademarks of John Guest International Limited © Copyright 2011.

Z2105/290/03/11