



Salamander Pumps

Quality | Technology | Service | Value

Pump installation and warranty guide for pumps

RGP, RHP, RSP and ESP



Making **Water** perform

ISSUE 14 September 2011

6479

Salamander Pumps



Salamander Pumped Shower Systems Limited

Unit 2c Collina Avenue, Sunderland, SR5 3XE

Tel: 0191 516 2002

Fax: 0191 548 4445

Email: service@salamanderpumps.co.uk



PERF

Warranty card

Please use block capitals:

Date of purchase	____/____/____
------------------	----------------

Pump serial number	_____
--------------------	-------

Model	_____
-------	-------

1 User name

Address _____

Postcode _____ Tel No. _____

Email address _____

2 Installer name

Address _____

Postcode _____ Tel No. _____

Email address _____

3 Supplier from whom pump was purchased

Name _____

Address _____ Postcode _____

4 What is the approximate cold water storage capacity (in gallons)?

5 Where is the pump situated? How far is it from the hot water cylinder?

6 Does the pump have dedicated hot and cold water feeds (not shared with other services) YES NO

7 Does the hot water cylinder have a flange fitted? If yes, what type?
YES NO Type _____

8 Does the hot water cylinder have a temperature control fitted? If yes, what temperature is the cylinder stat set to?
YES NO Temperature _____

11 Why did you choose a Salamander pump?

Comments _____

I am interested in an extended warranty. Please tick box
Please send details of the Extended Warranty Scheme and application form.

Pump installation and warranty guide for pumps RGP, RHP, RSP and ESP

! Important – read this first!

- **Correct installation is the guarantee of safety and a trouble free system. It is therefore important to read these instructions thoroughly and ensure you comply with them. Incorrect fitting can invalidate the warranty.**

Pages 10 to 11 of this manual provide clarification of some of the more unusual installation requirements. If your installation is complicated or you have any questions please CONSULT THE PUMPWISE HELPLINE IMMEDIATELY. If you are calling from site and need urgent technical guidance, please let us know – and we will prioritise your call.

We encourage installers to consult the Salamander helpline, where our engineers can give you first-rate advice regarding installation. Consulting the helpline will entitle your customer to an additional year's warranty FREE (UK only) – all you have to do is call us, implement our engineers recommendation for your installation situation, then ask your customer to register.

When the job is finished – tear off the final page of this instruction manual and hand it to the householder. This page explains the warranty provisions and provides a pre-paid warranty card.

Don't forget that if you have called our helpline you should also complete the comments section of the card to say how you rate the service you received.

Please leave this installation guide with the customer for reference to maintenance and safety information.

*Thank you for choosing
Salamander Pumps*

Contents

Pre-installation checklist	2
Typical installations	
RSP and RHP pumps	6
ESP CPV pumps	
System operation and L.E.D. indication	7
Typical installations	
ESP CPV pumps	10
Commissioning	12
Helpful PumpWise guidelines	13
Cold water supplies and storage	
Helpful PumpWise guidelines	15
Water starvation protection, pipework arrangements and stored hot water	
General specifications	19
Trouble shooting	20
PumpWise and warranty	22
To the installer	23

Pre-installation checklist

Our pre-installation guidelines are detailed on the following pages, but some of the key “do’s and don’ts” are highlighted below:

Do’s

- Locate the pump next to the hot water cylinder OR no further than 4m away in 22mm pipe work
- Allow 100mm on all sides for ventilation
- Ensure pump is protected from frost
- If servicing two or more bathrooms, cold water supply to the cylinder must be in 28mm pipe work
- Ensure adequate cold water storage (50 gallons/bathroom, 80 gallons for one bathroom and one en-suite)
- Cold water supplies to the pump must be taken from the opposite side of the cold water storage tank to the cold water mains inlet
- Multiple cold water storage tanks must be linked in 28mm pipe work and the bottom of the tanks must be at the same level
- Hot water supply to the pump must be via a Salamander approved flange
- AV couplers must only be finger tight plus one quarter turn
- The maximum static head should be 10m (equivalent to 1.0 bar pressure) – only exception is the ESP 50 CPV which is 5m (equivalent to 0.5 bar pressure)
- We recommend the pump is activated for at least 5 minutes every 4 weeks

Don’ts

- Never fit the pump to the cold water mains
- Never fit the pump to communal risers
- Never use a shared water supply
- Never put a non-return valve (NRV), inverted loop, restrictive balofix or an air vent on supply pipe work to the pump
- The hot water supply to the pump must not exceed 60-65°C
- Never twist the anti-vibration (AV) couplers or bend more than 35°
- Never use mechanical tools to tighten coupler nuts as this may cause damage and will invalidate your warranty
- Never use jointing compounds, Boss White, Hemp or steel wool
- Solder fluxes must not come into contact with the pump or AV couplers
- Never install in a bathroom unless in an enclosed space and access is only possible with an appropriate tool
- Never pump directly to or from another shower pump
- Never connect to a secondary return tapping on a hot water cylinder

Please follow these installation instructions carefully. Failure to install your pump in accordance with these instructions will invalidate your warranty.

1. Location of the pump

The best possible location for the pump is at or near the base of the cylinder at least 600mm below the bottom of the cold water storage tank. Where it is not physically possible to locate the pump next to the cylinder, the pipe run from the hot water cylinder to the pump must not exceed 4m in 22mm pipe work.

1.1 Cooling and ventilation

The pump should be placed in a position where there is an adequate air flow to cool the motor and separated from any other appliances that generate heat. It should be installed in a clear space allowing 100mm additional space at each side, the ends and top of the pump.

1.2 Frost protection

Loft mounted pumps must be protected from frost damage.

2. Hot and cold supplies to the pump

Never fit the pump directly to the cold water mains.

Never fit to communal risers (e.g. block of flats) or secondary circuits that are pumped. The pump must be fed by exclusive hot and cold water supplies (i.e. not shared with other services) and in 22mm pipe work (Note: for the RSP 50 a maximum of 2m of 15mm inlet pipe work).

The hot supply pipe work should be a maximum of 4m from the cylinder in 22mm pipe work.

All up and over pipe work must be vented at the highest point on the outlet of the pump

and a non-return valve (NRV) may require to be fitted to the hot outlet only (Note: for the ESP range this is for the ESP 50 CPV and ESP 55 CPV only).

2.1 For pumps positioned above the hot outlet, hot water cylinder or in a loft

An anti-gravity loop (AGL) off a No stop Essex Flange must be used when it is sited above the dome of the hot water cylinder as it prevents air tracking up into the pump chamber and back siphoning of the water again, creating air in the pump chamber.

Never put a non-return valve, inverted loop, restrictive balofix or an air vent on the supply pipe work to a pump.

Where the pump is servicing two or more bathrooms, the cold water supply to the cylinder must be in 28mm pipe work.

2.2 Cold water storage

Ensure that the cold water storage capacity is adequate for all of the household requirements (minimum 50 gallons per bathroom, 80 gallons for one bathroom and one en-suite shower room).

Ensure the cold water supplies to the cylinder and the pump are taken from the opposite side of the cold water storage tank from the cold mains inlet.

Figure 1: Tank inlet and outlet position

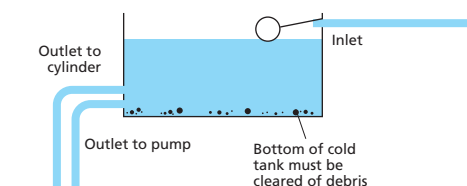

Multiple cold water storage tanks **MUST** be linked in 28mm pipe work with the bottoms of the tanks at the same level.

Figure 2: Linked cold water tanks

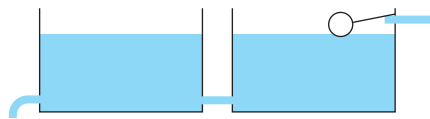

2.3 Hot water requirements

The stored hot water temperature must not exceed 60-65°C (see page 16, Stored hot water temperature).

The hot water supply to the pump must be via a Salamander approved method:

The best hot connection from the cylinder is either

- A 3/4" NO STOP ESSEX FLANGE. See Figure 3 or
- Alternatively a Salamander S flange or other approved top entry flanges. See page 16.
- Never fit to top entry flange if the pump is fitted above the cylinder.

Figure 3: Hot water supply method

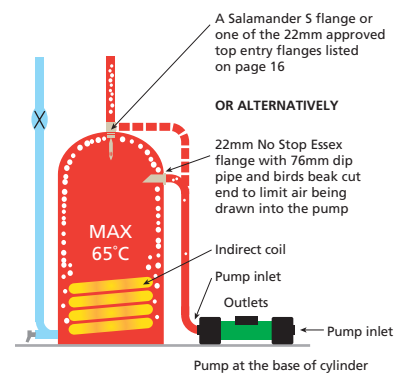

3. Anti-vibration couplers (Hoses)

The anti-vibration (AV) couplers are designed to limit the transfer of pump vibration to the associated pipe work. All Salamander AV couplers are 3/4" BSP x 22mm push fit with built-in isolating valves. Note: the RSP 50 and RGP 50 are supplied with 15mm couplers with isolating valves on the inlets and outlets.

Figure 4: Isolating valves

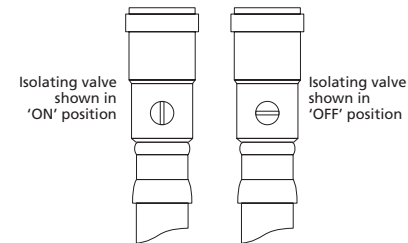
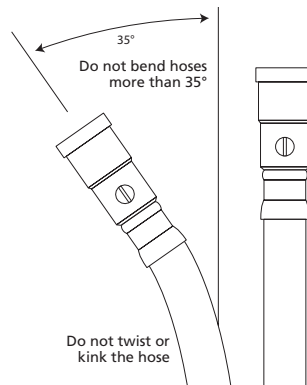

Figure 5: Couplers



Ideally the AV couplers should be straight, but they must **NOT** be twisted or bent more than 35° (this invalidates the warranty). See Figure 5.

Each single pump is supplied with two couplers; one angled and one straight. The angled coupler should be attached to the pump inlet (on the side) and the straight coupler should be attached to the pump outlet (on the top).

Each twin pump is supplied with four couplers; two angled and two straight.

For all pumps, the inlets are on the side of the pump and the outlets are on the top of the pump.

The AV couplers **MUST** only be tightened to finger tight plus one quarter turn. Mechanical tools must **NOT** be used to tighten coupler nuts as this may cause damage which will invalidate your warranty.

4 General plumbing

The installation must comply with the relevant requirements or local by-laws.

The pump **MUST** be mounted upright (shaft horizontal, not screwed down).

Jointing compounds, Boss White, hemp and steel wool **MUST NOT** be used. Solder fluxes must not come into contact with the pump or the AV couplers.

The maximum static head should be 10m (equivalent to 1.0 bar pressure) with the exception of the ESP 50 CPV pump where the maximum static head should be 5m (equivalent to 0.5 bar pressure).

5 Electrical requirements

The pump must be connected to the electrical supply using the mains cable with the attached plug. This plug must be connected to an accessible socket that has been installed in compliance with BS7671 (I.E.E. Wiring regulations). The plug must be accessible at all times.

The pump must not be installed in a bathroom unless it is installed in an enclosed space accessible only with the use of a tool.

If the supply cord is damaged, it must be replaced by the manufacturer, its service agent or similarly qualified person in order to avoid a hazard.

Higher rated fuses must **NOT** be used. Fuses should be as per the table below:

Pump	Fuse
RGP Range	3 amp
RSP 50	3 amp
RSP 75, RSP 100	5 amp
RHP 50	3 amp
RHP 75, RHP 100	5 amp
RHP 140	7 amp
ESP 55, ESP 80, ESP 120, ESP 50	3 amp
ESP 75, ESP 100, ESP 150	5 amp
ESP 140	7 amp

We recommend that the pump is run for at least 5 minutes every 4 weeks in order to exercise all working parts.

Typical installations – RSP and RHP pumps

Right Shower Pumps (RSP)

Designed purely for showers. The right shower pump is best determined by the customer's expectations and choice of shower head.

Figure 6: Right pump fitted in loft above cylinder outlet

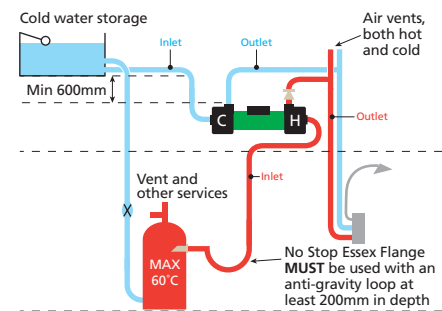

In positive head systems, allow for increased resistance of long pipe runs with multiple bends. The natural flow from the shower head or other outlets MUST be at least 1 litre/min per side (hot or cold).

Figure 7

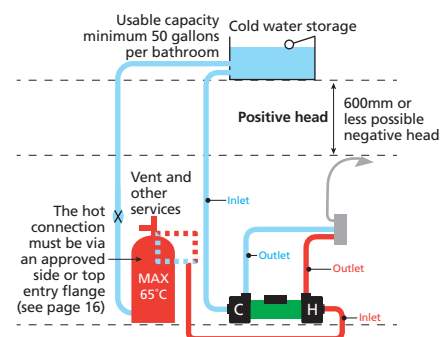

Right whole House Pumps (RHP)

Equipped with a bypass loop. Selection of the Right whole house pump for a system will be determined by the resistance of, quantity of and the pressure required by, the outlets.

In these systems

- Toilets MUST be fitted with an equilibrium ball valve.

Figure 8: Whole house system with any RHP twin pump

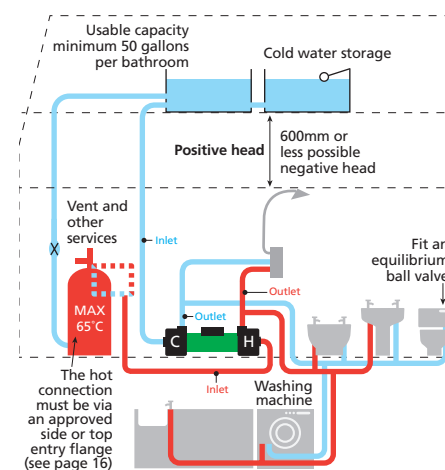

Either side of these pumps can be used for hot or cold water.

ESP CPV pumps – system operation and L.E.D. indication

With electronic system protection ESP CPV pumps are the culmination of four years intensive research to develop advanced pumps incorporating micro electronic technology and sensors capable of:

- Positive or negative head operation
- Supply water temperature sensing
- Dry run protection
- Sensing chronic aeration or water starvation
- L.E.D. indication of system function and any unforeseen system malfunction

ESP CPV pumps have been designed to protect customers by responding to unexpected or unforeseen conditions.

ESP CPV pumps will only be switched 'OFF' if the unexpected or unforeseen conditions are serious.

System operation and system malfunction is indicated via five L.E.D.'s located on top of the pump junction box, see Figure 9.

For ESP CPV pumps only **NON-RETURN VALVES MUST NOT be fitted in the discharge pipework between the pump outlets and system outlets unless specified by Salamander.**

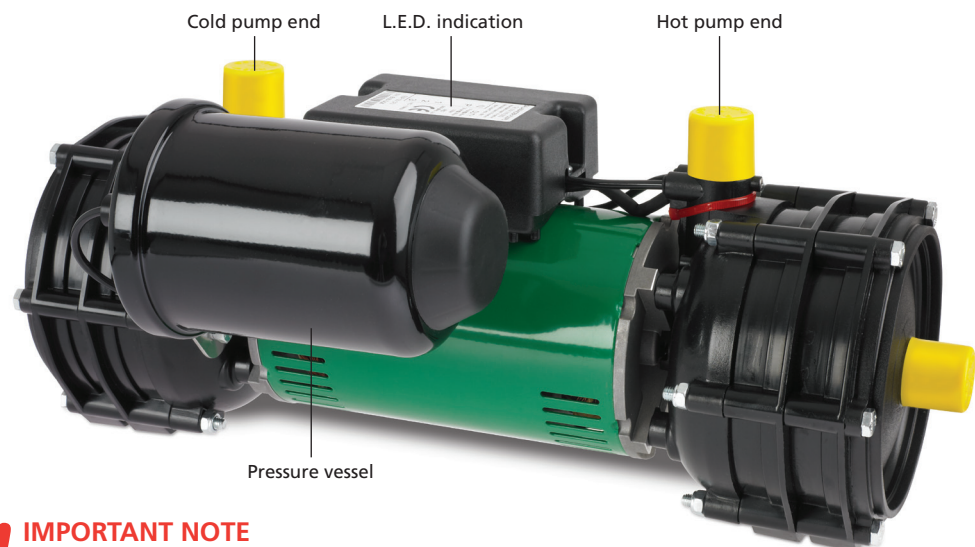

! IMPORTANT NOTE

The HOT and COLD pump ends are identified by RED (hot) and BLUE (cold) tie wraps. See above illustration.

Figure 9: L.E.D. indicator

ANY RED L.E.D. 'ON' indicates PUMP OFF indicating unforeseen system malfunction

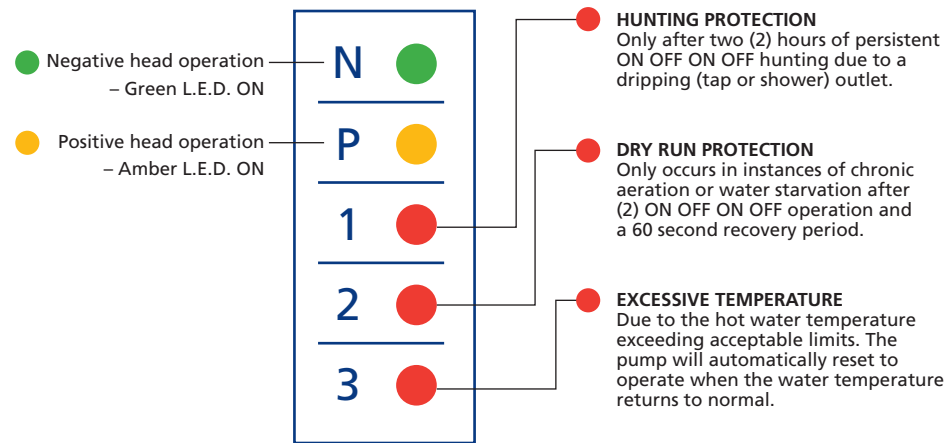

An ESP pump is capable of operating in positive or negative head. Should you need to switch from one to the other please follow the instructions below:

To set the pump in Negative head:

- 1 Turn off the power to the pump, then turn it back on.
- 2 The pump will run showing an amber light (L.E.D.) then will stop.
- 3 Wait until a green light shows on the pump and turn the power off for 5 seconds.
- 4 Turn the power back on to the pump.
- 5 The pump will repeat this sequence but do not turn off the pump, at the end of the sequence the green light will flash then go off and then come back on and stay on.
- 6 The pump has now been set in negative head.

To set the pump in Positive head:

- 1 Turn off the power to the pump, then turn it back on.
- 2 The pump will run showing the amber light then will stop – switch it back off immediately.
- 3 Wait 5 seconds then turn the pump back on.
- 4 The amber light will come on and go back off again. The green light will come on and go back off again. Finally, the amber light will come back on and will remain on and the pump is now in positive head.

ESP CPV pumps (negative head)

An ESP CPV twin to a bathroom in a loft-conversion.

Figure 10: Negative head

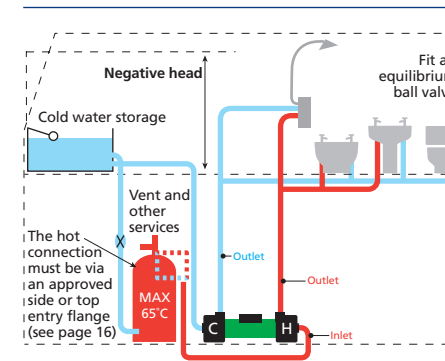

Negative head systems

Negative head systems are those where the shower head or other outlets are above or are level with the cold water storage tank, or when the low head pressure does not provide enough natural flow to the outlet. Salamander positive head pumps require a natural flow of only 1 litre per 30 seconds per flow switch. Negative head systems are typically loft conversions or flats with showers which have self-contained hot and cold water services. See Figure 10.

Fully automatic negative head systems are best accommodated by using an ESP CPV pump (the fully integrated option which has a built-in pressure vessel and electronic system protection).

The requirements of large systems including multiple body sprays and or boosted supplies to two or more bathrooms are best served with Right ESP CPV Super Booster with integral pressure vessels. See Figures 16, 17 and 18.

ESP CPV pumps (positive head)

ESP twin pump to a whole house system. In these systems TOILETS must be fitted with equilibrium ball valve(s).

Figure 11: Positive head

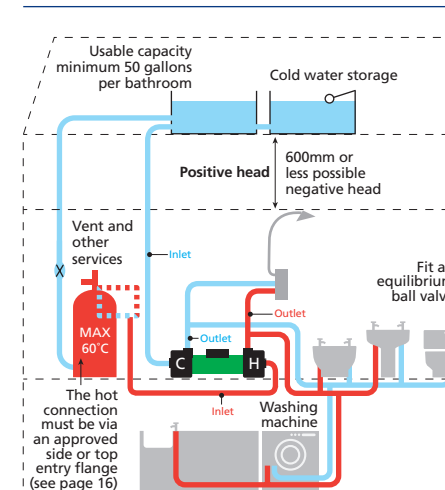

ESP CPV

ESP CPV pumps can be commissioned to operate in negative or positive head. The correct procedure for commissioning is therefore extremely important.

Typical installations – ESP CPV pumps

ESP CPV pumps to shower columns or steam shower cabinets

These will be required to operate NEGATIVE HEAD where pipework runs above tank.

Figure 12: ESP CPV to a shower column

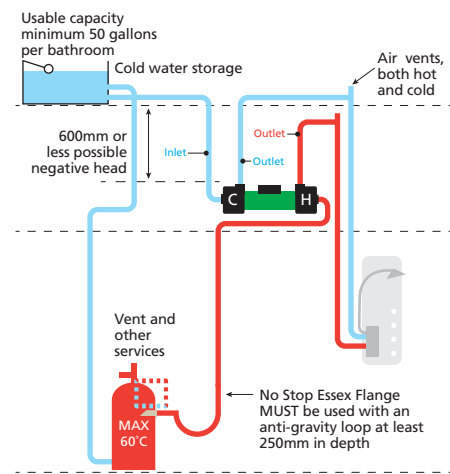

ESP CPV pump to a shower cabinet.

Shower columns and steam shower cabinets in larger whole house systems or systems with multiple bathrooms will be best served by an ESP CPV Super Booster. See Figures 16, 17 and 18.

ESP CPV single (negative head)

The following systems are best accommodated by using a Right ESP CPV single pump (the fully integrated option) which is complete with a pressure vessel and electronic system protection.

Right ESP CPV single pump to boost tank fed supplies to instantaneous electric showers and water heaters.

Figure 13: Instantaneous electric showers and water heaters

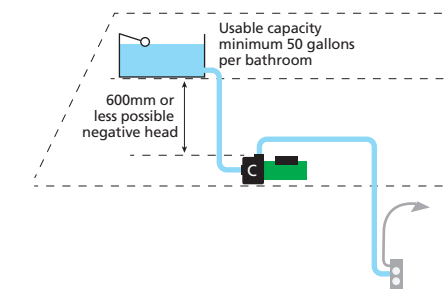

Tank fed, pressurised cylinder or Combi boiler system with Right ESP CPV single pump to boost the hot supply water pressure and cold water mains supplies 'cold' to shower, bath, basin and toilet.

Figure 14: Pressurised cylinder or Combi boiler system

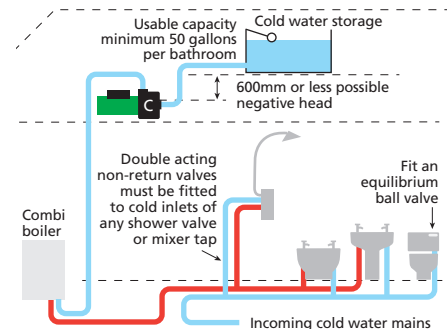

Tank fed (hot) with cold water mains cold systems MUST use Right ESP CPV.

Never use an ESP single pump after the shower valve or before an open outlet.

Figure 15: Tank fed (hot) with mains cold system

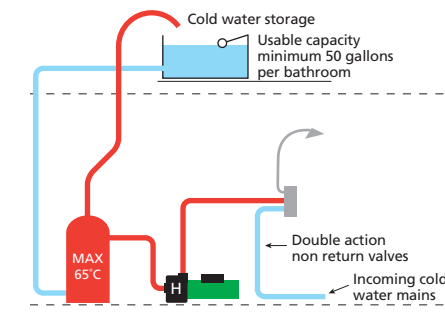

ESP CPV Super Booster (super booster pack)

Use the ESP 120 Super Booster for un-vented mains pressure systems and pumped cold water around the house, these two options must be from cold water storage tanks.

Figure 16: Super booster

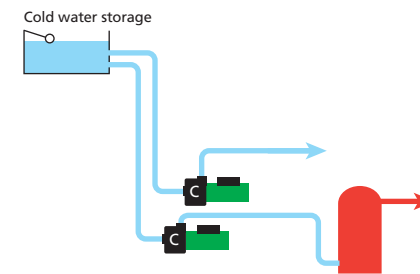

Large whole house system with the ESP CPV Super Booster hot and cold pumps mounted in the airing cupboard.

Figure 17: Super booster whole house systems

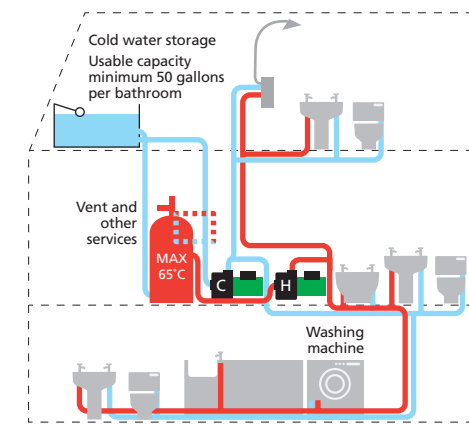

Sports Complex with multiple showers.

Figure 18: Super booster to multiple showers

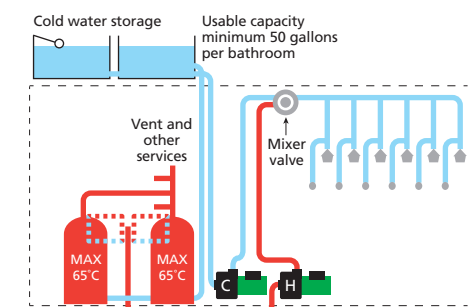

Commissioning

Before you finish

- Flush inlet pipework and carefully fill pump with water by discharging water from the outlet flexible coupler into a container.
- Fit pump inlet filters.

It is CRITICAL to discharge water through the pump into a container using natural flow before connecting the pump to outlet pipework in order to ensure the air has been discharged from inlet pipework and pump chambers. This will not happen if the outlet pipework is connected to the pump. The best method is:-

Figure 19

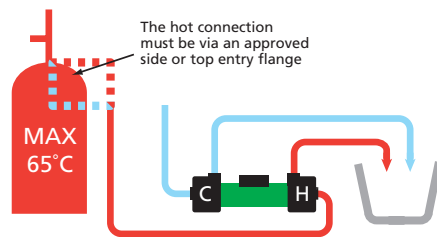

- Connect discharge pipework.
- **Check that all the pump isolating valves are open.**
- Fill system. Check for leaks.

- **DO NOT RUN PUMP DRY – to do so will cause irreparable damage to your pump and will invalidate your warranty.**
- Open shower mixer valve/system outlets to maximum hot and cold to check the natural flow (unpumped) flow of at least 1 litre per minute – positive head systems.
- FOR RIGHT ESP CPV pumps see notes on page 7.
- Open hot water outlets fully for 5 to 6 seconds and then turn outlets off. Then open cold water outlets fully for 5 to 6 seconds and turn outlets off. If flow is poor and inconsistent repeat above steps until flow is steady.
- Repeat 2-3 times.

Helpful PumpWise guidelines

Cold water supplies and storage

Recovery of cold storage

The typical recovery rate of a 1/2 inch high pressure part II BS1212 ball valve is:

15PSI (1.0 bar)	0.97 galls/min
30PSI (2.0 bar)	1.34 galls/min
40PSI (2.7 bar)	1.58 galls/min
60PSI (4.0 bar)	1.94 galls/min

Aeration of pump and cylinder from a cold water storage tank

This occurs when the incoming cold mains ball valve is positioned above the cold feeds to the cylinder and to the pump – aerated water is drawn into the pump as illustrated.

Figure 20: Aeration

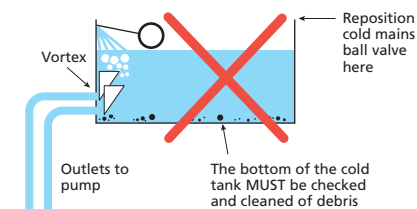

Chronic aeration of the pump occurs when this problem is combined with inadequate storage capacity and/or when the volume of water drawn by the pump and other services exceeds the refill rate and creates a vortex which draws air and possibly debris into the pump.

Cold storage usable capacity

The usable capacity of cold storage is easily calculated as the capacity of water in the cold tank above the cold feeds to the cylinder, the pump and other outlets – see formula.

Formula for calculation on rectangular tank:

Depth (15") x width (23") x length (36")
 = 12,420 cu inches

Volume cu inches (12,420) x 0.01639
 = 203.56 litres

Volume litres (203.56) x 0.22
 = 44.78 gallons.

Formula for calculation on circular tank:

Depth (15") x radius (17") x radius (17")
 x 3.142 (Pi)

= 13,621 cu inches

Volume cu inches (13,621) x 0.01639
 = 223 litres

Volume litres (223) x 0.22
 = 49 gallons.

Figure 21

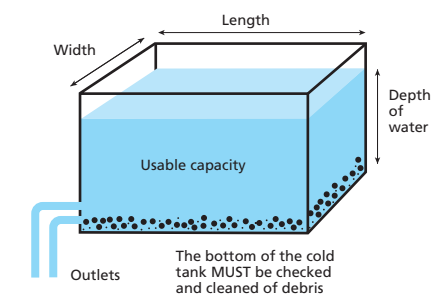

Pre-plumbed direct or indirect combination units

These are purpose-made units typically for use in multiple flat developments, usually in towns and cities where it is advantageous and desirable to provide the occupants with completely independent hot and cold water services.

In these systems the ideal pump is an ESP 50/75 CPV. For alternative types of combination units see Elson, Figure 23 and Fortic (type), see Figure 24.

Figure 22: Pre-plumbed direct or indirect combination units

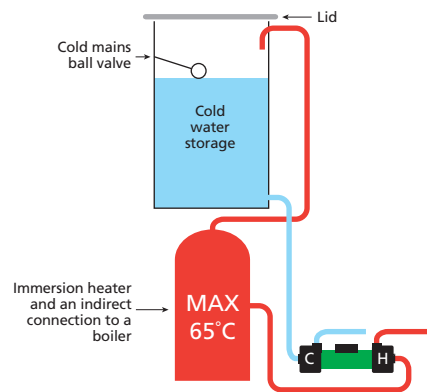

Elson (type) tanks

In these systems it is important to ensure the hot and cold water storage capacity is adequate for the type of pump to be used. The refill ball valve on the small cold tank which refills the hot tank is correctly set to prevent aeration of the hot supply water to the pump.

Figure 23: Elson (type) tanks

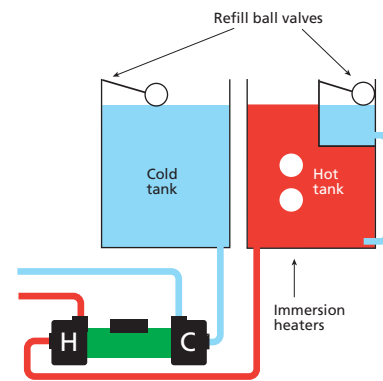

Helpful PumpWise guidelines

Water starvation protection, pipework arrangements and stored hot water

Fortic (type) tanks and pre-assembled units

Typically used in very small flats and houses. Not usually with sufficient water capacity of cold water for pumped systems.

Figure 24: Fortic (type) tanks and pre-assembled units

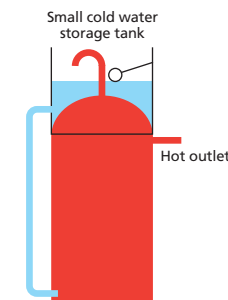
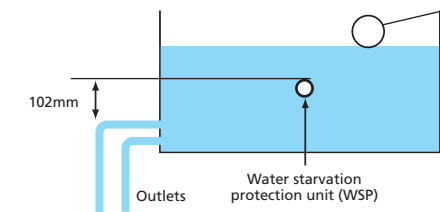

Figure 25: Water starvation protection unit (WSP)



Shower head size vs bar pressure

The size of a shower head dictates the bar pressure of the pump required to deliver the expected performance of the shower.

Shower head diameter	Bar pressure
Up to 5cm	1.5 bar
5-10cm	2.0 bar
10-12.5cm	2.5 bar
More than 12.5cm	3.0 bar

Anti-gravity loops

An anti-gravity loop (AGL) must always be fitted to systems where the pump is positioned above the hot outlet from the cylinder. The AGL which limits aeration of the hot supply to the pump is formed by bending the pipework downwards for 250mm, as it exits the Essex Flange, before rising again to the pump. See Figure 26 overleaf.

Water starvation protection

In systems where it is absolutely not possible to increase the usable cold water storage capacity to meet the increased demand of a pumped system; a water starvation protection unit (WSP) may be considered.

The WSP is a Salamander level switch which must be positioned 102mm higher than the highest outlet from the cold water storage tank. When the water level drops too far the WSP will switch off the pump until the cold water storage level is recovered.

Figure 26: Anti-gravity loop (AGL)

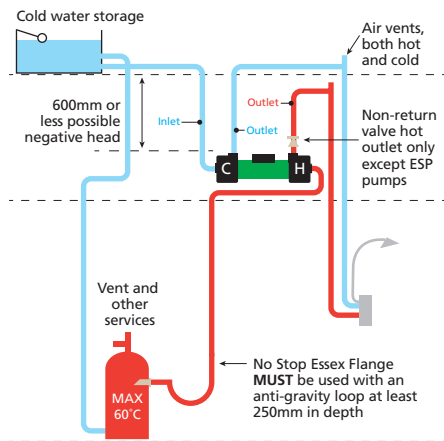

Combi boilers and water heaters

As these appliances are invariably supplied directly from the cold mains – they are not normally suitable for booster pumps. The exceptions are featured in Figure 14 on page 10.

Figure 27: Combi boilers

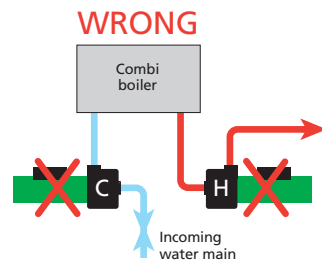

Horizontal cylinders

As horizontal (torpedo) cylinders are problematic for boosted systems consult PumpWise for guidance and correct use of an approved top entry flange.

Figure 28: Horizontal cylinders

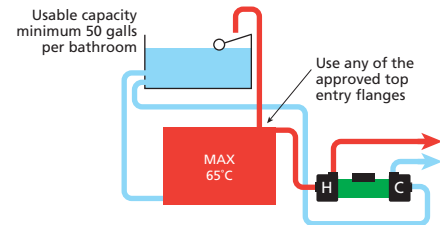

Approved flanges (cylinders)

The 22mm No Stop Essex and the other approved top entry flanges with extension pipes into the cylinder represent the best known means of ensuring minimal aeration of the hot supply water to the pump. The No Stop Essex flange is in all circumstances the best option.

S flange

Complete with compression 'pump' and 'open vent' connections. Also supplied with an adaptor to connect to 1" 'male' and 'female' top entry cylinders.

Figure 29: S flange

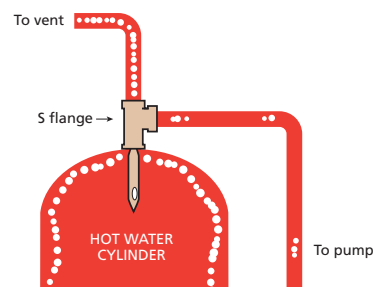

York flange

These may be used in systems where the hot water requirement is less than 20 LPM.

Warix flange

- A The Vent connection **MUST** be from side in Warix Flange.
- B The supply connection to the pump **MUST BE FROM THE TOP** of the Warix Flange via a 22mm compression elbow and thereby avoid inverted loops.
- C In systems where there are one bathroom and an en-suite shower. Or two or more bathrooms the cold feed to the cylinder **MUST** be in 28mm pipework.

Figure 30: Approved flanges

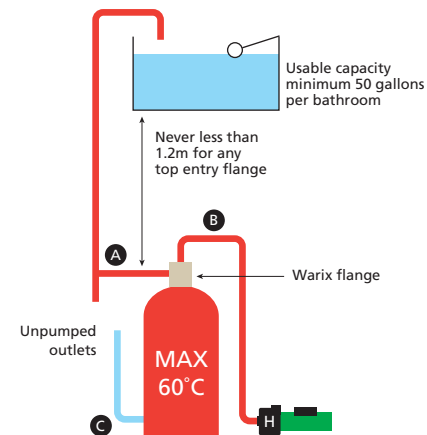

Inverted loops

An inverted loop in the supply pipe-work to the pump, particularly on the hot side as illustrated; is likely to:

- interfere with the initiation and smooth operation of the pump.
- restrict the supply water to the pump and risk internal mechanical damage.

Figure 31: Inverted loops

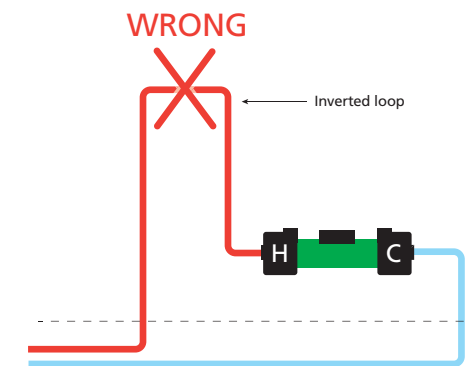

Prismatic cylinders and Andrews type water heaters are not suitable for pumped systems.

Water hammer protection

Water hammer most commonly occurs in systems where there are long pipe runs supplying solenoid activated appliances e.g. washing machines or outlets with quick acting/turn taps/ valve(s). The harmful effect of water hammer shock waves can be cushioned by fitting a pressure vessel unit, into the supply pipework as close as possible to the outlet from which the shock waves are originating.

Figure 32: Water hammer protection

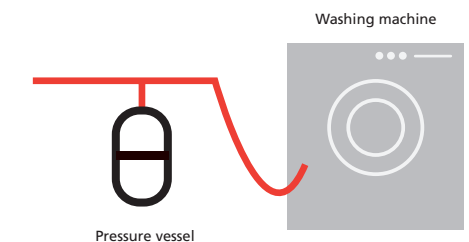

Pump hunting protection

In negative head systems all the discharge pipework after the pump is pressurised. In such systems there exists the possibility the pump will hunt ON-OFF-ON etc at intervals. This will happen:

- if all outlets are not fully closed
- if there is a leak at a connection
- if boosted toilets are not fitted with equilibrium ball valves
- or as residual hot water contracts in long pipe runs.

The irritating effects of hunting are cushioned by the pressure vessel which is an inbuilt feature of ESP CPV pumps.

Stored hot water volume

In calculating the volume of the stored hot water requirement it is important to consider:

- number of bathrooms, with particular attention to the size of the bath
- number of persons in household
- time spent in shower e.g. 10mins in a 5 gall/minute shower will use up 50 galls of the cold water storage capacity approx 60% of which (30 gallons) will be hot water from the cylinder.

Stored hot water temperature

Extract from BS5546:1990 (Current)

"The mean temperature of the stored water should not normally exceed 60°C and in a combined central heating and domestic hot water system it is recommended that the stored water temperature is controlled independently from that on the primary circuit".

Extract from BS6700:1997

"Under normal conditions the temperature of stored hot water should never exceed 65°C. A stored hot water temperature of 60°C is considered sufficient to meet all normal requirements and will minimise scale deposits in hard water areas".

Effective control of stored hot water is simply achieved by use of a cylinder thermostat and zone valve or direct acting thermostatic valve (e.g. tapstat).

In systems where the stored hot water temperature is not controlled eg Aga solid fuel appliance or very crudely by the boiler thermostat, use a HWS Blending valve controller.

HWS Blending valve controller

The HWS Blending valve controller is designed to protect booster pumps in systems where the temperature of the stored hot water is uncontrolled – see below.

Figure 33: HWS Blending valve controller to floor mounted pump

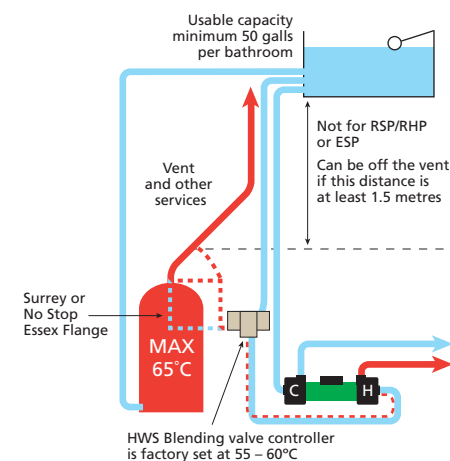

General specification

Applications

All Salamander pumps are designed to boost low pressure hot and cold supplies from tank-fed services.

Voltage

220-240 volts 50 Hz.

Motor type

Capacitor start and run induction type motor with stainless steel shaft and in-built resetting thermal protection (complies with BS5000 part 11).

Pump materials

All moulded components are manufactured from Acetal Copolymer.

Maximum head

ESP 50 CPV and ESP 55 CPV 5 metres
 All other pumps 10 metres
 Pumps fitted with RCM3 maximum 3 metres static head.

Pump noise

With the technological advances achieved in Right pumps and ESP pumps, Salamander has taken another step forward in the quest to supply all our customers with even quieter centrifugal pumps. Despite this no pump is completely silent.

Correct installation will minimise vibration and transmission noise.

Mechanical seals

Scale deposits in water supplies can cause the mechanical seal to stick if left for long periods without use. We recommend the pump be ran at least five minutes every four weeks to 'exercise' all working parts.

Connections

3/4" BSP male.

Initiation

Fully automatic, flow switch operated, requiring 1 litre in 30 sec per side or 2 litre in 30 sec mixed. Except Right ESP CPV pumps when required to operate in negative head mode.

Temperature

Maximum fluid temperature 65°C.

Standards and approvals

Splash proof rating IPX2.

Complies with the requirements of current British and European safety standards for household and similar electrical appliances.

Complies with European Community Directives (CE).

The company operate a policy of continuous development and reserves the right to change any of the specifications of its products without prior notice. All information data and illustrations given in this leaflet may be subject to variation.

Trouble shooting

Fault	Probable cause	Recommended solution
Pump will not start	Electrical	Check power supply Check fuse Check circuit breaker
	Inlet/outlet connections incorrect	Check that connections are plumbed the correct way round and all valves are open
	Insufficient gravity flow	Check that installation complies with Salamander instructions Check suitability of pump – is installation in negative head (see page 9) Check inlet filters are not blocked Check flow rate min of 2l/min required on both hot and cold
	Float sticking in outlet	Ensure no debris is in outlet area
	Flow switch malfunction	Contact service
Pump will not start – ESP CPV pumps additional checks	Pump in wrong mode	Ensure pump is commissioned in correct mode for system (i.e. positive or negative head)
	L.E.D. warning light lit	See below conditions
	L.E.D. 1 lit (pump hunting)	Check all outlets are fully closed and there are no leaks on outlet pipe work If fitted to toilets ensure ball valve in cistern is not passing water Ensure equilibrium ball valve fitted Ensure pump is fitted to Salamander instructions
	L.E.D. 2 lit (aeration – starvation of water)	Check cold water storage is correct for installation and pump is fitted to Salamander instructions Flange fitted Check pump filters are clear of debris
	L.E.D. 3 lit (temperature)	Is effective temp control fitted (cylinder stat or HWS/TMV valve) Is the temperature set to 65°C maximum

Fault	Probable cause	Recommended solution
Reduced/ intermittent flow	Incorrect or no anti-aeration flange fitted	Check that installation complies with Salamander instructions
	Insufficient gravity flow	See above
	Blocked inlet filters	Ensure that all filters and shower head are free from debris
	Couplers restricting flow	Ensure that all AV couplers are straight and not bent or distorted
	Air in system	Run system on full hot with pump switched off (i.e. gravity only) for several minutes Check cold water storage is correct for installation and pump is fitted to Salamander instructions Ensure cold water refill rate is adequate for installation Check that vents are fitted as described in instructions
	Wrong size pump for system	Ensure pump is sufficient to run the equipment
Pump starts with all outlets closed	Hot temp set too high	Reduce cylinder stat setting to 65°C max or fit HWS/TMV
	Leak in system	Check for leaks
Pump starts with all outlets closed	Outlet open	Ensure all outlets are fully closed or capped – i.e. no dead legs in pipework
	Pump is noisy	Air in system
Pump is noisy	Pump vibrating on surface	Ensure rubber feet are fitted to pump
	AV couplers causing vibration	Ensure that all AV couplers are straight and not bent or distorted
Pump is leaking	Pump exposed to mains water pressure	Check that installation complies with Salamander instructions
	Pump has suffered chemical damage	Ensure that the pump has not come into contact with chemical substance i.e. solder flux
	Pump exposed to excessive temperature	Is effective temp control fitted (cylinder stat or HWS/TMV valve)
	Pump appears to have leaked but not sure	Check leak is not from fitting in pipework above pump

PumpWise and warranty

0191 516 2002

Monday to Thursday 8.30am to 5.30pm
Friday 8.30am to 5.00pm.

PumpWise is the cornerstone of Salamander's support service to customers and the means by which our customers are guaranteed:

- Selection of the right pump for the job
 - With more than 30 pumps in our range, the PumpWise team can help you to choose the pump that's most suitable to your specific installation
- The avoidance of installation pitfalls
 - Due to the technical nature of our products, it is essential that they are fitted according to our installation guidelines. The PumpWise team are available to talk through any installation questions and provide technical support and guidance.
- A third year's warranty FREE
 - All of our pumps come with a full two year warranty, but following installation of your new pump, if your installer calls our PumpWise team, registers your pump and runs through the system installation you may be eligible for a third years warranty free.

Our PumpWise commitment

Our PumpWise helpline is here to help you and we aim to provide a support service second to none. Installers and customers can be sure of a speedy response to requests for technical help, guidance and advice.

Your warranty

Salamander customers benefit from a full two year warranty on the RSP, RGP, RHP

and ESP ranges. This warranty will operate from the date of purchase and is subject to the installation guidelines being followed correctly (please refer to our Pre-Installation Checklist, on page 2 and our Commissioning Checklist, on page 12). This warranty can be increased, free of charge, if the installer contacts our PumpWise team to register the pump and run through the installation with our technical team. Providing the pump has been installed according to our guidelines, you will receive a third year's warranty free of charge (UK only).

Please complete and return the attached warranty card.

Extended warranties

In addition to the three year warranty available free of charge following the successful installation of your pump, there is an optional Extended Warranty Scheme (UK only). The Extended Warranty Scheme exists to protect customers from any unexpected or unforeseen pump breakdowns. Participation in the Extended Warranty Scheme is activated by completion of an Extended Warranty Application Form and the payment of a nominal fee.

For further details please contact the PumpWise team:

Telephone: 0191 516 2002

Fax: 0191 548 4445

Email: tech@salamanderpumps.co.uk

PLEASE NOTE: Incorrect installation may invalidate the pump warranty. Please read the full terms and conditions opposite.



To the installer

Please follow the guidelines for installation provided in this brochure and call the PumpWise helpline for installation advice. Once installation has been completed and the system has been tested to your satisfaction, please assist the customer in completing the prepaid Warranty Card.

Terms, conditions and warranty

1 The Scope of the Warranty

SALAMANDER PUMPED SHOWER SYSTEMS LTD ("the company") Warrants subject to the terms and conditions below for the Warranty period(s) specified in paragraph 3 that the Company shall:

Repair or replace free of charge the product(s) specified on the Warranty card or any component part thereof (together referred to as "the equipment") which shall in the opinion of the Company have proved defective by reason only of the Company's materials or workmanship providing always that the Company shall be under no obligation whatsoever under this Warranty to repair or replace equipment which shall have been misused modified altered or transformed in any way without the consent in writing of the Company or if any component or accessory shall have been replaced by a type not specified by the Company or if the equipment is incorrectly installed or operated or used other than as described in the instruction manual or if any servicing or repair of the equipment shall have been carried out otherwise than by an authorised Company dealer appointed by the Company ("dealer").

The Company's liability under this Warranty is limited to the said repairs or replacement and shall under no circumstances extend to any financial loss or damage including consequential losses alleged to have been suffered by the claimant.

Subject as provided in this warranty and except where the equipment is sold to a person dealing as a consumer all warranties, conditions or other terms implied by law are excluded to the fullest extent permitted by law.

Nothing in this warranty shall exclude liability for death or personal injury caused by the Company's negligence

2 Terms and conditions

This Warranty shall only be enforceable by you if the following terms and conditions have been complied with:

- a That the pump has been installed in accordance with the installation instructions, guidance and advice

contained within the installation and warranty guide and/or provided by the Salamander help desk.

- b You are the original purchaser of the equipment from a dealer and not an assignee or subsequent purchaser of the equipment.
- c You must evidence the date of purchase by retaining the original invoice from the dealer. Without such evidence the Company reserves the right to reject any such claims under the terms of this Warranty.
- d Within 15 days of delivery of the equipment to you the Warranty card is accurately completed and returned to the Company.
- e Within thirty days of discovery of a defect giving rise to liability under paragraph 1 above you give notice thereof in writing to the Company.

3 The Warranty periods

The Warranty periods referred to in paragraph 1 above are as follows:

- a Products manufactured by the Company 2 years from date of purchase provided the warranty card is completed and returned to the Company within 15 days of purchase.
- b Products supplied by the Company, but not of the Company's manufacture – 1 year from date of purchase.
- c The warranty period in respect of any product repaired or replaced under the warranty shall be part of the above period(s) which remain unexpired.
- d In the event of a claim for repairs or replacement being made under the terms of this Warranty in the circumstances where in the opinion of the Company the defect has not been caused by the Company's materials or workmanship then the Company reserves the right to charge the claimant at its current hourly rates and list prices in respect of any service engineer's time and any replacement of parts.
- e This Warranty is given in addition to and does not affect your statutory rights as a consumer.
- f This Warranty is valid and enforceable for equipment purchased and used exclusively in the UK and The Republic of Ireland only.
- g Where the Company makes a replacement the equipment replaced shall be returned to the Company forthwith and shall become the property of the Company.
- h No authority has been given to any person, firm or company to vary the terms of this Warranty.

Notes

Lined area for notes



Freeport RLXE-JHHY-HLHJ
Salamander Pumps
Unit 2c Colima Avenue
Sunderland, SR5 3XE