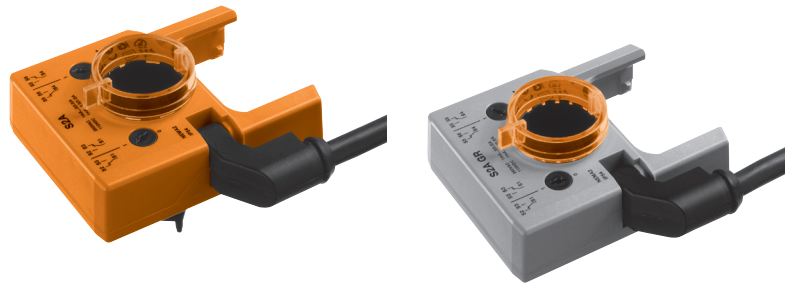

Auxiliary switches for damper actuators and rotary actuators

- One or two switches (SPDT, single-pole double-throw)
- Adjustable switching point

Overview of types

	Type	No. of switches	Cable	Material	Type	No. of switches	Cable	Material
Housing colour, orange	S1A	1 x SPDT	1 m, 3 x 0.75 mm ²	PVC	S2A	2 x SPDT	1 m, 6 x 0.75 mm ²	PVC
					S2A GR	2 x SPDT	1 m, 6 x 0.75 mm ²	FRNC ¹⁾
Housing colour, grey					S2A/300 GR	2 x SPDT	3 m, 6 x 0.75 mm ²	FRNC ¹⁾
					S2A/500 GR	2 x SPDT	5 m, 6 x 0.75 mm ²	FRNC ¹⁾

¹⁾ Option for RobustLine and IP66/NEMA4 actuators

Overview of actuators

	Standard actuators		RobustLine actuators	Very fast running actuators	SuperCap actuators	IP66/NEMA4 actuators
Damper actuators	TM..A..	SM..A..	NM..P..	LMQ..A.. ²⁾	GK..A.. ²⁾	GM..G..
	LM..A..	GM..A..	SM..P..	NMQ..A.. ²⁾	NKQ..A.. ³⁾	SMQ..G..
	NM..A..			SMQ..A.. ²⁾		
Rotary actuators	TR..A..	SR..A..	SR..P..	LRQ..A..	GRK..A..	GR..G..
	LR..A..	GR..A..		NRQ..A..		DR..G..
	NR..A..	DGR..A..				
		DR..A..				

²⁾ For spindle clamp installation on the rear side of the actuator, it is imperative that a Z-SPA adapter be ordered (see «Accessories»).

³⁾ It is imperative that a Z-SPA adapter be ordered for all installations (see «Accessories»).

Technical data

Functional data	Number of switches	See «Overview of types»
	Switching capacity	1 mA ... 3 (0.5) A, AC 250V ☐
	Switching point	Adjustable over the full range of rotation of the actuator (0 ... 1). Can be preset by means of the scale.
	Connection	See «Overview of types»
Safety	Protection class	II Totally insulated ☐
	Degree of protection	IP54 NEMA2, UL Enclosure Type 2
	Low-voltage directive	CE according to 2006/95/EC
	Certification	Certified to IEC/EN 60730-1 and IEC/EN 60730-2-14 CULus according to UL 60730-1A and UL 60730-2-14 and CAN/CSA E60730-1:02
	Mode of operation	Type 1.B
	Rated impulse voltage	4 kV
	Control pollution degree	3
	Ambient temperature	-30 ... +50 °C
	Non-operating temperature	-40 ... +80 °C
	Ambient humidity	95% r.h., non-condensating
Maintenance	Maintenance-free	
Dimensions / Weight	Dimensions	See «Dimensions» on page 3
	Weight	S1A: approx. 200 g S2A (GR): approx. 250 g S2A/300 GR: approx. 520 g S2A/500 GR: approx. 720 g

Safety notes



- The device must not be used outside the specified field of application, especially not in aircraft or in any other airborne means of transport.
- It may only be installed by suitably trained personnel. Any legal regulations or regulations issued by authorities must be observed during installation.
- The device may only be opened at the manufacturer's site. It does not contain any parts that can be replaced or repaired by the user.
- The cable must not be removed from the device.
- The device contains electrical and electronic components and is not allowed to be disposed of as household refuse. All locally valid regulations and requirements must be observed.

Product features

Application	The auxiliary switches are used to signal positions or to execute switching functions in any angular position.
Mode of operation	A form-fit engagement is created between a driver disc and the spindle clamp (Damper actuators) or on the position indicator (Rotary actuators), causing the position to be directly transferred to the trip cams of the microswitches. The switching points can be freely selected within the specified range of rotation by means of a dial. The current switch position can be read at any time.
Installation	The auxiliary switches are attached directly to the spindle clamp (Damper actuators) or on the position indicator (Rotary actuators). The guiding grooves between the housing and the switch ensure a tightly sealing fit.

Accessories

	Description
Mechanical accessories	Adapter Z-SPA It is imperative that this adapter be ordered if an auxiliary switch is required for the damper actuators (Very fast running actuators and SuperCap actuators) and if at the same time the spindle clamp is installed on the rear side of the actuator (e.g. with short-axis installation). An adapter must be ordered for all installations with the NKQ..A.. actuators.

Electrical installation

Wiring diagrams

S1A..

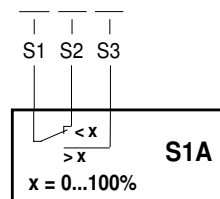

S2A..

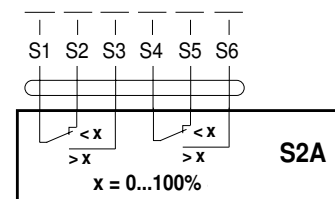

Cable colours:

S1 = violet
 S2 = red
 S3 = white
 S4 = orange
 S5 = pink
 S6 = grey

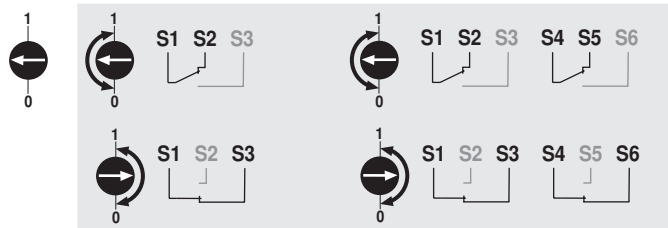

Dimensions [mm]

Dimensional drawings

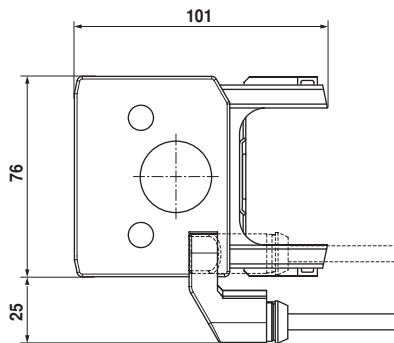

with damper actuators

Damper actuator	A	Damper actuator	A
TM..A.., LM..A..	66	LMQ..A..	80
NM..A..	69	NMQ..A..	83
SM..A..	71	SMQ..A..	89
GM..A..	78	NKQ..A..	87
		GK..A..	94

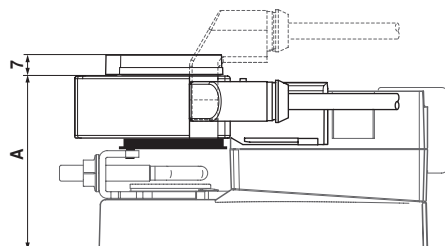

with rotary actuators

Rotary actuator	A	Rotary actuator	A
TR..A.., LR..A..	66	LRQ..A..	80
NR..A..	69	NRQ..A..	83
SR..A..	71	DR..A..	78
GR..A..	78	GRK..A..	94
DGR..A..	78		

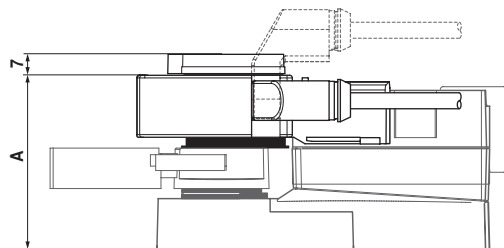

DGR..A..

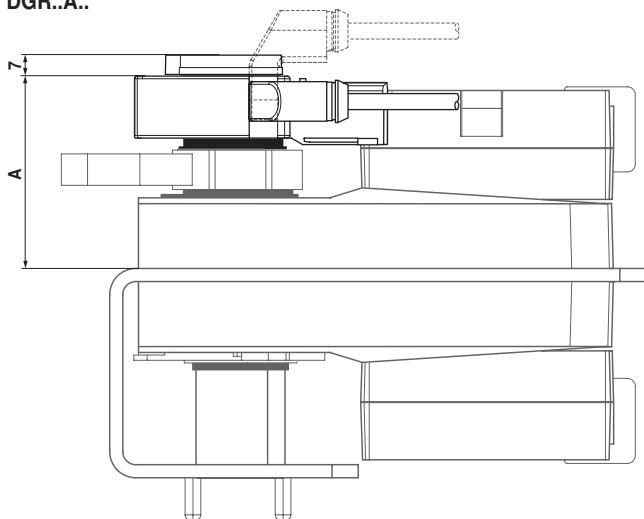

DR..A..

