

PIPING AND ENVIRONMENTAL EQUIPMENT

PIPING

- Durapipe PLX Pipe and Fittings
 - Fibre Glass Pipe and Fittings
-

LEAK DETECTION SYSTEMS

- Leak Detection Systems
-

CONTAINMENT SUMPS

- Underpump Containment Sumps
 - Transition Sumps
-

FLEXIBLE ENTRY SEALS

- Screwseals
 - Boltseals
 - Reducing Boots
-

SPILL CONTAINMENT BOXES

- Browning Spill Safe Boxes
 - Emco Wheaton Retail Single Point Spill Box
 - Browning Secondary Contained Spill Box
 - Valve Boxes
-

MANWAY COVERS

- Composite Manway Covers
 - Aluminium Manway Covers
-

SPILL BOX ACCESSORIES

- Spill Box Seals
- Drain Valves

Technical Guide



Durapipe
PLX
Safe pipework for fuel

Durapipe PLX is a brand from **Durapipe UK**. Durapipe UK has been at the forefront of thermoplastic pipework technology for over half a century. Our pipes, fittings and valves are widely used in a variety of industrial applications around the world.

Manufacturing a wide range of market leading pipework systems for the conveyance of different media, Durapipe systems perform in the most demanding environments.

Durapipe PLX pipework systems have been specially developed for conveying liquid fuels, and are widely used in service stations, commercial and industrial fuelling applications around the world.

Forecourts

Drivers of commercial and private vehicles need fuel to be easily accessible, making the forecourt a necessity of daily life. PLX pipework ensures that fuel is transferred safely from tanks to dispensers.



Power Supply

With an increased reliance on electronic systems in everyday life, sudden loss of electricity can endanger lives and disrupt business services and commerce. Uninterrupted Power Supply (UPS) systems safeguard against this scenario which relies on emergency generators. These in turn need a reliable pipework system for their fuel supply. PLX pipework meets this need.



Transport Refuelling

All modes of transport require fuel to enable them to function as required. Marinas, airports, railway stations and haulage distribution depots all need fuel. Specialist pipe systems are required to meet the needs of these refuelling depots. PLX pipework meets these needs.



Contents

Page	Page
Durapipe PLX Introduction	2
About Durapipe PLX	4-5
Materials	6
Polyethylene	
Protective Barrier Layer	
Introduction and Manufacturing Process	7
PLX; three systems	
Product Specifications	8
Chemical Resistance of PLX	
Standard Dimensional Ratio (SDR)	
Pressure and Flow Ratings	
Flow Nomogram	9
Electrofusion and Spigot Fittings	10-12
Electrofusion Principles	
Barcode Introduction	
Temperature/Fusion Time Compensation	
Secondary Contained EF#SS Fittings	
Transition Fittings	
Pipe End Closures and Interstitial Access Points	
Durapipe PLX Product Innovations	13-14
Close-Fit Unique Transition Fitting	
Close-Fit Extended Transitions	
Secondary Containment Electrofusion Couplers	
In-Line Anchor Fittings	
Large Diameter Tees	
Index to PLX Products	15-17
Introduction to Application Check	18-19
Forecourts	
Power Supply	
Transport Refuelling	
Pipe	20-21
Single Wall Pipe	20
Close-Fit Pipe	21
Pipe-In-Pipe	21
Hockey-stick Bend.....	21
AdBlue® Pipe	21
Electrofusion Fittings	22-27
Single Wall Primary Coupler.....	22
Single Wall Primary 45° Elbows	22
Single Wall Primary 90° Elbows	22
Single Wall Primary Equal Tee.....	23
Single Wall Primary Reducer.....	23
Single Wall Primary End Cap	23
Secondary Contained Coupler with Leads	24
Secondary Contained Pipe Joiners	24
Secondary Couplers	24
Secondary Contained Reducer (Pipe-In-Pipe).....	24
Secondary Contained Reducer (Close-Fit)	25
Secondary Contained 45° Elbows	25
Secondary Contained 90° Elbows	25
Secondary Contained 90° Elbows <i>spigot</i>	25
Secondary Contained Equal Tees	25-26
Secondary Contained Reduced Branch Tee.....	26
Secondary Contained Slip Closures.....	26-27
Secondary Contained Access Tees	27
Secondary Contained Interstitial Access Saddles.....	27
Transition Fittings	28-33
Single Wall Female <i>electrofusion</i>	28
Single Wall Male <i>electrofusion</i>	28
Single Wall Female <i>electrofusion compact flange</i>	28
Single Wall Female <i>spigot</i>	28
Single Wall Male <i>spigot</i>	29
Single Wall Female <i>spigot compact flange</i>	29
Single Wall Female <i>spigot extended</i>	29
Single Wall Male <i>spigot extended</i>	29
Single Wall Female <i>spigot extended compact flange</i>	30
Secondary Contained Close-Fit Female <i>spigot extended</i>	30
Secondary Contained Close-Fit Male <i>spigot extended</i>	30
Secondary Contained Close-Fit Female <i>electrofusion stainless steel</i>	31
Single Wall Stub Flange Assembly <i>spigot</i>	31
Secondary Contained In-Line Anchor <i>spigot</i>	31
Secondary Contained Drilled Flange Assembly <i>spigot</i>	32
Secondary Contained Female <i>spigot</i>	32
Secondary Contained Male <i>spigot</i>	32
Secondary Contained Female <i>spigot compact flange</i>	32
Secondary Contained 90° Elbow Flanged <i>spigot</i>	32
Secondary Contained 90° Elbow Female <i>spigot</i>	33
Secondary Contained Reduced Branch Tee Flanged <i>spigot</i>	33
Stage 2 Vapour Recovery Manifold	33
AdBlue® Single Wall Male Extended <i>spigot</i>	33
AdBlue® Single Wall Female Extended <i>spigot</i>	33
Accessories	34-35
Chamber and Sump Entry Boots	34
Machines.....	34
Pipe Tools.....	35
Leak Detection System by Andel Limited	36
Electrofusion Jointing Introduction	36
Pipe Preparation Instructions	37-42
Single Wall-Primary Pipe	37-38
Close-Fit	39-40
Pipe-In-Pipe.....	41-42
Single Wall Jointing Guide	43-44
Secondary Containment Jointing Fittings Introduction	45
Close-Fit Jointing Guide	46-48
Pipe-In-Pipe Jointing Guide	49-51
Installation Guide	52-54
Pressure Testing Guide	55
Application Specific Installation Overview	56-61
General Information	62
PLX System Warranty	63
Durapipe UK Pipework Systems	64
Industrial	
Building Services	
Conditions of Sale	67

About Durapipe PLX

Durapipe PLX: A high performance multi-layered polyethylene composite pipe system, supplied in single wall and secondary containment product ranges for various fuelling applications in retail, commercial and industrial markets. Fusion welded for the greatest joint integrity PLX is a specialist range of pipe and fittings specifically designed for the safe transfer of fuel-based liquids and their vapour in pumped or vacuum applications.

The PLX range is comprised of three systems, Single Wall, Secondary Contained Close-Fit and Pipe-In-Pipe.

Single Wall – size ranges 32-160mm for below ground applications.

Close-Fit – size ranges 32#40, 50#63, and 63#75mm for below ground applications.

Pipe-In-Pipe – size ranges 32#63, 50#90, 63#110, 90#160, 110#160mm for specific above and below ground applications.

Pressure Rating

PLX Primary pipework has a maximum pressure rating of 10bar at 20°C.

Durapipe PLX Secondary pipework has a maximum pressure rating of 4bar at 20°C.

Primary Pipe sizes up to 315mm are available on request.

PLX offers tremendous advantages over traditional materials;

- Single Wall and Secondary Contained systems available
- Safe and Durable (30 year design life)
- High Performance 10bar primary pipes
- Corrosion Resistant
- Maintenance Free
- Resists permeation
- Quick, Clean and Easy Electrofusion Joining and Installation
- Dedicated range of matched fittings
- Dimensional stability
- Strong and robust
- UV Resistant
- Full range of accessories and jointing tools
- Allows for interstitial monitoring and environmental protection

Secondary Containment

Fuel industry guidelines are making it mandatory that pressurised (including gravity head) below ground fuel lines are secondary contained or installed in a bunded area.

PLX Secondary Contained 'Close-Fit' and 'Pipe-In-Pipe' systems provide security against accidental fuel losses whilst providing an opportunity for continuous interstitial monitoring and environmental protection in both below ground and above ground applications.



PLX Fittings Range

The PLX system comprises of a wide range of Single Wall and Secondary Contained Electrofusion (EF), Spigot and combined EF#Spigot fittings in couplers, elbows, tees and closures. The jointing of PLX systems by means of electrofusion offers a permanent, rapid and convenient method of creating leak-free joints. **For full jointing instructions please go to page 37.**

PLX electrofusion fittings are designed to work on a fixed fusion time for environmental temperatures between -5°C and +23°C. Fusion cycle temperature compensation times must be applied at temperatures below -5°C and above 23°C.

When using a manual input Electrofusion Control Unit (ECU) the variant compensation time needs to be added/subtracted appropriately.



Transition Fittings

Reliable connections to steel components is vital in most plastic pipe systems and none more so than in fuel applications. PLX transitions combine the benefits of steel and plastics to ensure their design is resistant to end load and bending forces. Available in either spigot or electrofusion format PLX transition fittings have been innovatively designed to suit their intended application and provide ease of installation. Manufactured using the highest-grade materials, transition fittings are available in single wall and secondary contained format.



Chemical Resistance

Durapipe PLX has a highly visible bore that ensures negligible permeation, low absorption and dimensional stability whilst providing excellent chemical resistance to the Volatile Organic Compounds (VOCs) of fuels including petrol, diesels, fuel oils and biofuels. PLX systems are suitable for the distribution of DEF (Diesel Exhaust Fluid) systems such as AdBlue®

Corrosion Resistance

Corrosion resistant, the bonded composite structure of PLX combines the properties of polyethylene and the protective barrier layer. Both are renowned for their resistance to chemical attack, and in service will not rot, rust, pit or corrode, or support the growth of algae, bacteria or fungi. Either buried or above ground, PLX systems are maintenance free.

The pipe's smooth lined bore offers low friction and minimum resistance to flow. Corrosion resistant transition fittings are available in Zinc plated mild steel and stainless steel.



UV Resistance

Pigmented with Carbon black, PLX secondary contained 'Pipe-In-Pipe' systems, have excellent resistance to UV light. Even under the most severe conditions the secondary pipe will retain most of its mechanical and physical properties and will wholly protect the primary pipe. The pressure rating and 30 year design life is unaffected by exposure to sunlight.



Abuse Resistance

PLX is an extremely ductile product that has exceptional resistance to abrasion, mechanical and physical abuse. Its strength and ductility will accommodate occasional pressure surges of up to twice the pipes pressure rating.



Pre-Insulated

With the growth in use of bio-diesel it's important to protect pipe contents from 'waxing' at low temperatures. This is especially important in fuel systems that may be quiescent for long periods eg. generators for UPS systems.

Depending on the bio-diesel feedstock oil, 'waxing' can begin to occur between temperatures of +16°C and -10°C. Polyethylene is a good insulator and PLX 'Pipe-In-Pipe' systems provide short term protection. In exposed fuel systems conveying bio-diesel the PLX pre-insulated 'Pipe-In-Pipe' system should be considered in conjunction with a fuel re-circulation system.

As PLX is a unique system, by ensuring the primary pipe is welded independently from the secondary pipe, Trace Heating systems could also be applied.

Abrasion Resistance

Polyethylene has excellent abrasion resistance. During installation, the abrasive particles of typical soils and backfills do not reduce the design life or pressure rating of the system.

Note: In the unlikely event of a notch or groove being cut into the external surface by more than 10 per cent of the wall thickness, the pipe section should be rejected.

Low Installed Life Costs

The ease of handling and speed of jointing of PLX will generally result in the total installed cost being lower than for threaded or welded metal systems. Pipework installation can be completed in less time than for metal systems. As the installation of PLX is not classed as 'hot works' it can be safely undertaken in most environments.

Environment and Conservation

The manufacture of thermoplastic pipework consumes less energy than the manufacture of equivalent traditional materials. Furthermore, the extrusion and moulding processes are clean and do not produce harmful emissions. A further benefit is that thermoplastic manufacturing scrap can be reprocessed and used for the manufacture of other, non-PLX products.

PLX pipe and fittings are lighter in weight than equivalent metal pipes and fittings and so less fuel is used to transport them.

PLX secondary contained fuel pipe systems protect the environment against the consequences of accidental losses.

Quality and Environment

Durapipe UK's commitment to quality is reflected by our operation of an independently assessed quality management system registered under BS EN ISO 9001.

We also operate an environmental management system that has been successfully assessed against the BS EN ISO 14001 environmental management standard.

Dimensions and Standards

PLX products are made in accordance with the following Standards:

Pipe DIN 8074, 8075, OFTEC, EI, UL971v1, IPv1
Fittings BS EN 1555, OFTEC, AREL (Transitions), EI, UL971v1

Threaded transition fittings conform to the nominal requirements of BS 21/DIN 2999/ISO 7 specifications. Male and Female threads are tapered.

Flanged drillings conform to the nominal requirements of BS4504, DIN2501 Table 10 and Table 16.

Materials

Durapipe PLX pipe and fittings range is a polyethylene based system with PLX pipe having additional features and benefits of a bonded composite structure. PLX has a protective barrier layer, offering a smooth bore that ensures negligible permeation.



Polyethylene

All products are made from virgin polyethylene.

Polyethylene is a thermoplastic belonging to the material group of polyolefins.

Polyethylene offers numerous features and benefits over traditional materials that include:

Features

- Mechanical strength
- Chemical resistance
- Carbon black properties
- Electrofusion jointing

Benefits

- Ductile and durable
- Does not rot, rust, pit or corrode
- UV / weathering resistance
- Leak tight assembly

Protective Barrier Layer

All primary pipes are co-extruded and have a lined bore surface. The protective barrier layer has similar mechanical and physical properties to polyethylene. Bonding these materials together offers numerous benefits over unlined pipe:

Features

- Smooth bore
- Clearly visible bore layer
- Chemical resistance

Benefits

- Does not support bacteria and algae growth
- Minimises frictional head losses
- Continuous flow rate
- Resists permeation of VOCs

PLX Primary Pipe

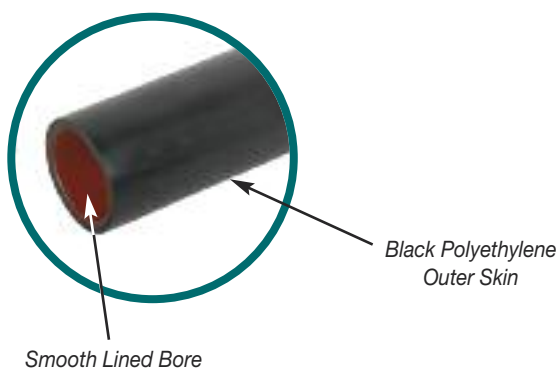

Polyethylene

Property	Method of Test	Units	PE80 (MDPE)	PE100 (HDPE)
Melt flow rate - 2.16kg load	BS2782	g/10min	0.2	<0.15
	ISO 1133			
5kg load	BS2782	g/10min	1.0	<0.5
	ISO 1133			
Density (Mean Values)	BS3412 ISO 1872	kg/m ³	950	957
Tensile strength at yield	BS2782 ISO R527	MPa	18	23
Elongation at break	BS2782 ISO R527	%	>600	>600
Flexural Modulus	BS2782 ISO R527	MPa	700	1000
Vicat softening point	BS2782	°C	116	124
Brittleness temperature	ASTM D746 ISO 9784	°C	<-70	<-100
Linear thermal expansion	ASTM D696	°C	1.5 x 10 ⁻⁴	1.3 x 10 ⁻⁴
Thermal conductivity	BS874 DIN 52612	W/m ² K	0.4	0.4



Introduction and Manufacturing Process

Durapipe PLX pipe is a composite material manufactured by a state of the art co-extrusion process. The pipe consists of an outer pressure bearing layer of polyethylene material, and an inner bore layer which provides the fuel barrier. All of the raw materials used for PLX production are virgin polymers and subjected to rigorous quality control tests.

Finished pipe is subjected to quality control tests dictated by the product specification and industry standard, these include mechanical properties, thermal stability, pressure resistance, low temperature impact resistance and inter-layer bond strength.



The tough outer layer of Polyethylene provides excellent resistance to abrasion, mechanical and physical abuse and is corrosion and maintenance free. The highly visible molecularly bonded liner completes the composite pipe structure ensuring negligible permeation, low absorption and dimensional stability. Impermeable to diesel, fuel oils and their vapours, PLX exceeds the requirements of international standards and provides complete protection against fuel losses.



Secondary Contained Pipes

Additional security against accidental fuel losses is achieved by using PLX Secondary Containment pipe systems. PLX exceeds the industry requirements regarding secondary containment of pressurised fuel delivery systems and provides an opportunity for continuous interstitial monitoring.

Single Wall Pipe

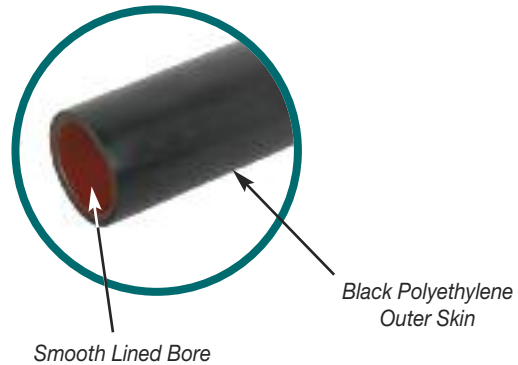

Close-Fit

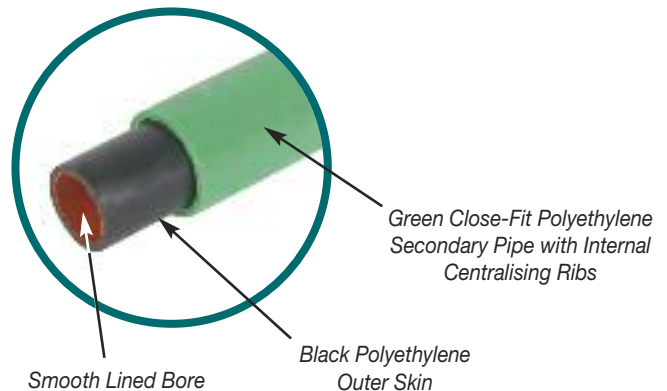

Pipe-In-Pipe

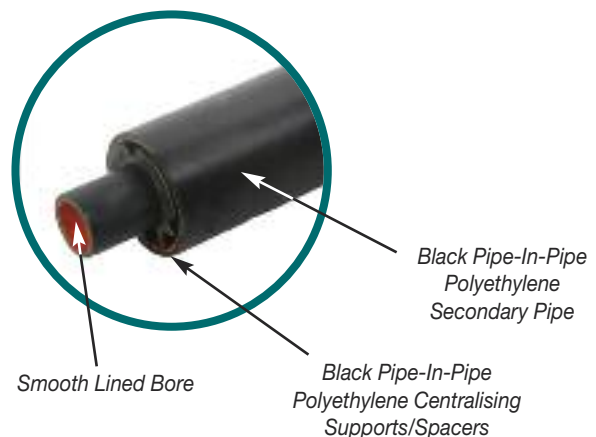

Durapipe PLX Product Specifications



PLX Single Wall - Used for below ground suction systems and available in straight lengths or coils.



PLX Close-Fit - Used for below ground sections of the system and available in straight lengths or coils.



PLX Pipe-In-Pipe - Used for specific above and below ground fuel transfer applications.

Chemical Resistance of PLX

Petrol and diesel fuels are produced in oil refineries using a distillation process. The virgin fuels separated from crude oil during this process do not, on their own, meet the required specifications for combustion or emissions for modern engines (in particular octane rating) and so are blended with a series of other hydrocarbons Volatile Organic Compounds (VOCs) and performance additives to create the required properties.

With ever increasing global demands on finite fossil fuel deposits the global market is looking for substitutes in the form of biofuels produced from a variety of feed stocks and used as a complete substitute or blended.

The highly visible bonded lining and composite pipe structure ensures negligible permeation, low absorption and dimensional stability. PLX is impermeable to the following liquid fuels and their vapour:

- Petrol
- Diesel
- Civil and military grade aviation fuels such as A1
- Rapeseed oil
- Kerosene
- **E10** (petrol with 10% ethanol)
- **E20** (Gasoline with 20% ethanol)
- **E85** (Gasoline with 85% ethanol)
- **E100** (Pure ethanol)
- **B5** (Diesel with up to 5% biodiesel)
- **B20** (Diesel with up to 20% biodiesel)
- **B100** (Pure biodiesel)

Standard Dimensional Ratio (SDR)

One of the items of information contained on both pipe and fittings is the Standard Dimensional Ratio, ie. the ratio between wall thickness and outside diameter.

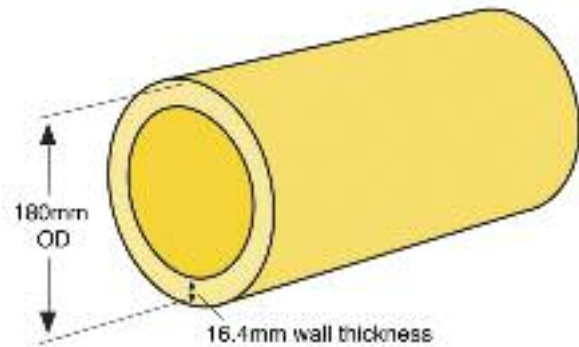

Pressure and Flow Ratings

PLX Primary pipe has a maximum pressure rating of 10bar at 20°C.

PLX Secondary pipe has a maximum pressure rating of 4bar at 20°C.

The smooth protective barrier layer of PLX offers a negligible resistance to flow and will not corrode or support algae growth or deteriorate with use. PLX will maximise flow rates with greater pump efficiency and minimal operating cost. PLX Fill & Vent (SDR17) improves the filling times of Underground Storage Tanks (USTs) and lessens the chance of tank pressurisation and over filling.

Flow Nomogram

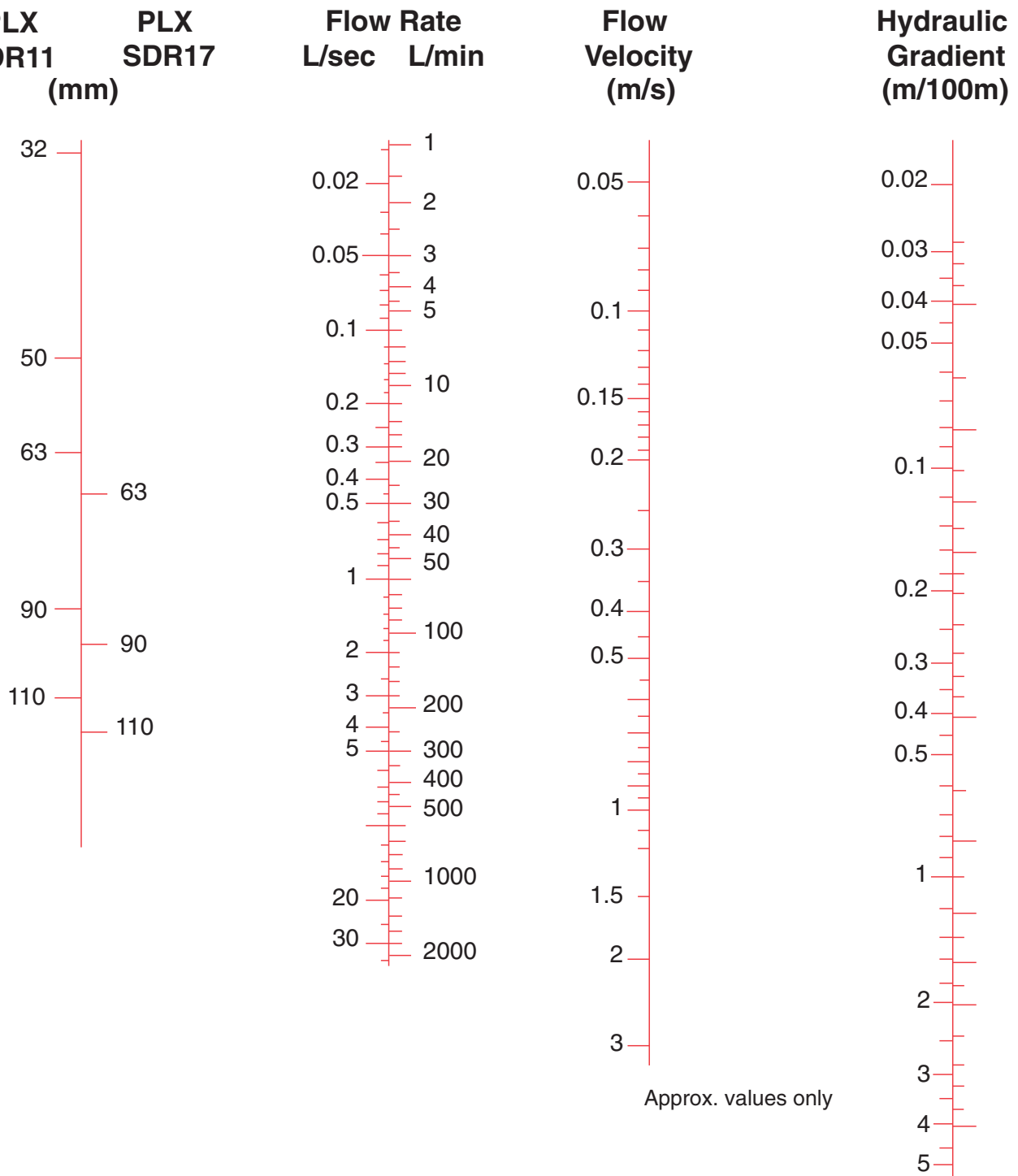

Durapipe PLX Electrofusion and Spigot Fittings

The PLX system comprises of a wide range of Single Wall and Secondary Contained Spigot and Electrofusion fittings - couplers, elbows, tees and closures. The jointing of PLX pipes through electrofusion offers a permanent, rapid and convenient method of pipe joining.

This advanced innovative manufacturing technique of all fittings ensures:

- Deep electrofusion sockets for maximum joint strength on primary pipes
- Gap filling fusion joint process
- 39.5V Operation
- The heating coils are placed as close to the joint surfaces as possible
- Wire position accurately controlled during manufacture and the fusion process
- Uniform heat distribution during the electrofusion process
- Melt pressure and temperature are both accurately controlled
- Heating coils are protected from damage during installation
- Barcoded containing size and fusion and cooling times
- Fusion indicators
- Mushroom caps - used after the cooling process for insulating the fusion terminals

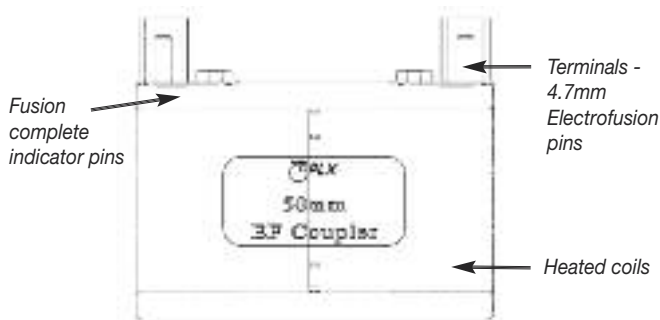

All PLX electrofusion fittings employ the same basic principle. The socket of the fitting incorporates an electrical heating coil. An electrofusion control unit (ECU) regulates and supplies the power necessary to energise and heat the coil. When the coil is energised the immediate pipe and fitting surfaces melt to form an expanding pressurised pool of molten material. The continued introduction of heat energy causes the expanding pool of molten material to mix under the melt pressure, forming a homogenous mass that is vital in producing a good weld. Following the termination of the heat cycle, the fitting and pipe are left to cool allowing the melted material to solidify to form a joint that is stronger than the pipe.

Using PLX EF fittings, consistent, reproducible, high integrity joints will be achieved if:

- Pipe and fittings preparation instructions are followed (see page 37)
- Pipe and fittings assembly instructions are followed (see page 43)

This will ensure that the installed PLX systems are wholly secure with leak tight joints.

Electrofusion Principles

Hot and cold zones, sometimes called melt and freeze zones, are formed after energising the coil. The cold zones ensure that molten material is locked in place and that a melt pressure is created and controlled throughout the jointing process. The precisely controlled pitch and positioning of the heating coil in relation to the inner surface of the socket ensures uniform heat distribution.

PLX electrofusion fittings are designed for use with 39.5 volt output Electrofusion Control Units.

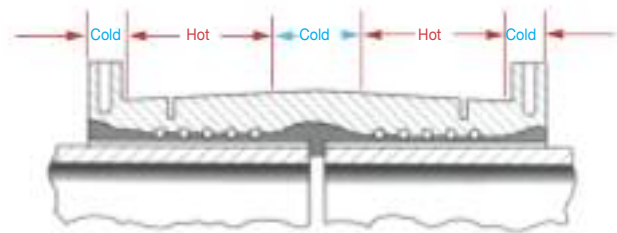

The Fusion sequence

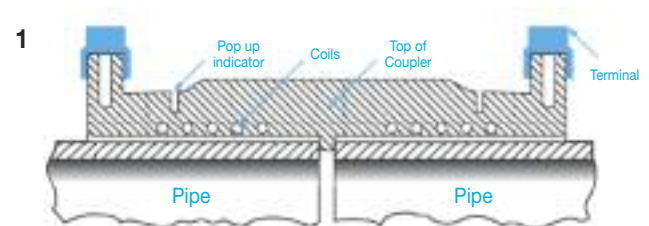

Pipe positioned in coupler prior to energising coil.



Coil energised.

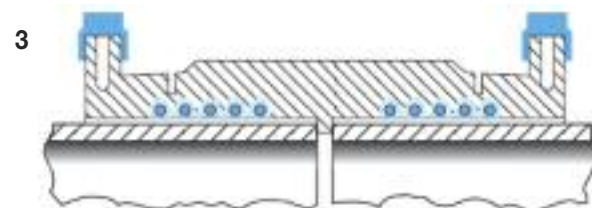

Material surrounding coils starts to melt.

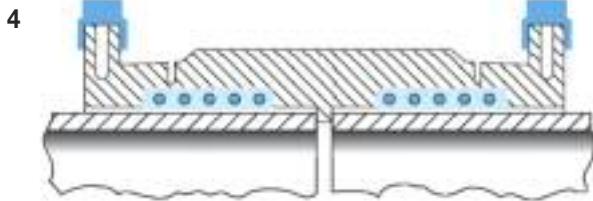

Area of melt extends leading to expansion towards pipe surface.

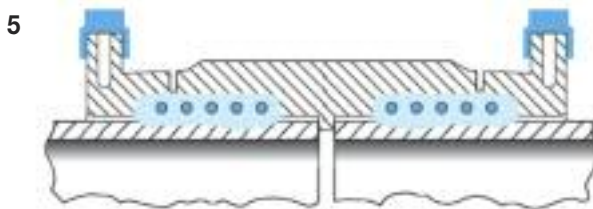

Heat transfers to pipe wall and pipe material starts to melt.

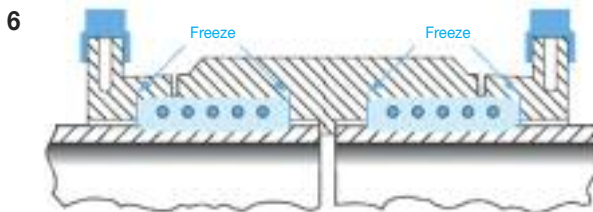

Melt solidifies at the start of the cold zones, thereby sealing the melt zone. Further input of energy causes increase in melt pressure.

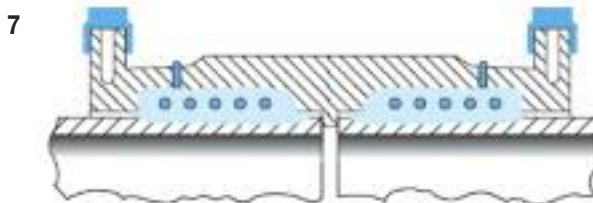

Melt pressure reaches optimum value at end of energising cycle. Emergence of the melt at the indicator holes shows that fusion is complete.

PLX Barcode Introduction

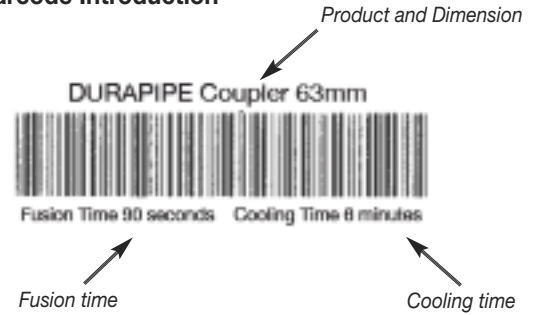

Technology is now available which eliminates the need to enter the fusion time manually. Electrofusion control units (ECUs) can be supplied with the ability to read a barcode where fixed to an electrofusion fitting. These machines have a 'light pen' attached, which the operator uses to input the data by scanning the barcode. Barcode or automatic control units also have data logging facilities that provide traceability of site welding parameters. An output socket on the ECU allows downloading of this information onto a computer database or printer to give a complete Quality Check (QC) record of the joints which have been made. This information can be downloaded daily, or upon completion of the project. The units will store up to 200 operations. The ECU barcode will display a description of the fitting, which includes three digits to denote size, and this should be read and checked by the operator before proceeding.

Temperature/Fusion Time Compensation

Durapipe PLX electrofusion fittings are designed to work on a fixed fusion time in ambient temperatures between -5°C and +23°C. For further details on fusion time compensation please contact Durapipe Technical Support.



PLX Secondary Contained Electrofusion#Short Spigot (EF#SS) Fittings

Durapipe PLX Secondary Contained Fittings are designed to ensure that the primary and secondary pipe systems function independently. Each of the Secondary Contained Electrofusion fittings are supplied with a primary electrofusion fitting inside an outer spigot fitting allowing the primary pipe to be fusion welded independently of the secondary system. The standard terminal shrouds and pins of the primary pipe are replaced at the factory with extended wire leads which allow for the safe weld to take place. Once fusion is complete they serve no further purpose and can be removed. 'Spring loaded' Terminal adaptor pins (Code 43 EWO 004) are used to provide the connection between the EF fitting 'flying leads' and the ECU 4.7mm pin output leads.

The pipe and fitting interstice is fully sealed by fusing the secondary spigot fittings to the secondary pipes by using either slip closures or short pattern PLX Secondary electrofusion couplers.



PLX Transition Fittings

PLX Transition fittings ensure the safe continuous flow of fuel when connecting to and from pumps, tanks and other metal threaded and flanged connections. Transition fittings are manufactured using the highest quality materials. With the ease of installation and system integrity paramount, the fittings have been designed to save time and costs during the installation process.

Compact and easy to fit the deep sockets of the electrofusion transition fittings give greater control of the jointing cycle while the smooth bore of the extended Single Wall and Secondary Contained Spigot fittings ensures there is minimal affect on the flow of fuel through PLX connections. The design of the Secondary Containment extended spigot fittings ensures the complete system is secondary contained and the interstice can be pressure tested and monitored.



PLX Pipe End Closures and Interstitial Access Points

PLX Electrofusion pipe closures seal the secondary to the primary pipe and allow the interstice to be initially and periodically pressure tested and permanently monitored.

On remote or unattended installations leak detection systems can be installed to continuously monitor for accidental losses and system damage.

Environmental monitoring systems can be designed for use with either liquid detection, over-pressure or under-pressure operation and fitted with a variety of audible alarms and warning devices and safely linked to active fail safe valves or interface with the Building Management systems (BMS).

Multi-port manifolds are used to group and simultaneously monitor a number of fuel lines.

PLX Access tees and saddles have been designed with monitoring and leak detection in mind ensuring that the installation is as convenient as possible.

See page 36 for details on the Andel leak detection system.



Durapipe PLX Product Innovations

The Durapipe PLX product range has developed over the years producing many product innovations that are dedicated to reducing costs and installation times. These products have been specifically designed for fuel related installations and applications.

Innovations include:

PLX Close-Fit Unique 32#40mm Transition Fitting

Three Fittings in one!

A unique 1" BSP Female Stainless Steel 32#40mm electrofusion transition fitting adds to our vast range of fittings. There are no other transition fittings in the market place manufactured with the same precision and engineering that make this essential for your application. When time is a factor, during installation, a reduction in fittings can be extremely beneficial to the installer. This fitting has three main features:

- Secure transition from PE to metal
- Closure of the 32mm and 40mm secondary contained Close-Fit pipe system
- Access port for interstitial monitoring and periodic testing



PLX Close-Fit Extended Transitions

PLX Extended Transitions have been specifically designed ensuring a Close-Fit installation is securely secondary contained throughout. The range consists of Female, Male and Flanged BS4504, and available in sizes to suit the PLX Close-Fit system range. They have been designed to reduce the number of welds needed within tight spaces.

- All fittings are double spigot and complete with 1/8" access port
- Extended pipe length is 750mm
- Sizes available 50#63 and 63#75mm
- Safe and secure transition from PE to metal



PLX Secondary Containment Electrofusion Couplers

A range of 39.5V Compact electrofusion secondary couplers are now available for welding PLX secondary pipes (Pipe-In-Pipe) and their matched spigot fittings, meaning that one ECU machine can be used onsite for welding all Electrofusion fittings in the PLX range.

Key features include:

- Compact design
- No internal pipe stops, making installation of Pipe-In-Pipe systems easier
- 39.5V operation
- Jointed using the standard manual or automatic ECU
- greater integrity and cost saving



PLX In-Line Anchor Fittings

These unique ranges of PLX Pipe-In-Pipe fittings have several roles in secondary contained systems.

This range of double spigot fittings are supplied with either a solid annular design or with drilled communication ports.

When installed in long runs of pipework, the PLX In-Line Anchor helps to control or negate the differential thermal movement caused by changes in the pipe system's ambient or content temperatures.

The anchors should be strategically placed, such that the systems natural flexibility is used to accommodate the direction and magnitude of any thermal movement.

The solid PLX In-Line Anchors are used to divide the interstice into compartments (zones) that can be individually monitored. In the unlikely event of a leak, the individually zoned system can be more easily investigated to identify the location of the problem.

Drilled PLX In-Line Anchors provide full support between the primary and secondary pipe and can be installed in either horizontal or vertical pipe systems.

Key features of PLX In-Line Anchors include:

- Double spigot ended
- To create a positive link between the primary and secondary pipe to ensure that neither pipe can act independently of the other
- In vertical pipe systems the positive link between primary and secondary pipes ensures that the whole system is fully supported
- In standard systems the 'undrilled' solid In-Line Anchors create separate interstitial compartments that can be independently monitored
- Can be used to separate the interstice of 'Pipe-In-Pipe' systems



PLX Large Diameter Tees

Providing similar characteristics as the Durapipe PLX In-Line Anchors, they create compact but equal reduced branch and flanged branch connections. The tee is supplied with drilled communication ports for continuity of the interstice.

- Designed to create compact, equal and reduced branch connections for secondary contained PLX Pipe-In-Pipe system connections
- Continuity of the interstice and permanent monitoring systems
- Can be buried or used above ground in ducted pipe systems
- Offers strength at a crucial point of the installation



Index to PLX products

Pipe



Single Wall Pipe
Page 20



Secondary Contained -
Close-Fit
Page 21



Secondary Contained -
Pipe-In-Pipe
Page 21



Secondary Contained -
Close-Fit - Hockey-stick
Bend
Page 21



AdBlue® - Straights PE
Unlined Pipe
Page 21

Electrofusion



Single Wall Primary Pipe
Coupler
Page 22



Single Wall Primary
45° Elbow
Page 22



Single Wall Primary
90° Elbow
Page 22



Single Wall Primary
Equal Tee
Page 23



Single Wall Primary
Reducer
Page 23



Single Wall Primary
End Cap
Page 23



Secondary Contained
Primary Coupler with
Leads
Page 24



Secondary Contained
Close-Fit Pipe Joiners
Page 24



Secondary Couplers
Page 24



Secondary Contained
Reducers - Pipe-In-Pipe
Page 24



Secondary Contained
Reducers - Close-Fit
Page 25



Secondary Contained
45° Elbows
Page 25



Secondary Contained
90° Elbows
Page 25



Secondary Contained
90° Elbows - Spigot
Page 25



Secondary Contained
Equal Tee
Page 25-26



Secondary Contained
Reduced Branch Tee
Page 26



Secondary Contained
Slip Closures
Page 26-27



Secondary Contained
Access Tees
Page 27



Secondary Contained
Interstitial Access Saddles
Page 27

Index to PLX products

Transitions



Single Wall Female
Page 28



Single Wall Male
Page 28



Single Wall Female -
Compact Flange
Page 28



Single Wall Female - bsp
Page 28



Single Wall Male - bsp
Page 29



Single Wall Female
Compact Flange - bsp
Page 29



Single Wall Female
Extended - bsp
Page 29



Single Wall Male
Extended - bsp
Page 29



Single Wall Female
Compact Flange
Extended - bsp
Page 30



Secondary Contained -
Close-Fit Female
Extended - bsp
Page 30



Secondary Contained -
Close-Fit Male Extended
Page 30



Secondary Contained -
Close-Fit Compact
Flange Extended
Page 30



Secondary Contained -
Close-Fit Female - bsp
Page 31



Stub Flange Assembly
Page 31



Secondary Contained
In-line Anchor
Page 31



Secondary Contained
Drilled Flange Assembly
Page 32



Secondary Contained
Female - bsp
Page 32



Secondary Contained
Male - bsp
Page 32



Secondary Contained
Female Compact
Flange - bsp
Page 32



Secondary Contained
Elbow 90° Flanged (PE)
Page 32



Secondary Contained
Elbow 90° Female
Page 33



Secondary Contained
Reduced Branch
Flanged Tee
Page 33



Stage 2 Vapour Recovery
Manifold
Page 33



AdBlue® Single Wall
Male Extended - bsp
Page 33



AdBlue® Single Wall
Female Extended - bsp
Page 33

Accessories



Chamber and Sump
Entry Boots
Page 34



Machines
Page 34



Pipe Tools
Page 35

Introduction to Application Check - APP CHECK

On pages 20 and 21 there are references to Application Check - **APP CHECK**. These are there to ensure you are selecting the correct product for your application needs. Each application is colour coded to make it easier to identify your product needs. The key to **APP CHECK** is as follows:



FORECOURT APPLICATION ONLY
These products must only be used in Forecourt applications.



FORECOURT & POWER SUPPLY
These products can be used for Forecourt and Power Supply applications.



POWER SUPPLY APPLICATION ONLY
These products can be used in Power Supply applications.



POWER SUPPLY & TRANSPORT REFUELLING
These products can be used for Power Supply and Transport Refuelling applications.



TRANSPORT REFUELLING APPLICATION ONLY
These products can be used in Transport Refuelling applications.



ALL APPLICATIONS
These products can be used for all applications.

Our Markets

Forecourts



Car, lorry, bus owners need for fuel to be easily accessible, making the forecourt critical to daily life. Ensuring that the fuel is transferred safely, underground from tanks to the pumps for commercial access, choosing a high performance pipe system is a key element in the process.

Applications

- Pressure Systems
- Suction Systems
- Offset Fill
- Vents
- Stage 1 and 2 Vapour Recovery
- Tank Chamber Connection
- Sump & Pump Connection

Durapipe UK has produced fuel pipe systems for this market for over 16 years, so have experience of manufacturing high quality product for all applications within this market. PLX was originally designed for the safe transfer of fuel for this market and has been installed in thousands of stations around the world during this time.

Products

- Single Wall
- Secondary Containment Close-Fit
- Secondary Containment Pipe-In-Pipe
- AdBlue®

Case Studies

“The quality and performance of Durapipe PLX products, combined with the service from the technical and support team, has always been exceptional and key to our successful relationship. “We initially chose to utilise Durapipe UK as our pipework supplier for its forward thinking when it comes to product development – something that we continue to be impressed by.”

Tom Hocking
Operations Director at
D. Berry and Co. Ltd



“We were particularly impressed with how quick and straightforward the installation of the pipework was, which is not often something that can be said about pipework systems. The product was of the highest quality and as a result we are installing it within the six other forecourts we are currently constructing.”

Tuten Aluc
Business Development
Manager of Interpet, Turkey





Power Supply

With an increased reliance on electronic systems in everyday life, sudden and prolonged loss of power supplies can endanger lives and disrupt business services and commerce. Oil powered emergency and uninterrupted power supplies (UPS) safeguard against this scenario but they need to be instant and reliable. Underpinning this is the need for a high performance pipe system.

Applications

- Uninterrupted Power Supply
- Emergency Power Supply
- Heat and Power Supply

Durapipe PLX is a high performance fusion welded secondary containment pipework system specifically designed to meet this need, conveying fuel oil to generators and boilers in absolute safety.

Products

- Secondary Containment Close-Fit
- Secondary Containment Pipe-In-Pipe

Case Studies

Kingsway Hospital, Derby

"The fact that the PLX range incorporates a comprehensive selection of transition fittings was ideal for us as we needed to be able to easily connect the pipework to the oil tank and the boiler."

Ian Murray

Engineering Services (Humber)



Gartnavel Royal Hospital, Glasgow

"We specified Durapipe PLX pipework as it presented a reliable system that would perform well against corrosion. Additionally, it proved extremely easy to handle and install on site."

Hughie McRobbie

Northern Business Development Manager of Progress Group



Transport Refuelling

All modes of transport require fuel to enable them to function as required. Marinas, airports, rail, haulage depots all need fuel to economise and perform. Large diameter specialist pipe systems are required to meet the needs of bulk refuelling for large main depots housing these types of transport vehicles.

Applications

- Marinas
- Aviation
- Rail
- Haulage/Central Distribution areas
- Tunnels (drainage)

Durapipe PLX has been installed within numerous large transport depot projects throughout the world. From a Marina in Papagayo, Costa Rica, a major redevelopment of navel base HMAS Cairns in Queensland to large construction specifically built as part of the 2008 Olympic games - The Olympic Qingdao International Sailing Centre.

Products

- Secondary Containment Close-Fit
- Secondary Containment Pipe-In-Pipe
- Single Wall - Drainage purposes

Case Studies

Sugar Wharf HMAS Cairns in Queensland

Over 1,500 metres of 110mm and 160mm secondary contained Durapipe PLX pipework and fittings has been installed as part of a major redevelopment of the naval base HMAS Cairns in Queensland, Australia. As part of the redevelopment, the fuel lines needed updating to meet the higher standards demanded by the new facility.



Qingdao International Sailing Centre

More than 2,000 metres of PLX was installed as part of the construction of the Olympic Qingdao International Sailing centre in 2008. PLX was installed in the newly built service station used to refuel the sailing boats competing in the Olympic games. PLX Secondary Contained pipework was installed underground starting at the service station for cars and finishing at the harbour wall for boats.



PLX Pipe Systems



Features

- Polyethylene composite material
- Protective barrier co-extruded bore layer
- Polyethylene black outer skin
- Secondary Containment
- Fusion welded system
- Available in Straights and Coils

Benefits

- Safe and durable (30 year design life)
- Resists permeation and anti-clogging properties
- UV resistant
- Allows for interstitial monitoring and leak detection
- Fast, simple jointing
- Easy installation and minimal jointing



Single Wall Pipe SDR11 – Straights

Size OD mm	PN bar	Minimum Thickness mm	Length m	Code
32	10	3.0	6	43 626 308
50	10	4.6	6	43 626 310
63	10	5.8	6	43 626 311
90	10	8.2	6	43 626 313
110	10	10.0	6	43 626 314
160	10	9.5	6	43 626 317



Single Wall Pipe SDR11 – Coils

Size OD mm	PN bar	Minimum Thickness mm	Coil Bore (id) m	Coil Dia (d) m	Width (w) m	Length m	Code
32	10	3.0	1.1	1.4	0.15	50	43 614 308
50	10	4.6	1.3	1.7	0.15	50	43 614 310
63	10	5.8	1.3	1.8	0.19	50	43 614 311
32	10	3.0	1.1	1.4	0.27	100	43 615 308
50	10	4.6	1.3	1.8	0.22	100	43 615 310
63	10	5.8	1.3	1.9	0.28	100	43 615 311



Gravity Fill & Vent SDR17 – Straights

Size OD mm	Minimum Thickness mm	Length m	Code
63	3.9	6	43 609 311
90	5.7	6	43 609 313
110	7.0	6	43 609 314



For further information on the colour coded application key, please see Application Check on pages 18-19.



Secondary Contained – Close-Fit – Straights				
Size OD mm	PN bar	Minimum Thickness mm	Length m	Code
32#40	10	6.5	6	43 664 413
50#63	10	8.1	6	43 664 444
63#75	10	9.7	6	43 664 445



Secondary Contained – Close-Fit – Coils							
Size OD mm	PN bar	Minimum Thickness mm	Coil Bore (id) m	Coil Dia (d) m	Width (w) m	Length m	Code
32#40	10	6.5	1.1	1.5	0.17	50	43 624 413
50#63	10	8.1	1.35	1.8	0.26	50	43 624 444
63#75	10	9.7	1.3	1.7	0.4	50	43 624 445
32#40	10	6.5	1.1	1.5	0.25	100	43 649 413
50#63	10	8.1	1.35	2	0.32	100	43 649 444
63#75	10	9.7	1.3	2.1	0.42	100	43 649 445



Secondary Contained – Pipe-In-Pipe – Straights					
Size OD mm	PN bar	Minimum Thickness Primary mm	Minimum Thickness Secondary mm	Length m	Code
32#63	10	3.0	3.7	6	43 601 308
50#90	10	4.6	5.3	6	43 601 310
63#110	10	5.8	6.5	6	43 601 311
90#160	10	8.2	9.5	6	43 601 313
110#160	10	10.0	9.5	6	43 601 314



Secondary Contained – Close-Fit – Hockey Stick Bend				
Size OD mm	PN bar	Minimum Thickness mm	Length m	Code
32#40	10	6.5	-	43 338 308



AdBlue® – Straights PE Unlined Pipe				
Size OD mm	PN bar	Minimum Thickness mm	Length m	Code
50	10	4.1	6	43 513 310
63	10	5.3	6	43 513 311
50	10	4.1	50	43 559 310
63	10	5.3	50	43 559 311
50	10	4.1	100	43 560 310
63	10	5.3	100	43 560 311



***For coil dimensions see Single Wall Pipe SDR11 - Coils

PLX Electrofusion/Spigot Fittings



Features

- Fusion welded system
- 39.5V sockets
- Secondary Contained fittings
- Heating coils are as close to the joint surface as possible

Benefits

- Fast, simple jointing
- Standard electrofusion voltage
- Ensuring welding of Primary independently to the Secondary pipe
- Leak tight joints



Single Wall Primary Coupler

Electrofusion

Size OD mm	PN bar	Description	Code
32	10	39.5V	43 100 308
50	10	39.5V	43 100 310
63	10	39.5V	43 100 311
90	10	39.5V	43 100 313
110	10	39.5V	43 100 314
160	10	39.5V	43 100 317



Single Wall Primary 45° Elbow

Electrofusion

Size OD mm	PN bar	Description	Code
32	10	39.5V	43 105 308
50	10	39.5V	43 105 310
63	10	39.5V	43 105 311
90	10	39.5V	43 105 313
110	10	39.5V	43 105 314
160	10	39.5V	43 105 317



Single Wall Primary 90° Elbow

Electrofusion

Size OD mm	PN bar	Description	Code
32	10	39.5V	43 104 308
50	10	39.5V	43 104 310
63	10	39.5V	43 104 311
90	10	39.5V	43 104 313
110	10	39.5V	43 104 314
160	10	39.5V	43 104 317



Single Wall Primary Equal Tee (Spigot branch)			
Electrofusion			
Size OD mm	PN bar	Description	Code
32	10	39.5V	43 408 308
50	10	39.5V	43 408 310
63	10	39.5V	43 408 311
90	10	39.5V	43 408 313
110	10	39.5V	43 408 314
160	10	39.5V	43 408 317



Single Wall Primary Reducer			
Electrofusion			
Size OD mm	PN bar	Description	Code
32 x 50	10	39.5V	43 402 414
32 x 63	10	39.5V	43 402 415
50 x 63	10	39.5V	43 402 444
63 x 90	10	39.5V	43 402 459
90 x 110	10	39.5V	43 402 483
110 x 160	10	39.5V	43 402 495



Single Wall Primary End Cap			
Electrofusion			
Size OD mm	PN bar	Description	Code
32	10	Spigot	43 233 308
50	10	Spigot	43 233 310
63	10	Spigot	43 233 311
90	10	Spigot	43 234 313
110	10	Spigot	43 234 314



Single Wall Primary End Cap - Gravity Fill & Vent			
Electrofusion			
Size OD mm	PN bar	Description	Code
90	10	Spigot	43 232 313
110	10	Spigot	43 232 314



Secondary Contained Primary Coupler with Leads			
Electrofusion			
Size OD mm	PN bar	Description	Code
32	10	39.5V	43 101 308
50	10	39.5V	43 101 310
63	10	39.5V	43 101 311
90	10	39.5V	43 101 313
110	10	39.5V	43 101 314



Secondary Contained Close-Fit Pipe Joiners			
Electrofusion			
Size OD mm	PN bar	Description	Code
32#40	10	39.5V	43 249 308
50#63	10	39.5V	43 249 310
63#75	10	39.5V	43 249 311



Secondary Couplers			
Electrofusion			
Size OD mm	PN bar	Description	Code
63	10	39.5V	43 110 311
90	10	39.5V	43 110 313
110	10	39.5V	43 110 314
160	10	39.5V	43 110 317

For more information on this product please go to page 13.



Secondary Contained Reducers – Pipe-In-Pipe			
Electrofusion			
Size OD mm	PN bar	Description	Code
32#63 x 50#90	10	39.5V	43 342 308
50#90 x 63#110	10	39.5V	43 342 310
63#110 x 90#160	10	39.5V	43 342 311
90#160 x 110#160	10	39.5V	43 342 313



Secondary Contained Reducers – Close-Fit			
Electrofusion			
Size OD mm	PN bar	Description	Code
32#40 x 50#63	10	39.5V	43 343 308
50#63 x 63#75	10	39.5V	43 343 310



Secondary Contained 45° Elbows			
Electrofusion#Spigot			
Size OD mm	PN bar	Description	Code
32#63	10	39.5V with leads	43 250 308
50#90	10	39.5V with leads	43 250 310
63#110	10	39.5V with leads	43 250 311
90#160	10	39.5V with leads	43 250 313
110#160	10	39.5V with leads	43 250 314



Secondary Contained 90° Elbows			
Electrofusion#Spigot			
Size OD mm	PN bar	Description	Code
32#63	10	39.5V with leads	43 248 308
50#90	10	39.5V with leads	43 248 310
63#110	10	39.5V with leads	43 248 311



Secondary Contained 90° Elbows			
Electrofusion			
Size OD mm	PN bar	Description	Code
90#160	10	Double Spigot	43 346 313
110#160	10	Double Spigot	43 346 314

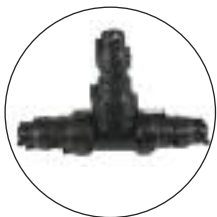

Secondary Contained Equal Tee			
Electrofusion			
Size OD mm	PN bar	Description	Code
32#40	10	39.5V	43 350 308



Secondary Contained Equal Tee			
Electrofusion#Spigot			
Size OD mm	PN bar	Description	Code
32#90	10	39.5V with leads	43 246 308
50#90	10	39.5V with leads	43 246 310
63#110	10	39.5V with leads	43 246 311



Secondary Contained Equal Tee			
Double Spigot			
Size OD mm	PN bar	Description	Code
90#160	10	Double Spigot	43 348 313
110#160	10	Double Spigot	43 348 314



Secondary Contained Reduced Branch Tee			
Double Spigot			
Size OD mm	PN bar	Description	Code
90#160#63#110	10	Double Spigot	43 349 313
110#160#63#110	10	Double Spigot	43 349 314



Secondary Contained Slip Closures			
Electrofusion			
Size OD mm	PN bar	Description	Code
32#40	10	39.5V	43 278 413
40#63	10	39.5V	43 278 430
50#63	10	39.5V	43 278 444
63#75	10	39.5V	43 278 445
63#90	10	39.5V	43 278 459
75#110	10	39.5V	43 278 472



Secondary Contained Slip Closures with 1/8" bsp Access Port			
Electrofusion			
Size OD mm	PN bar	Description	Code
32#40	10	39.5V	43 279 413
40#63	10	39.5V	43 279 430
50#63	10	39.5V	43 279 444
63#75	10	39.5V	43 279 445
63#90	10	39.5V	43 279 459
75#110	10	39.5V	43 279 472



Secondary Contained Access Tee - Short branch - bsp			
Electrofusion			
Size OD mm	PN bar	Description	Code
40mm x 1/2" bsp	10	Short Branch 39.5V	43 351 309



Secondary Contained Access Tee - Long branch - bsp			
Electrofusion			
Size OD mm	PN bar	Description	Code
40mm x 1/2" bsp	10	Long Branch 39.5V	43 352 309



Secondary Contained Interstitial Access Saddle			
Electrofusion#Spigot			
Size OD mm	PN bar	Description	Code
63 x 32	10	39.5V	43 416 415
90 x 32	10	39.5V	43 416 417
110 x 32	10	39.5V	43 416 418
160 x 32	10	39.5V	43 416 421



Secondary Contained Interstitial Access Saddle with 1/8" bsp Access Port			
Electrofusion#Spigot			
Size OD mm	PN bar	Description	Code
63 x 3/8" bsp	10	39.5V	43 354 311
90 x 3/8" bsp	10	39.5V	43 354 313
110 x 3/8" bsp	10	39.5V	43 354 314
160 x 3/8" bsp	10	39.5V	43 354 317

PLX Transition Fittings - Electrofusion/Spigot Fittings



Features

- Fusion welded system
- 39.5V sockets
- Secondary Contained fittings
- Wide range of transition fittings

Benefits

- Fast, simple jointing
- Standard electrofusion voltage
- Ensuring welding of Primary independently to the Secondary pipe
- Simple connection to Tanks, Pumps, Generators and other system apparatus



Single Wall Female – bsp

Electrofusion

Size OD mm	PN bar	Description	Code
32 x 1" bsp	10	39.5V	43 394 308
50 x 1 1/2" bsp	10	39.5V	43 741 310
63 x 1 1/2" bsp	10	39.5V	43 741 628
63 x 2" bsp	10	39.5V	43 741 311



Single Wall Male – bsp

Electrofusion

Size OD mm	PN bar	Description	Code
32 x 1" bsp	10	39.5V	43 395 308
50 x 1 1/2" bsp	10	39.5V	43 743 310
63 x 1 1/2" bsp	10	39.5V	43 743 628
63 x 2" bsp	10	39.5V	43 743 311



Single Wall Female Compact Flange – bsp

Electrofusion

Size OD mm	PN bar	Description	Code
50 x 1 1/2" bsp	10	39.5V	43 742 310
63 x 2" bsp	10	39.5V	43 742 311



Single Wall Female – bsp

Long Spigot

Size OD mm	PN bar	Description	Code
50 x 1 1/2" bsp	10	Long Spigot	43 719 310
63 x 1 1/2" bsp	10	Long Spigot	43 719 628
63 x 2" bsp	10	Long Spigot	43 719 311
90 x 3" bsp	10	Long Spigot	43 483 313
110 x 4" bsp	10	Long Spigot	43 483 314



Single Wall Male - bsp Long Spigot			
Size OD mm	PN bar	Description	Code
50 x 1 1/2" bsp	10	Long Spigot	43 723 310
63 x 1 1/2" bsp	10	Long Spigot	43 723 628
63 x 2" bsp	10	Long Spigot	43 723 311
90 x 3" bsp	10	Long Spigot	43 480 313
110 x 4" bsp	10	Long Spigot	43 480 314



Single Wall Female Compact Flange - bsp Long Spigot			
Size OD mm	PN bar	Description	Code
50 x 1 1/2" bsp	10	Long Spigot	43 721 310
63 x 2" bsp	10	Long Spigot	43 721 311
90 x 3" bsp	10	Long Spigot	43 484 313
110 x 4" bsp	10	Long Spigot	43 484 314



Single Wall Female Extended - bsp Spigot 750mm			
Size OD mm	PN bar	Description	Code
50 x 1 1/2" bsp	10	Extended Spigot - 750mm	43 481 310
63 x 1 1/2" bsp	10	Extended Spigot - 750mm	43 481 628
63 x 2" bsp	10	Extended Spigot - 750mm	43 481 311



Single Wall Female Extended - bsp (Gravity Fill & Vent Pipe) Spigot 750mm			
Size OD mm	PN bar	Description	Code
90 x 3" bsp	-	Extended Spigot - 750mm	43 735 313
110 x 4" bsp	-	Extended Spigot - 750mm	43 735 314



Single Wall Male Extended - bsp Spigot 750mm			
Size OD mm	PN bar	Description	Code
50 x 1 1/2" bsp	10	Extended Spigot - 750mm	43 752 310
50 x 1" bsp	10	Extended Spigot - 750mm	43 752 620

PLX Transition Fittings - Electrofusion/Spigot Fittings



Single Wall Female Compact Flange Extended – bsp (Max 4 bar application)

Spigot 750mm

Size OD mm	PN bar	Description	Code
50 x 1 1/2" bsp	4	Extended Spigot - 750mm	43 482 310
63 x 2" bsp	4	Extended Spigot - 750mm	43 482 311
90 x 3" bsp	4	Extended Spigot - 750mm	43 482 313
110 x 4" bsp	4	Extended Spigot - 750mm	43 482 314



Single Wall Female Compact Flange Extended – bsp (Gravity Fill & Vent Pipe)

Spigot 750mm

Size OD mm	PN bar	Description	Code
90 x 3" bsp	4	Extended Spigot - 750mm	43 736 313
110 x 4" bsp	4	Extended Spigot - 750mm	43 736 314



Secondary Contained – Close-Fit Female Extended – bsp

Double Spigot 750mm

Size OD mm	PN bar	Description	Code
50#63 x 1 1/2" bsp	10	Extended Spigot - 750mm	43 204 310
63#75 x 1 1/2" bsp	10	Extended Spigot - 750mm	43 204 628
63#75 x 2" bsp	10	Extended Spigot - 750mm	43 204 311

*All fittings are double spigot and complete with 1/8" access port.



Secondary Contained – Close-Fit Male Extended

Double Spigot 750mm

Size OD mm	PN bar	Description	Code
50#63 x 1 1/2" bsp	10	Extended Spigot - 750mm	43 203 310
63#75 x 1 1/2" bsp	10	Extended Spigot - 750mm	43 203 628
63#75 x 2" bsp	10	Extended Spigot - 750mm	43 203 311

*All fittings are double spigot and complete with 1/8" access port.



Secondary Contained - Close-Fit Compact Flange Extended

Double Spigot 750mm

Size OD mm	PN bar	Description	Code
50#63 x 40NW	10	Extended Spigot - 750mm	43 332 310
63#75 x 50NW	10	Extended Spigot - 750mm	43 332 311

*All fittings are double spigot and complete with 1/8" access port.

For more information on the Close-Fit Extended Transitions please go to page 13.



Secondary Contained - Close-Fit Female - bsp

Electrofusion - Three In One

Size OD mm	PN bar	Description	Code
32#40 x 1" bsp	10	39.5V	43 749 413
32#40 x 1" bsp	10	39.5V + access	43 750 413

For more information on this product please go to page 13.



Single Wall Drilled BS4504 Table 16 Stub Flange Assembly

Long Spigot

Size OD mm	PN bar	Description	Code
50 (40NW)	16	Long Spigot	43 271 310
63 (50NW)	16	Long Spigot	43 271 311
90 (80NW)	16	Long Spigot	43 271 313
110 (100NW)	16	Long Spigot	43 271 314
160 (150NW)	16	Long Spigot	43 271 317



Single Wall Drilled BS4504 Table 16 Stub Flange Assembly (Max 4bar application)

Long Spigot

Size OD mm	PN bar	Description	Code
50 (40NW)	4	Long Spigot	43 329 310
63 (50NW)	4	Long Spigot	43 329 311
90 (80NW)	4	Long Spigot	43 329 313
110 (100NW)	4	Long Spigot	43 329 314



Single Wall Drilled BS4504 Table 16 Stub Flange Assembly (Gravity Fill & Vent)

Long Spigot

Size OD mm	PN bar	Description	Code
90 (80NW)	-	Long Spigot	43 328 313
110 (100NW)	-	Long Spigot	43 328 314
160 (150NW)	-	Long Spigot	43 328 317



Secondary Contained In-Line Anchor

Double Spigot

Size OD mm	PN bar	Description	Code
32#63	10	Double Spigot	43 496 308
50#90	10	Double Spigot	43 496 310
63#110	10	Double Spigot	43 496 311
90#160	10	Double Spigot	43 496 313
110#160	10	Double Spigot	43 496 314
32#63	10	Double Spigot + Through Holes	43 396 308
50#90	10	Double Spigot + Through Holes	43 396 310
63#110	10	Double Spigot + Through Holes	43 396 311
90#160	10	Double Spigot + Through Holes	43 396 313
110#160	10	Double Spigot + Through Holes	43 396 314

For more information on this product please go to page 13.

PLX Transition Fittings - Electrofusion/Spigot Fittings



Secondary Contained Drilled Flange Assembly Double Spigot			
Size OD mm	PN bar	Description	Code
50#90 x 50 (40NW)	10	Double Spigot + Pecat PN16	43 333 310
63#110 x 63 (50NW)	10	Double Spigot + Pecat PN17	43 333 311
90#160 x 90 (80NW)	10	Double Spigot + Pecat PN18	43 333 313
110#160 x 110 (100NW)	10	Double Spigot + Pecat PN19	43 333 314



Secondary Contained Female - bsp Double Spigot			
Size OD mm	PN bar	Description	Code
32#63 x 1 1/2" bsp	10	Double Spigot + Female	43 356 308
50#90 x 1 1/2" bsp	10	Double Spigot + Female	43 356 310
63#110 x 2" bsp	10	Double Spigot + Female	43 356 311
90#160 x 3" bsp	10	Double Spigot + Female	43 356 313
110#160 x 4" bsp	10	Double Spigot + Female	43 356 314



Secondary Contained Male - bsp Double Spigot			
Size OD mm	PN bar	Description	Code
32#63 x 1 1/2" bsp	10	Double Spigot + Male	43 357 308
50#90 x 1 1/2" bsp	10	Double Spigot + Male	43 357 310
63#110 x 2" bsp	10	Double Spigot + Male	43 357 311



Secondary Contained Female Compact Flange - bsp Double Spigot			
Size OD mm	PN bar	Description	Code
32#63 x 1 1/2" bsp	10	Double Spigot + Female	43 358 308
50#90 x 1 1/2" bsp	10	Double Spigot + Female	43 358 310
63#110 x 2" bsp	10	Double Spigot + Female	43 358 311
90#160 x 3" bsp	10	Double Spigot + Female	43 358 313
110#160 x 4" bsp	10	Double Spigot + Female	43 358 314



Secondary Contained Elbow 90° Flanged (PE) Double Spigot			
Size OD mm	PN bar	Description	Code
90#160 x 80NW	10	Double Spigot + PN16	43 997 290
110#160 x 100NW	10	Double Spigot + PN16	43 997 164



Secondary Contained Elbow 90° Female bsp			
Double Spigot			
Size OD mm	PN bar	Description	Code
90#160 x 3" bsp	10	Double Spigot + Female	43 997 151
110#160 x 4" bsp	10	Double Spigot + Female	43 997 291



Secondary Contained Reduced Branch Flanged Tee			
Double Spigot			
Size OD mm	PN bar	Description	Code
90#160 x 50NW	10	Double Spigot + PN16	43 997 173
110#160 x 50NW	10	Double Spigot + PN16	43 997 165

For more information on this product please go to page 14.



Stage 2 Vapour Recovery Manifold			
Double Spigot			
Size OD mm	PN bar	Description	Code
32 x 63	10	4 Port Manifold	43 113 006
32 x 63	10	6 Port Manifold	43 113 010



AdBlue® Single Wall Male Extended - bsp (Stainless Steel)			
Spigot 750mm			
Size OD mm	PN bar	Description	Code
50 x 1 1/2" bsp	10	Extended Spigot - 750mm	43 753 310
50 x 1" bsp	10	Extended Spigot - 750mm	43 753 620
63 x 2" bsp	10	Extended Spigot - 750mm	43 753 311



AdBlue® Single Wall Female Extended - bsp (Stainless Steel)			
Spigot 750mm			
Size OD mm	PN bar	Description	Code
50 x 2" bsp	10	Extended Spigot - 750mm	43 997 212

PLX Accessories



Features

- Dedicated Range of machines
- Close-Fit pipe tools range
- Machine Pin adaptors

Benefits

- Ensuring traceable welding records
- Ensuring Primary pipe protection
- For jointing Secondary Contained systems



Chamber and Sump Entry Boots

Size mm	Description	Form	Code
50	DuraBoot	Fixed	43 281 310
63	DuraBoot	Fixed	43 281 311
75	DuraBoot	Fixed	43 281 312
90	DuraBoot	Fixed	43 281 313
110	DuraBoot	Fixed	43 281 314
160	DuraBoot	Fixed	43 281 317
50	DuraSeal EntryBoot	Threaded	43 270 310
63	DuraSeal EntryBoot	Threaded	43 270 311
75	DuraSeal EntryBoot	Threaded	43 270 312
90	DuraSeal EntryBoot	Threaded	43 270 313
110	DuraSeal EntryBoot	Threaded	43 270 314

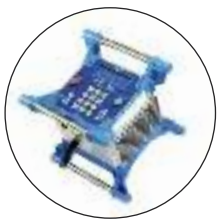

Machines

Size mm	Description	Form	Code
32-315	Manual	110V	43 ECU 001
32-315	Manual	220V	43 ECU 002
32-315	Auto/Manual	110V	43 ECU 003
32-315	Auto/Manual	220V	43 ECU 004
32-63	Manual & Mobile (battery operated - Nomad - Unit, spare battery and charger)	110V	43 ET1 ULN
Machine pin adaptors	4.7mm x wire EF	Spring Adaptors	43 EW0 004



Pipe Tools		
Size mm	Form	Code
32-110	Surface Preparation Kit	43 MZO 018
110-225	Surface Preparation Kit	43 SPA 020
All sizes	Hand Scraper	43 SPA 012
32-63	Pipe Cutter	43 777 100
50-110	Pipe Cutter	43 728 100
110-160	Pipe Cutter	43 728 102
32#40	Pipe Protection Sleeve	43 494 308
50#63	Pipe Protection Sleeve	43 494 310
63#75	Pipe Protection Sleeve	43 494 311
32-63	Superclamp (Inline only)	43 MA0 101
50-110	Superclamp (Inline only)	43 MZO 023
32-63	Superclamp (0°-90°) Indexed	43 MA0 105
50-110	Universal Pipe Clamp (0°-90°)	43 MZO 022
Isopropanol Wipes	Tub 100 wipes	43 451 101
Loctite 577	Thread Sealant	43 451 102

Durapipe Leak Detection System by Andel Limited

Durapipe recommend a leak detection system from Andel Limited. Andel Limited was formed in 1992 and with a commitment to service, product development and quality, has a proven track record as the market leader in leak detection systems.

The sensor uses infrared to detect the presence of any liquid touching the sensor dome. When liquid is detected, the relay within the local control unit will turn off, and therefore be detected by a monitoring system. The relay will also turn off if the sensor should become disconnected or if the power should fail.

The Andel Pipe-in-Pipe leak detection system is designed for applications where a stand-alone leak detection system is required. The system consists of two components, the sensor head and local control box. The sensor head is a 1" BSP fitting and can be installed onto a standard leak detection kit using a standard threaded branch tee.

The sensor head is designed using an optical level sensor. The sensor head will be encapsulated and fit into a standard 1" BSP female socket and comes complete with 2m of connection cable. The ingress protection of the unit is IP65.



Floodline central alarm panels are also available from Andel to monitor one or more sensors if required, providing both local audible and visual alarms as well as a full range of volt-free contacts for onward connection to a building management or other type of monitoring system.

Electrofusion Jointing

Durapipe PLX pipes and fittings are jointed by Electrofusion welding. Electrofusion is a simple, quick and easy method of jointing plastic pipe systems producing high integrity, permanent joints. Electrofusion has been an approved method of jointing polyethylene systems in the international gas and water industry for many years.

Prior to jointing, the outer surface of the PLX pipe or PLX spigot fitting must be removed.

Pipe surfaces can be prepared using a PLX Pipe Preparation tool. The PLX Multi-pipe Preparation Kit (PLX product code 43 MZ0 018 (32-110mm) or 43 SPA 020 (110-225mm), is designed to mount concentric to the pipe and respective to pipe size and class interchangeable expanding mandrels and sleeves ensure the tool is held firmly in place during the peeling operation. Rotating about the pipe axis the spring loaded HSS cutter tip ensures, regardless of operator that an even amount of material is removed.

PLX spigot fittings must be scraped manually using a PLX hand scraper.

Abrading the pipe end or fitting end prior to fusion is not effective in removing the outer surface. Years of experience has shown that to achieve maximum joint strength it is essential that the pipe surfaces are scraped or peeled.

Prepared pipe surfaces should always be kept clean and pipe preparation should always take place immediately prior to fusion welding. If this is not possible, the prepared surface of the pipe must be covered to protect it from contamination.

If left for a period of time or dirtied both joint surfaces must be cleaned with an Isopropanol wipe before welding (PLX product code 43 451 100).

Each electrofusion fitting is sealed in a bag at the point of manufacture to protect the surfaces against contamination and damage. Do not open the bag until required.

Electrofusion fittings must not be scraped.

CAUTION

- **DO NOT** allow water to penetrate the joint prior to or during fusion welding
- **DO NOT** assemble or begin fusion PLX systems if either pipe ends or fitting are contaminated with any deleterious material
- **DO NOT** use near naked flames
- **DO NOT** smoke in the working area
- **DO NOT** joint in rainy conditions unless a shelter is provided to keep surfaces dry

Pipe Preparation Instructions

The Durapipe PLX range comprises of three systems, Single Wall, Secondary Contained Close-Fit and Pipe-In-Pipe. As these systems are different there are differences in pipe preparation.

You will need:

- PLX Pipe cutter
- PLX Pipe preparation kit or PLX hand scraper
- PLX Isopropanol Wipes
- Tape measure
- Pipe marking utensil
- Pipe protection sleeve (Close-Fit only)

All Single Wall – Primary Pipe Preparation

1. It is important to make sure the pipe is cut clean and square, a wheel cutter is best for this job. The use of a cutter ensures a square swarf-free pipe end preparation.



2. Wipe loose dirt from pipe ends.



3. Measure the fitting from the centre to the end using a tape measure. Mark the pipe, using a utensil, around the circumference, with the recorded measurement.



4. Using the PLX pipe preparation kit select the correct size mandrel to fit the pipe being prepared. Rotate the mandrel shaft anti-clockwise so that the mandrel expands and firmly grips the inside of the pipe. Using the spanner tighten the mandrel with 1/4 turn.



5. Place the preparation tool onto the shaft and slide along by depressing the release button to disengage the drive until the cutter tip is aligned with the marked socket depth. Position the cutter tip approximately 1mm above the pipe surface.

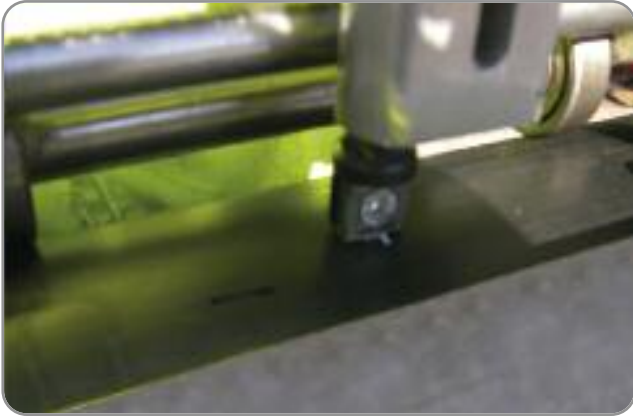

6. Apply the spring tension to the cutter tip. Then rotate the tool clockwise until the cutter has moved over the length of pipe to be prepared. A continuous ribbon of PE material should have been removed.



7. Durapipe PLX Isopropanol wipes are available to wipe the pipe surface should they become contaminated.



8. Mark the pipe again using a utensil and a tape measure or the PLX pipe fitting.



9. You can begin the electrofusion process.

Close-Fit – Pipe Preparation

1. It is important to make sure the pipe is cut clean and square, a wheel cutter is best for this job. The use of a cutter ensures a square swarf-free pipe end preparation.



2. Wipe loose dirt from pipe ends. Mark the outer pipe to approximately 150mm from the edge, using a tape measure and pipe marking utensil.



3. Manually prepare the surface of the green outer pipe using a scraper, from the mark up to the end of the pipe.



4. Measure the primary fitting from the centre to the end, marking this dimension + an additional 10-15mm on the surface of the green outer pipe using the marking utensil.



5. Place the PLX Pipe protection sleeve between the primary and secondary pipe.



6. Cut the pipe square using a PLX pipe cutter. The use of a cutter ensures a square swarf-free pipe end preparation.



7. Safely remove the PLX Pipe protection sleeve together with the unwanted secondary pipe.



8. Mark the pipe again using a utensil and a tape measure or the PLX pipe fitting.
9. Now proceed to follow Primary Pipe Preparation guidelines steps 1-9.

Pipe-In-Pipe – Pipe Preparation

1. Pipe-In-Pipe is supplied in a loose fit form where the primary pipe is centralised within the bigger pipe using spacers. The spacer can easily be repositioned to suit installation.



2. It is important to make sure the pipe is cut clean and square, a wheel cutter is best for this job.



3. Measure the width of the PLX Secondary Coupler.



4. Mark the outer pipe to approximately the width of the PLX Secondary Coupler, using a tape measure and pipe marking utensil.



- Place the preparation tool onto the shaft and slide along by depressing the release button to disengage the drive until the cutter tip is aligned with the marked socket depth. Position the cutter tip approximately 1mm above the pipe surface.



- Apply the spring tension to the cutter tip. Then rotate the tool clockwise until the cutter has moved over the length of pipe to be prepared. A continuous ribbon of PE material should have been removed.



- Durapipe PLX Isopropanol wipes are available to wipe the pipe surface should they become contaminated.
- Mark the pipe again using a utensil and a tape measure or the PLX pipe fitting.



- Now proceed to follow Primary Pipe Preparation guidelines steps 1-9. Using the pipe preparation tool (for pipe sizes above 110mm use tool 43 SPA 020).

Single Wall Jointing Guide

1. Remove fitting from packaging. Place the pin mushroom caps close to where you are performing jointing.



2. Wipe the inner bore of the fitting with an isopropanol wipe ensuring it is clean only if necessary.



3. Push the fitting onto the pipe. Ensure the correct insertion and mark the position relative to the Pipe.



4. Repeat for the opposite socket and place pipe onto PLX Pipe clamp for stability.



5. Connect the leads from the electrofusion control unit to the terminals on the fitting. The lead connectors can be attached to either terminal.



6. Note the fusion time on the fitting barcode.



7. Enter the fusion time. Press the green or enter button to proceed. Durapipe offers both manual and barcode reading Electrofusion control units. The barcode reading units have a light pen, which the operator uses to input the necessary data.



8. At the end of the fusion cycle the indicator pins will have risen. Remove the electrofusion control unit leads.



9. After the cooling time is shown on the fitting barcode, insert the pin mushroom caps to prevent an accidental repeat of the fusion process.



Secondary Containment Fittings

The PLX Secondary containment system has a number of specific secondary containment fittings designed to ensure the primary system is independent to the secondary ensuring a complete leak tight system.

The PLX Secondary containment fittings range are manufactured and fabricated with the terminal shroud of the fitting reduced to fit inside the secondary spigot fitting. A flying lead is fitted to each terminal to provide connection to the electrofusion unit.

Before fusion begins, ensure that the surface of the secondary spigot fitting has been prepared using a PLX Hand scraper.

PLX Terminal Adaptors (43EW0004) are designed to connect the flying leads of the fitting to the electrofusion control unit connection leads.

The outer sleeving of the flying leads is pre-cut, but left in place to protect the wire ends from fraying. Remove this outer sleeve by twisting, inserting the 'bared' wire into the hole provided in the PLX Terminal Adaptor. The PLX Adaptor is spring loaded and requires the plunger to be squeezed in order to expose the holes and allow for the wire insertion. When released the wire will be firmly held in position. The brass end then becomes the pin for connecting to the Electrofusion control unit.

After fusion and cooling periods have elapsed, remove the PLX Terminal Adaptors. As fusion is now complete, the flying leads may be cut, as they serve no further purpose.



Close-Fit Secondary Containment Jointing Guide

It is important before you begin to follow the Pipe Preparation Guide in the previous chapter. For all Close-Fit Secondary containment Jointing PLX Closures must be used at either side of the fitting.

1. Remove fittings from packaging
2. Place pin mushroom caps close to where you are performing jointing.
3. Wipe the inner bore of the fitting with an isopropanol wipe ensuring it is clean, only if necessary.
4. Mark the socket entry depths on all the pipes.
5. Ensure that all spigot fittings are manually scraped revealing a virgin layer of PE for welding.



6. Push the fittings onto the pipes, ensuring the PLX Closure fittings are positioned on the secondary pipe, either side of the fitting. Ensure correct insertion to the marked positions for both sockets.



7. Attach the PLX terminal adaptors (43EW0004) as per guidelines below.



8. Connect the leads from the electrofusion control unit to the PLX terminal adaptors. The lead connectors can be attached to either terminal.



9. Note the fusion time on the fitting barcode.



10. Enter the fusion time. Press the green or enter button to proceed. Durapipe offers both manual and barcode reading Electrofusion control units. The barcode reading units have a light pen, which the operator uses to input the necessary data.



11. Remove the PLX terminal adaptors.

12. The flying leads may be cut as they serve no further purpose.



13. Position the secondary PLX Closures onto each side of the spigot fitting.



14. Connect the leads from the electrofusion control unit to the secondary closures.



- 15.** Enter the fusion time. Press the green or enter button to proceed. Durapipe offers both manual and barcode reading Electrofusion control units. The barcode reading units have a light pen, which the operator uses to input the necessary data.



- 16.** At the end of the fusion cycle the indicators will have risen.
- 17.** After allowance of the cooling time as shown on the fitting, insert the mushroom caps to prevent an accidental repeat of the fusion process and also to insulate the terminals.



Pipe-In-Pipe Secondary Containment Jointing Guide

Before you begin, it is important to follow the Pipe Preparation Guide in the previous chapter. For all Pipe-In-Pipe Secondary Containment Jointing, PLX Secondary Couplers or PLX Closures can be used at either side of the fitting.

1. Remove fittings from packaging
2. Place pin mushroom caps close to where you are performing jointing.
3. If necessary, wipe the inner bore of the fitting with an isopropanol wipe ensuring it is clean.



4. Measure the fitting from the centre to the end using a tape measure. Mark the socket entry depths on all the pipes.



5. Push the fitting onto the pipes, ensuring the PLX Secondary Coupler is in place.



6. Ensure the correct insertion to the marked positions for both sockets.



7. Place on Pipe Clamp to ensure stability.



- 8.** Attach the PLX terminal adaptors (43EW0004) as per guidelines below.



- 9.** Connect the leads from the electrofusion control unit to the PLX terminal adaptors. The lead connectors can be attached to either terminal.

- 10.** Note the fusion time on the fitting barcode.
- 11.** Enter the fusion time. Press the green or enter button to proceed. Durapipe offers both manual and barcode reading Electrofusion control units. The barcode reading units have a light pen, which the operator uses to input the necessary data.



- 12.** Remove the PLX terminal adaptors.
- 13.** The flying leads may be tucked into the space between the primary and secondary pipes, or they can be cut as they serve no further purpose.



14. Remove the primary pipe clamps and push the secondary pipes together and pull over the PLX Secondary Coupler into place.



15. Note the fusion time on the fitting barcode.

16. Enter the fusion time by using the up and down buttons. Press the green button to proceed. Durapipe offers both manual and barcode reading Electrofusion control units. The barcode reading units have a light pen, which the operator uses to input the necessary data.



17. At the end of the fusion cycle the indicators will have risen.



18. After allowance of the cooling time as shown on the fitting, insert the mushroom caps to prevent an accidental repeat of the fusion process and also to insulate the terminals.



Installation Guide

Durapipe PLX products are designed to make the installation of fuel lines quicker, easier and more cost-effective than when using traditional materials. The advantages of installing with PLX systems are lightness flexibility, durability and totally secure jointing methods.

PLX System Presentations, Demonstrations and Technical Support

We offer an unrivalled level of technical support where our experienced team can provide product introductions, jointing demonstrations and installation advice on any given project. They can also provide material take-off advice from architects' drawings.

Personnel should be fully competent and conversant with the design and installation of PLX pipe systems.

On-site PLX pipe jointing demonstrations can be arranged on request.

Technical Support is available, before, during and after installation.



Trench Excavation

Where pipework has to be laid in trenches, PLX pipe systems require minimal excavation. Trench dimensions are normally governed by the pipe diameter and site conditions. In general, they should be as narrow as possible, but typically not less than the outside diameter of the pipe plus 250mm to allow for correct compaction of the side fill.

Minimum depth of cover for PLX should be 750mm from ground level to crown of the pipe. It is acceptable to lay pipes directly on the bottom of the trench, provided that the soil is uniform, relatively soft and fine grained and free from large flints, stones and other hard objects, which could damage the pipe wall. The trench bottom should be brought to an even finish to provide consistent support to the pipes along their complete length.

Where pipes are to be laid side by side in wide/open trenches, a minimum cover of 100mm is required and a minimum gap of 100mm should be left between pipes.

100mm thickness of selected bedding material must be placed below the pipe. Gravel or broken stone graded between five and ten millimetres in size will provide suitable bedding since it requires little compaction. Coarse sand is also acceptable provided that the particle size is not less than 3mm but care must be taken to ensure that such backfill cannot migrate as the result of high water tables. Where this possibility prevails, then the trenches must be lined with a geotextile material to prevent the migration.



Pipework must be laid to a gradient of 1:100 back to the tank. Heavy compaction equipment should not be used until the fill over the crown of the pipe is at least 300mm.

Any temporary levelling supports must be removed before the pipework is backfilled to prevent any damage to the pipe resulting from uneven settlement.

Use PLX Close-Fit Pipe Coils to reduce the number of joints required for the installation where possible.

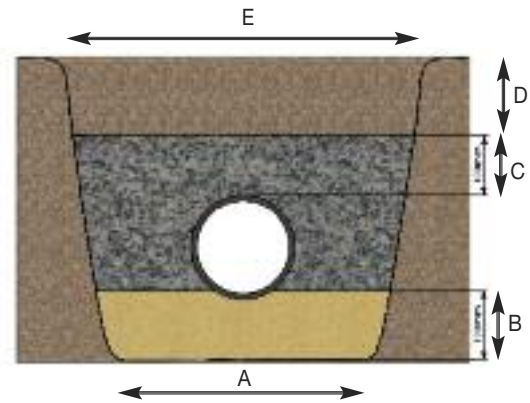

Pipe Diameter	A	B	C	D	E
110mm and below	450	100mm minimum	100mm minimum	150mm minimum	lower trench width + 600mm
150mm	450	100mm minimum	100mm minimum	150mm minimum	lower trench width + 600mm
250mm	500	100mm minimum	100mm minimum	150mm minimum	lower trench width + 600mm
315mm	600	100mm minimum	100mm minimum	225 minimum	lower trench width + 600mm

During pipe installation a pipe cross over may be difficult to avoid. Where they occur there must be a filled space between the uppermost pipe and the one beneath. If the pipes are touching this could cause a concentrated load that may result in premature system failure or cause an uneven settlement and liquid to be trapped in system – See PLX spacing recommendations on page 53.

Size for Size Replacement

Size-for size replacement or upsizing of existing iron pipelines can be achieved with significant savings by the pipe bursting method. With this technique an existing main is cracked open and the borehole simultaneously expanded by mole. Modern pipe bursting moles – especially those with hydraulically expanding segments – can crack and open out an unserviceable pipeline, even if it has repair collars of concrete surrounds. Risk of damage to adjacent utility installations is minimised by using hydraulic moles, helping to maximise the cost advantages of using the existing 'hole in the ground'.

Sliplining

In sliplining, a replacement PLX pipe system is inserted into an existing decommissioned pipeline.

Though some reduction in flow capacity is inevitable, this can be minimised by careful preparation and cleaning of the old pipe so that the largest possible diameter of new PLX can be inserted. In many instances an average annular clearance of as little as five per cent of mains diameter – less still for sizes above 300mm – has proven adequate where pipelines are reasonably straight and of uniform bore. In pressure pipelines the reduction in carrying capacity can also be compensated for by an increase in internal pressure. In gravity applications any affect of bore reduction is minimised both by the exclusion of ground water entering the system and by the improved flow characteristics of PLX.

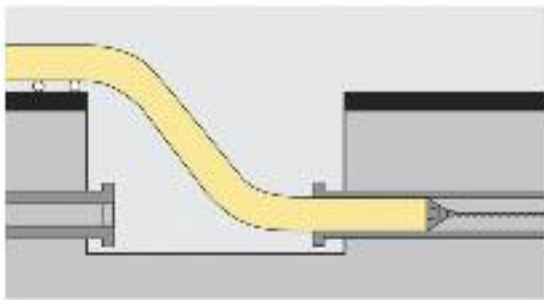

Sliplining (not to scale)

Die Draw Insertion

This method works by pulling a pre-welded string through a reducing die and into the old pipeline in one operation. Re-expansion to a to a close-fit diameter occurs naturally within a few hours of the wincing load being released.

Shallow and Encased Trenching

Where pipes are to be laid to shallow depths, the pipe must be protected by reinforced concrete to transfer any excessive loadings resulting from the passage of heavy vehicles. In exceptional circumstances, where pipework needs to be totally encased in concrete, the pipework should also be wrapped to prevent differential stresses being applied to the pipe.

Underground Pipe Spacing Recommendations

When installing PLX in below ground trenches there is a minimum gap requirement between each pipe being buried. If pipes are installed too close together they are unsupported by the backfill and may buckle and cause the ground to depress. Durapipe recommends the following per diameter of PLX pipes.

Pipe Outer Diameter	Gap
32-63mm	50mm
75-110mm	75mm
160mm	100mm



Above-ground Supported Installation

For exposed supported above ground pipework proper anchorage is essential. The structure and anchorages must resist or accommodate thermal stresses or movement over the ambient temperature range to which the pipe system will be subjected. Above ground PLX systems should preferably be installed at or near maximum operating temperature. In this way the pipe will be thermally expanded when clamps or supports are bolted into position – See UV protection and pipe supports section on page 54.



Expansion and Contraction

The thermal expansion of Durapipe PLX is 1.5mm/metre/10°C, which is greater than for metal. Allowance must be made for this when designing a PLX installation above ground, where significant temperature variation is expected. If the above length change is re-stated as 9mm per 6m pipe length per 10°C of temperature change, the magnitude of potential thermal movement can be better appreciated. In above ground installations the natural flexibility of the pipe, coupled with judicious siting of anchor and support brackets, will conveniently accommodate expansion and contraction at changes of direction. In installations where fully end-load bearing joints are used, the compressive or tensile forces set up in the pipeline due to constraint of thermal movement will not detract from long-term performance, but the effects of these forces on pipe support, ancillary equipment and so on, must be considered and allowances made.



The potential for thermal movement is a particular issue where (fully end-load bearing) PLX is connected to any non end-load bearing mechanically jointed system. It is essential that such transitions are securely anchored, to obviate the risk of any joints in the mechanically jointed system separating.

It is also prudent to allow a newly installed pipeline time to conform to ambient temperature before end connections are made.

UV Protection and Pipe Supports

Durapipe PLX Secondary Contained Pipe-In-Pipe systems provide excellent resistance to UV light and can be safely installed in some above ground applications. For greatest protection against accidental damage or weathering, only PLX Pipe-In-Pipe systems should be used. Pipe-In-Pipe Black PE outer pipework provides excellent resistance to UV light and only straight lengths should be used. PLX Pipe-In-Pipe should be rigidly fixed and used in conjunction with flat bar saddle clips and pipe supports should be no less than 40mm wide. Pipe clips should permit free axial movement and should not restrict expansion or contraction.



Above Ground (Pipe-In-Pipe) Pipework Maximum Support Spacing (metres)

Pipe Dimensions (mm)	Support Centres
32#63	1.0M
50#90	1.1M
63#110	1.2M
90#160	1.5M
110#160	1.5M

Both PLX Pipe-In-Pipe and Close-Fit systems can be installed in below ground formed pipe ducts with the following support guide:

Ducted Pipe-In-Pipe Maximum Support Spacing (metres)

Pipe Dimensions (mm)	Support Centres
32#63	1.0M
50#90	1.1M
63#110	1.2M
90#160	1.5M
110#160	1.5M

Ducted Close-Fit Maximum Support Spacing (metres)

Pipe Dimensions (mm)	Support Centres
32#40	Continuous
50#63	Continuous
63#75	Continuous

PLX Close-Fit pipes can only be installed in below ground applications, either buried, or in a covered duct. If in a covered duct it can be laid on the floor of the duct, or continuously supported using an electrical cable tray or similar. After installation of the pipes a light aggregate or coarse sand is preferred as coverage.



Pipe Bending

The minimum bend radius for Durapipe PLX product lines supplied in straight lengths is 25 times the pipe outside diameter. For Secondary Containment systems the outside diameter of the outer pipe must be used as the base calculation. Electrofusion joints should not be subjected to bending stresses until they have fully cooled.

Durapipe PLX Earth Bonding Instructions

Where PLX (non-conductive) pipes are used, there is a requirement to provide earthing and bonding to equalise electrical potential of the underground piping system. Always consult a competent electrical engineer with good knowledge of local and regional rules and regulations.

Key points for effective earth establishment are: Ensure all electrofusion terminal insulating caps are correctly inserted. All stand alone metal components such as metal backing rings attached with PE stub flanges must be earthed.

Some guidelines are:

NFPA77 – National Fire Protection Association, Recommended Practice on Static Electricity

CENELEC CLC/TR 50404 Electrostatics

Pressure Testing of PLX Product Lines Single Wall and Secondary Containment

It is important to remember that site pressure tests are carried out to determine that the installer has fused all electrofusion joints and that all threaded connections have been made.

Pressure testing to prove the suitability of the PLX system has already been carried by Durapipe at much higher pressures than would be allowed on site, during the systems design, development and subsequent approval.

Further stringent test regimes have also been performed by the many Independent Test Bodies who have certified that PLX is suitable for use as an underground pipework system for conveying liquid fuels.

Health and Safety

- Compressed air may be used to test new pipework systems.
- Nitrogen, which is an inert gas, must always be used to test existing lines where vapours or liquid fuels may still be present. The nitrogen gas will also serve to purge the pipework of any vapours and air. Site Management must always be informed when a pressure test is due to be carried out using compressed gases at these higher pressures to ensure the safety of other site personnel.
- Compressed gases occupy 3 times the volume of a given space (when compared to water) to give the equivalent pressure. Separation of any item within the system would have an explosive effect due to the sudden release of this stored energy.
- The maximum pressure of 4bar for primary (product line) and 2bar for Secondary containment should never be exceeded because of these safety concerns.

Pressure Test Guidelines

- All pressure testing equipment should be subject to manufacturers calibration requirements before use.
- All tank connections above ground or below ground should be disconnected or isolated.
- For accurate consistency of the pressure measurement it is recommended that the target pressure should be a minimum of 50% of the gauge scaling ie. a test pressure of 4bar (60psi) the gauge range to be 0 to 8bar (0 to 120psi).
- It is recommended that a suitable pressure relief valve be incorporated into the system to prevent overcharging of the pipe. This should be set at no more than 0.5bar (10psi) above the target pressure.
- When pressure testing the primary pipe, the secondary containment pipe must be open to atmosphere, this is also applicable for testing of the secondary leaving the primary pipe open to atmosphere.
- The use of compressed air is suitable as a medium for pressure testing the pipe system.
- The use of Nitrogen (from a pressure cylinder) for pressure testing of the pipe system should be applied when the pipe system has been used:
 - for pressure testing existing lines under planned maintenance procedures.
 - or if a fuel has been used to ballast a storage tank.

Pressure Testing Procedure for Primary (product) Lines

Test heads are fixed to transition fittings (at the dispenser) to allow pressure to be introduced and for the internal pressure to be measured. The other end (at the tank) must be closed off using spade connections between the compact flange/ flange connections to ensure that the tank is both isolated and that the pressure test is not also being applied to the tank.

- Introduce air/nitrogen to an initial pressure of 0.5bar (10psi).
- Examine all the electrofusion joints and threaded joints for any leakage using soap solution (where possible).
- The pressure may then be raised in 0.5bar increments over 15 minute intervals to a maximum pressure of 4.0bar (60psi).
- Once the target pressure is reached, measurements should be taken from the pressure gauge:
 - The minimum duration of test should be 1 hour.

NB: Polyethylene pipe is subject to creep under pressure and temperature. It may be necessary to apply a 'top up' to the pressure in the system after a few minutes to allow for these material fluctuations under ambient temperatures. Consideration must be made for higher temperature factors.

Pressure Testing Procedure for Secondary Containment Lines

Electrofusion Type Closures

Durapipe has designed and developed Electrofusion Short Pattern closure/Stepped coupler fittings to fuse the outer containment pipe/fittings to the outside of the PLX product line pipes.

These fittings are designed to seal the interstice by electrofusion, and where fitted with access ports, permit connection to monitoring equipment using all the different mediums.

- Introduce air to an initial pressure of 0.5bar (10psi).
- Examine all the electrofusion joints and threaded joints for any leakage using soap solution (where possible).
- The pressure may then be raised in 0.5bar increments over 15 minute intervals to a maximum pressure of 2.0bar (30psi).
- Once the target pressure is reached, measurements should be taken from the pressure gauge:
 - The minimum duration of test should be 1 hour.

NB: Polyethylene pipe is subject to creep under pressure and temperature. It may be necessary to apply a 'top up' to the pressure in the system after a few minutes to allow for these material fluctuations under ambient temperatures. Consideration must be made for higher temperature factors.

Note:

The PLX Electrofusion Closure Fittings and the access ports are designed to allow the interstice to be monitored using over pressurization methods up to a maximum continuous working pressure of 4bar (60psi).

These fittings have been designed for use as secondary containment closure fittings only and are marked as such. They must NEVER be used to connect PLX product lines (Suction/Pressure) or PLX Fill & Vent lines.

Application Specific Installation Overview

Before Durapipe PLX pipe can be installed, ensure that the site is prepared. With all PLX installations there will be requirements for connection to either above or below ground fuel storage tanks, or other form of system apparatus. Installations with underground storage tanks will also have Fill & Vent lines to maintain constant pressure in the tank.

Forecourt Applications

Two methods are used to move the fuel from the tank to the dispensers:

Suction: this is when the dispensing pumps create a vacuum which draws the fuel from the tank to the dispenser.

Pressure: this is when submersible pumps in the storage tanks create a positive pressure which pushes the fuel to the dispensers.

Products for these systems:

Suction uses predominantly single wall product. This is because if there was a leak the vacuum prevents the fuel escaping.

Pressure uses secondary containment product. If there is a leak the fuel will be contained in the secondary pipe until the fault is detected and repaired.



PLX is installed for the key applications within a forecourt:

- Offset Fill
- Vents
- Vapour Recovery
- Pump, Dispenser and Tank Connections
- Tank Chamber Connections



Offset Fill

An offset fill pipe is used for filling each of the underground tanks from a remote point, usually at the perimeter of the forecourt. The smooth bore of polyamide lined PLX Fill & Vent pipe improves flow and reduces the fill time of the Underground Storage Tanks (USTs). With minimal available gravity head, frictional losses must be considered operating under gravity head, the fill pipe should be considered as a pressure system and can be installed using PLX Secondary Contained systems.

Typical sizes used for this application are 90mm/110mm. Available products are PLX Fill & Vent pipe (SDR17), electrofusion elbows, couplers, tees and transition fittings.



Vents

Vents are provided in order to allow air to be drawn into the tanks as liquid is dispensed and to act as an emergency pressure release for the tank vapour collection system. The smooth bore of PLX Fill & Vent pipe will assist air/vapour flow and the condensed vapour return to its UST.

Typical sizes used for this application are 63mm and 90mm. Available products are PLX Fill & Vent pipe (SDR17), electrofusion elbows, couplers, tees and PLX transition fittings for safe connection to the vent and storage tank.



Vapour Recovery

Vapour recovery is the recovery of the vapour from the Underground Storage Tanks to the tanker truck during the refuelling process.

Typical size used for Stage One is 90mm. Available products are PLX Fill & Vent pipe, electrofusion elbows, couplers, tees and transition fittings.

Typical sizes used for Stage Two are 32mm-63mm. Available products are PLX 32mm and 63mm, PLX pipe, electrofusion elbows, couplers, tees and transition fittings.

Tank Chamber Connection (UST)

The tank chamber is central to the forecourt fuel system, it provides inspection access to the tank and protects the pipe and pump connections. With space at a premium the innovative design of PLX electrofusion demountable compact flanges helps to minimise installation time and ensures easy access to the tank connections.

Available products are PLX Single Wall and Secondary Contained pipe, electrofusion elbows, couplers, tees and transition fittings.



Pump, Dispenser and Tank Connections

PLX threaded transition fittings and compact flanges provide a safe and secure connection to pumps, dispensers and tanks. Designed for pressure and suction applications PLX spigot and electrofusion threaded adaptors are suitable for dispenser connections whilst compact demountable flanges are suitable for use in the confined and restricted access of tank chambers. PLX Secondary Contained fittings and extended transitions can help to reduce costs and eliminate the need for dispenser sumps.

Available products are PLX Single Wall and Secondary Contained pipe, electrofusion elbows, couplers, tees and transition fittings.



Forecourt Installation

Where pipes are to be laid side by side in wide/open trenches, as used in forecourt installations, a minimum cover of 100mm is required and a minimum gap of 100mm should be left between pipes.

100mm thickness of selected bedding material must be placed on the ground before pipes can be laid. Gravel or broken stone, graded between five and ten millimeters in size, will provide suitable bedding since it requires little compaction. Coarse sand is also acceptable, provided that the particle size is not less than 3mm, but care must be taken to ensure that such backfill cannot migrate as the result of high water tables. Where this possibility prevails then the trenches must be lined with a geotextile material to prevent the migration.

Pipework must be laid to a gradient of 1:100 back to the tank. Heavy compaction equipment should not be used until the fill over the crown of the pipe is at least 300mm.

Any temporary leveling supports must be removed before the pipework is backfilled to prevent any damage to the pipe resulting from uneven settlement.



Power Supply Applications

Durapipe PLX Close-Fit semi-flexible coils are suitable for underground fuel supply and return lines for fuel oil applications. PLX Close-Fit coils will reduce installation time and costs compared to using traditional materials. The transfer from below ground to above ground can be safely made between PLX Close-Fit and Pipe-In-Pipe systems, for connections to storage tanks, generator day tanks and oil-fired equipment.



PLX is installed for key applications within the Power Supply market:

- Uninterrupted Power Supply
- Emergency Power Supply
- Heat and Power Supply



Uninterrupted Power Supply

PLX is the ideal pipe system for uninterrupted power supply applications. In buildings such as data centres where any loss of power, and subsequent loss of information could be financially catastrophic, an Uninterrupted Power Supply (UPS) is imperative. Uninterrupted Power Supply (UPS) systems rely on emergency generators. These in turn need a reliable pipework system for their fuel supply. PLX pipework meets this need.

PLX pipework is suitable for supplying fuel for a UPS system.

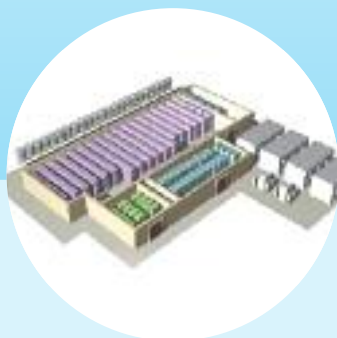

Emergency Power Supply

PLX pipework is used to safely transport fuel from storage tanks to generators for emergency power supply applications. PLX pipework is maintenance free and ensures a reliable flow of fuel to the back-up generator when called upon.

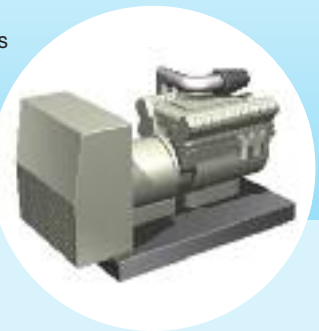

Heat and Power Supply

For buildings in remote locations, PLX can be used to convey fuel to boilers and generators providing heating and power.



Offset Fill & Vent

Specifically designed PLX Fill & Vent pipe reduces time and costs when filling underground fuel storage tanks. PLX Fill & Vent is also suitable for venting the system to ensure the tank and associated pipework are pressure balanced.

An 'offset fill' is used for filling each of the underground tanks. With minimal available gravity head, frictional losses must be considered. Even though operating under gravity head, fill pipe should be considered as a pressure system and can be installed using PLX secondary contained systems.

Typical sizes used for this application are 63mm, 90mm and 110mm. Available products are PLX and PLX Fill & Vent pipe, electrofusion elbows, couplers, tees and transition fittings for safe connection to the offset fill and storage tank.

Vent equipment ensures the safe holding and balancing of vapour control of the underground storage tanks. Vents and vapour recovery systems ensure that Underground Storage Tanks (USTs) and associated pipework are pressure balanced and that air and fuel vapour are safely recovered.

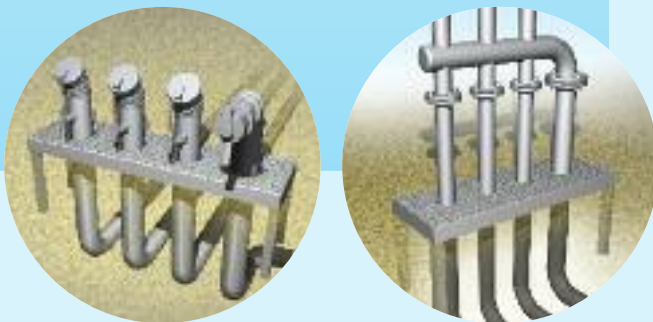

Tank Chamber Connection (UST)

The tank chamber is central to the forecourt fuel system, it provides inspection access to the tank and protects the pipe and pump connections. With space at a premium the innovative design of PLX electrofusion demountable compact flanges helps to minimise installation time and ensures easy access to the tank connections.

Available products are PLX Secondary Containment pipe, electrofusion elbows, couplers, tees and transition fittings.



Connection to System Apparatus

PLX Transition fittings ensure the safe continuous flow of fuel when connecting to metal threaded system apparatus. Each transition fitting has been innovatively designed and manufactured using the highest quality PE and a wide range of metals. With the process of installation in mind; each fitting is developed to save time and costs during the installation process.



Power Supply Installation

These installations could be trenching or require pipework to be situated within a duct. PLX Pipe-In-Pipe systems are UV resistant and can be safely installed in some above ground applications with the use of pipe supports. Please refer to the installation guidelines and contact our Technical Support Team if you require further information.



Transport Refuelling

The pipework requirements when conveying fuel for transportation vehicles via mass distribution can be complex and diverse, Reliability of the pipe system is of paramount importance.

Naturally, all modes of transport require fuel to enable them to function as required, for example marinas, airports, railway stations and haulage distribution depots all need fuel. Durapipe PLX large diameter specialist pipe systems are required to meet the needs of bulk refuelling for centralised depots that feed various types of transport vehicles.



PLX is installed for key applications within the Transport Refuelling market:

- Aviation
- Haulage or Distribution Centres
- Rail
- Marinas
- Tunnels



Aviation

PLX is corrosion resistant, as well as being compatible with civil and military grade aviation fuels. PLX ensures a clean supply to all aviation refuelling activities. PLX pipe systems, together with our selection of fittings to suit, are suitable for these types of installations.

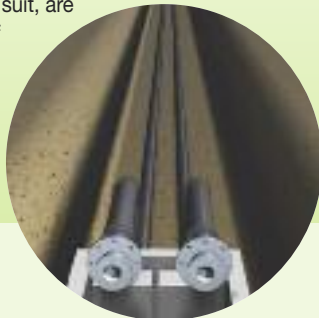

Rail

Compact, robust and maintenance free, PLX is protected against accidental damage and freezing conditions. Easily installed into pre-formed shallow ducts, PLX systems are suitable for fuel and lubrication oil dispensing applications.

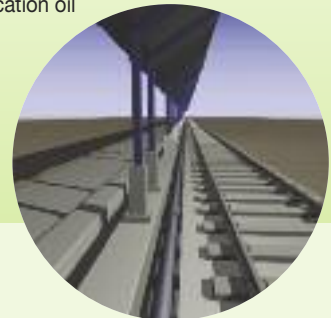

Haulage or Distribution Centres

PLX is suitable to convey a wide range of fuels including petrol, diesel, biofuels and AdBlue®. The added protection of the Secondary Containment pipework provides a leak tight system suitable for high-speed suction or pumped applications.



Marinas

PLX Secondary Contained pipework provides a secure environment for bulk transfer of marine fuels to storage tanks, during vessel refuelling, bunkering and bilge water pumping operations. PLX Pipe-In-Pipe systems are corrosion, UV and abuse resistant ensuring outdoor weathering does not penetrate the pipework system. With a high resistance to marine fuel oils, PLX is a cost-effective solution for marine related fuel transfer.



Tunnels

PLX is suitable for use as drainage pipework for tanker spillages. Installations are situated under all road tunnels. Through kerb drainage systems, PLX can be connected safely and transfer these mixed chemical fluids through to separators and other storage facilities.



Tank Chamber Connection (UST)

The tank chamber is central to the forecourt fuel system, it provides inspection access to the tank and protects the pipe and pump connections. With space at a premium the innovative design of PLX electrofusion demountable compact flanges helps to minimise installation time and ensures easy access to the tank connections.

Available products are PLX Secondary Containment pipe, electrofusion elbows, couplers, tees and transition fittings.



Offset Fill & Vent

Specifically designed PLX Fill & Vent pipe reduces time and costs when filling underground fuel storage tanks. PLX Fill & Vent is also suitable for venting the system to ensure the tank and associated pipework are pressure balanced.

An 'offset fill' is used for filling each of the underground tanks. With minimal available gravity head, frictional losses must be considered. Even though operating under gravity head, fill pipe should be considered as a pressure system and can be installed using PLX secondary contained systems.

Typical sizes used for this application are 63mm, 90mm and 110mm. Available products are PLX and PLX Fill & Vent pipe, electrofusion elbows, couplers, tees and transition fittings for safe connection to the offset fill and storage tank.

Vent equipment ensures the safe holding and balancing of vapour control of the underground storage tanks. Vents and vapour recovery systems ensure that Underground Storage Tanks (USTs) and associated pipework are pressure balanced and that air and fuel vapour are safely recovered.



Transport Refuelling Installation

These installations could be trenching or require pipework to be situated within a duct. Please refer to the Installation guidelines and contact our Technical Support Team if you require further information.



Connection to System Apparatus

PLX Transition fittings ensure the safe continuous flow of fuel when connecting to metal threaded system apparatus. Each transition fitting has been innovatively designed and manufactured using the highest quality PE and a wide range of metals. With the process of installation in mind; each fitting is developed to save time and costs during the installation process.



General Information

Health & Safety

Durapipe PLX products have been installed and used safely in large volumes over many years. However, good working practice is vital in ensuring safety; our products should be handled and processed in accordance with the British Plastics Federation guidelines. All pipe systems contain trace quantities of process residues and may also contain other materials such as pigments, antioxidants and UV stabilisers. Chemically unreactive, PE is regarded as being biologically inert.

Inhalation

PLX does not release harmful fumes at ambient temperature.

The threshold limit value for PE dust is 10mg/m³ (8 hour time weighted average in the working environment), but the generation of such levels when working with PE pipe and/or fittings is extremely unlikely.

Physical contact

PE is not considered to be a skin irritant. Where PE dust is generated by cutting particles of PE, dust may cause eye irritation.

Fire Characteristics

When PE is heated in air, melting will occur at 120-135°C and decomposition will commence at approximately 300°C. Above this temperature PE will pyrolyse oxidatively to produce carbon dioxide, carbon monoxide, water and various hydrocarbons. These gases may ignite and provide heat that may accelerate the pyrolysis of more PE in the vicinity. In burning, molten droplets of material may be released which could ignite adjacent inflammable materials. Combustion of PE may release toxic materials - Avoid inhalation of smoke or fumes.

Electrofusion Jointing

During the electrofusion welding of PLX fittings molten PE is formed at the pipe/fitting joint interface.

If this molten material is allowed to contact the skin, it will adhere strongly and cause severe burns. Appropriate PPE must be used at all times.

Small quantities of fumes may be given off by molten PE – these are more pronounced at higher temperatures. In confined spaces ventilation must be provided to ensure safe working conditions.

Handling and Storage

PLX pipe and fittings are resilient, lightweight and easy to handle. Nonetheless, care must be taken not to cause excessive scuffing or gouging of the surface of the pipe. In addition to the guidelines set out below, the handling and storage of PLX pipes is covered by the codes of practice issues in the IP specification for Underground Pipework Systems.

Handling

PLX Straight Length Pipes

A flat bed vehicle, free from sharp objects and projections should be used for the transportation of PLX pipe systems. When lifting pipe bundles by crane, wide polypropylene slings must be used. Do not use chains, hooks or hawsers. When lifting pipe bundles containing pipe lengths greater than six metres a load, a spreading beam should be used.

Allow for a certain degree of deflection or slight bending of the pipe bundles when loading or unloading. Standard six metre bundles may be handled using a forklift, but longer lengths should be moved using a side loader fitted with a minimum of four supporting forks, or using a crane fitted with a spreader beam.

PLX Coils

PLX coils of small diameter pipes can be easily manhandled. Where forklifts are used to off load coils of larger diameter pipe, the forks should be protected to avoid damaging the outer surfaces of PLX pipe. Standing PLX coils upright will create excessive point loads that, on loose ground can cause serious or irreparable damage to PLX primary or secondary pipe.

Releasing Coils

Pipe held in coils is under tension and during manufacture is strapped accordingly. Dependent on the pipe size and coil length, coiled pipes are secured in layers or parts of and must be released in the correct order. Generally, coils should be released only as the pipe is withdrawn for use. In all cases the pipe end must be restrained at all times.

Storage

Badly stacked coils or bundles of pipe may slip or collapse causing injury to personnel as well as damage to the product.

PLX Straight Length Pipes

PLX pipe lengths stored individually should be stacked in a pyramid not more than one metre high with the bottom layer fully restrained by wedges/side supports. To avoid load damage and distortion pipes should be stored in their original packaging, off the ground and the bottom layer of pipes laid on levelled timber battens spaced at one metre centres.

Pipes of only one size should be stored in each pyramid and individual lengths should not be allowed to cross one another.

Pipe Crates and Pipe Bundled Packs

Bundled packs or crates should be stored on clear, level ground with battens supported by timbers. Bundled packs and crates should never be stacked more than three high or maximum of three metres.

PLX Coils

PLX pipe coils should be stored flat on firm level ground and supported on timber battens to protect the bottom of the coil. Point loads caused by the pipes being stored upright or rolled should be avoided.

Facilities for safe lifting, movement and loading/unloading must be available. Pipe coils should not be rolled.

PLX Pipe Fittings

PLX Electrofusion and spigot fittings are individually packed in heat sealed 400g polythene bags. Factory packed for maximum protection against contamination, the fittings should be stored in their original packaging in dry secure conditions and selected for use in stock rotational order.

The fittings individual packaging should be retained until immediately prior to installation and any unused fittings should be re-bagged immediately. Prior to these fittings being used in the future, electrofusion sockets and prepared spigot fittings should be cleaned using Durapipe Isopropanol wipes.

Durapipe PLX Piping System - Warranty

Save for its statutory liabilities the following constitutes the sole and exclusive obligations of Glynwed Pipe Systems Ltd trading as Durapipe UK to the Distributor or any person acquiring title through the Distributor, is in lieu of all other warranties, expressed and implied, and there are no implied warranties of merchantability or fitness for particular purpose, except as follows:

- A. Durapipe UK warrants that the PLX Underground Piping System will meet its published specifications, and will be free from material defects in materials and workmanship, under normal use and maintenance, for a period of fifteen years from the date of installation.
- B. Each such warranty, as described above, is subject to the following conditions and limitations:
- 1) The PLX Underground Piping System must be installed in accordance with Durapipe UK published installation instructions and in accordance with prevailing government regulations and codes and must be used in accordance with Durapipe UK specifications.
 - 2) The PLX Underground Piping System must be used exclusively for petrol and diesel fuel.
 - 3) The PLX Underground Piping System must be comprised solely of Durapipe UK pipes, fittings and accessories and must be jointed using the specified PLX equipment.
 - 4) All of the warranties described above shall apply to the original installation only.
 - 5) Durapipe UK shall not be liable for damage to or defects in any products caused by improper transportation, storage or other misuse, neglect or accident, nor does this warranty apply to any products which have been repaired or altered in any way which, in the sole judgement of Durapipe UK, affects the performance, stability or general purpose for which they are manufactured.
- C. GLYNWED PIPE SYSTEMS LTD LIABILITY UNDER THIS WARRANTY SHALL BE LIMITED TO:
- 1) Liability for death or personal injury resulting from its negligence.
 - 2) At its option either:
 - a) the repair of the defective Durapipe UK components of the PLX Underground Piping System;
 - b) the replacement of the defective Durapipe UK components of the PLX Underground Piping System; or
 - c) refund of the purchase price of the PLX Underground Piping System as charged to the Distributor.

Note: Durapipe UK shall not be liable for labour or other installation or replacement costs incurred in connection with the replacement products furnished in accordance with the terms of this warranty, nor shall Durapipe UK be liable for the costs of removal or re-installation of any product.

- 3) Liability for direct damage to material property as a result of a sudden and accidental discharge or dispersal of fuel directly caused by a defect in the Product. Under no circumstances shall Durapipe UK liability under this clause exceed £5 million for an event or a series of events.

Durapipe UK Pipework Systems

INDUSTRIAL



ABS

- Ideal for chilled, potable and waste water
- Tough, durable, lightweight and fully approved
- Suitable for use from -40°C to +70°C
- Fully matched system of pipes, fittings and valves



PVC-U

- Versatile, multi-purpose solvent weld pipework system with an extensive range of valves and fittings
- The established system for process and industrial handling of chemicals and water up to 60°C



Guardian

- Specialist dual contained pipework
- Patented Centra-Lok™ system
- Visual or automated leak detection system available



Air-Line Xtra

- High performance thermoplastic pipework system for compressed air



Polypropylene

- Conveys chemicals at temperatures up to 100°C
- Excellent resistance to a wide range of substances
- Available in larger diameters up to 500mm



Corzan

- Solvent weld thermoplastic pipe system for aggressive substances
- Designed specifically for use in highly corrosive conditions at temperatures up to 95°C
- Valves range available



Flow Control

- Manual and actuated flow control solutions
- For use with all Durapipe systems
- Lightweight and easy to install

BUILDING SERVICES



Vulcathene

- Safe chemical drainage pipework
- Two easy jointing methods - Mechanical or Enfusion
- Ideal for schools, universities and colleges, hospitals and clinics



Friaphon

- Sound attenuated drainage system
- Superb sound insulation with no lagging required
- Ideal for hospitals, hotels, office suites and apartments



Duracool

- Pre-insulated ABS pipework system
- Lightweight and easy to install
- Unique shells for cost-efficient installation



Superflo

- Pipe system for chilled and cold water applications
- Ductile and robust down to minus 40°C
- Lightweight, non-corrosive and limescale resistant



Friatherm

- Limescale and corrosion resistant
- WRAS Approved
- Installed cost saving versus traditional materials

Notes

DURAPIPE UK CONDITIONS OF SALE

1. **DEFINITIONS:**
'Seller' shall mean Glynwed Pipe Systems Limited, registered in England under number 1698059. 'Buyer' shall mean any company, organisation or individual to whom a quotation is offered, or whose order is accepted by the Seller.
2. **CONDITIONS:**
All offers, quotations, estimates, acceptances and contracts are subject to these Conditions of Business and any terms or conditions which any other person shall seek to impose or make part of any contract shall, so far as is inconsistent with these Conditions of Business, not apply unless expressly agreed by the Seller in writing. The headings in these conditions are for convenience only and shall not affect their interpretation.
3. **QUOTATIONS AND PRICE VARIATION:**
 - a) Any quotation given by the Seller is an invitation to the Buyer to make an offer only and no order of the Buyer placed with the Seller in pursuance of a quotation or otherwise shall be binding on the Seller unless and until it is accepted in writing by the Seller.
 - b) Unless stated otherwise, all quotations and published price lists are ex works, exclusive of VAT and shall remain valid for 30 days or such a period as may be quoted but nevertheless the Seller may amend or withdraw any quotation by written or oral notice. Quotations may be varied if the Buyer makes variations in his specifications.
4. **STATEMENTS OR REPRESENTATIONS TO THE BUYER:**
If any statement or representation has been made to the Buyer upon which the Buyer relies other than in the documents enclosed with the Seller's quotation, the Buyer must set out that statement or representation in a document to be attached to or endorsed on the order in which case the Seller may submit a new quotation.
5. **DELIVERY - TIME:**
 - a) Any period for delivery given at any time and in any manner by the Seller is an estimate only and is not binding on the Seller. Delivery periods are normally calculated from the later of:
 - i) acceptance of order; or
 - ii) where applicable, the receipt by the Seller of a detailed specification or drawings.
 - b) Time shall not be deemed to be of the essence of the contract. Failure by the Seller to meet any quoted delivery period for any part or the whole of the order shall not entitle the Buyer to rescind the contract or to claim damages of any nature.
 - c) The Seller will endeavour to comply with reasonable requests by the Buyer for postponement of delivery but shall be under no obligation to do so. Where delivery is postponed otherwise than due to default by the Seller the Buyer shall pay all costs and expenses including a reasonable charge for storage and transportation occasioned thereby and an extra charge for split delivery if applicable.
 - d) The Buyer will receive delivery of any consignment between the hours of 8.00am and 4.00pm Monday to Friday inclusive, unless otherwise agreed in writing. Cost incurred by the Seller arising from the Buyer's refusal to accept consignments within the agreed hours shall be borne by the Buyer.
6. **DELIVERY AND RISK:**
 - a) Except where stated to the contrary in the contract, delivery shall be made as follows:
 - i) where the Buyer provides the transport, delivery shall be made ex the Seller's works;
 - ii) where the Seller provides the transport, delivery shall be made to the premises of the Buyer, or the premises of the Buyer's customer or works site if the Buyer has requested delivery to be so made but where the Buyer has made such a request the Seller will make a first delivery to the Buyer's customer or works site as so much of the goods as is available for that delivery but subsequent deliveries will be made to the premises of the Buyer.
 - b) The Seller may at its discretion make partial delivery of orders and invoice the same.
 - c) Risk in the goods shall pass on delivery.
 - d) Where goods are sent FOB the Seller's responsibility shall cease when the goods are placed on board ship or aircraft without the need for the Seller to give notice to the Buyer and the provisions of Section 32(3) of the Sale of Goods Act 1979 shall not apply.
7. **OWNERSHIP OF GOODS:**
 - a) The goods shall remain the sole and absolute property of the Seller as legal and equitable owner until such time as the Buyer shall have paid to the Seller the contract price together with the full price of any other goods the subject of any contract between the Seller and the Buyer.
 - b) The Buyer acknowledges that until such time as the property in the goods passes to the Buyer he is in possession of the goods as a bailee and fiduciary agent for the Seller and the Purchaser shall store the goods in such a manner that they are clearly identifiable as the property of the Seller.
 - c) Until payment due under all contracts between the Buyer and the Seller had been made in full, in the event of sale of the goods by the Buyer:
 - i) the Seller shall be entitled to trace all proceeds of sale received by the Buyer through any bank or other account maintained by the Buyer; and
 - ii) the Buyer shall if requested by the Seller in writing to so assign its rights to recover the selling price of the goods from the third parties concerned. Such monies to be held separately by the Buyer as agent on behalf of the Seller.
 - d) The Seller may for the purpose of recovery of its goods enter upon any premises where they are stored or where they are reasonably thought to be stored and may repossess the same.
8. **TERMS OF PAYMENT:**
In the event of default in payment according to the agreed payment terms between the Seller and the Buyer – ie: by the end of the month following the month of despatch of the goods the Seller shall be entitled without prejudice to any other right or remedy to suspend all further deliveries and to charge interest on any amount outstanding at the rate of 2% per month until payment in full is made (a part of a month being treated as a full month for the purpose of calculating interest).
9. **SHORTAGES AND DEFECTS APPARENT ON DELIVERY:**
 - a) It shall be the responsibility of the Buyer to inspect or arrange for an inspection of the goods on delivery whether the goods are delivered to the Buyer's premises or to the premises of the Buyer's customer or to a works site. If no such inspection is made the Buyer shall be deemed to have accepted the goods.
 - b) The Buyer shall have no claim for shortages or defects apparent on inspection unless:
 - i) a written complaint is made to the Seller within three days of receipt of the goods specifying the shortage or defect; and
 - ii) the Seller is within seven days of receipt of the complaint given an opportunity to inspect the goods and investigate the complaint before any use is made of the goods.
 - c) If a complaint is not made to the Seller as herein provided then in respect of such shortages or defects the goods shall be deemed to be in all respects in accordance with the contract and the Buyer shall be bound to pay for the same accordingly.
10. **CLAIMS FOR DEFECTS NOT APPARENT ON INSPECTION:**
 - a) The Buyer shall have no claim for defects not apparent on inspection unless the Seller is notified of defective workmanship or materials within twelve months from delivery of the goods. Provided that the goods have been installed and applied in accordance with any relevant recommendations made by the Seller, the Seller will at its option replace the goods or refund the net invoiced price in respect of the goods which have been shown to be defective. If the Seller does so supply substitute goods the Buyer shall be bound to accept such substituted goods in full satisfaction of the obligations of the Seller under the contract.
 - b) The Buyer shall in any event have no claim or set-off in respect of defects unless a written complaint is sent to the Seller as soon as the defect is noticed and no use is made of the goods thereafter or alteration made thereto by the Buyer before the Seller is given an opportunity to inspect the goods.
 - c) The Buyer is responsible for ensuring that the goods are fit for any particular purpose, and no warranty or condition of fitness for any particular purpose is to be implied into the contract.
11. **LIABILITY:**
Save as stated in Conditions 9 and 10 (and save in respect of death or personal injury resulting from the negligence of the Seller its servants or agents) the Seller shall not be liable for any claim or claims for direct or indirect consequential or incidental injury loss or damage made by the Buyer against the Seller whether in contract or in tort (including negligence on the part of the Seller its servants or agents) arising out of or in connection with any defect in the goods or their fitness or otherwise for any particular purpose or any act omission neglect or default of the Seller its servants or agents in the performance of the contract.
12. **FORCE MAJEURE:**
Notwithstanding anything herein contained neither the Buyer nor the Seller is to be held liable for any delay or failure to carry out the contract due wholly or in part to an act of God action by any Government whether British or foreign civil war strikes and/or lockouts wheresoever occurring fire trade disputes floods or unfavourable weather or any material becoming unavailable or irreplaceable (whether at all or at commercially acceptable prices) or any other circumstances beyond the control of the Seller.
13. **SUB-CONTRACTING:**
The Seller reserves the right to sub-contract the fulfilment of any order or any part thereof.
14. **INSOLVENCY AND BREACH OF CONTRACT:**
In the event that:
 - a) the Buyer commits any breach of the contract and fails to remedy such breach (if capable of remedy) within a period of thirty days from receipt of a notice in writing from the Seller requesting such remedy; or
 - b) any distress or execution is levied upon any of the goods or property of the Buyer; or
 - c) the Buyer offers to make any arrangements with or for the benefit of its creditors or (if an individual) becomes subject to a petition for a bankruptcy order or (being a limited company) has a receiver appointed of the whole or any part of its undertaking property or assets; or
 - d) an order is made or a resolution is passed or analogous proceedings are taken for the winding up of the Buyer (save for the purpose of reconstruction or amalgamation with insolvency and previously approved in writing by the Seller) the Seller shall thereupon be entitled without prejudice to its other rights hereunder forthwith to suspend all further deliveries until the default has been made good or to determine the contract and any unfulfilled part thereof or at the Seller's option to make partial deliveries. Notwithstanding any such termination the Buyer shall pay to the Seller at the contract rate for all the goods delivered up to and including the date of termination.
15. **INDUSTRIAL PROPERTY RIGHTS:**
If goods supplied by the Seller to the Buyer's design or specifications infringe or are alleged to infringe any patent or registered design right or copyright the Buyer will indemnify the Seller against all damages, costs and expenses incurred by the Seller as a result of the infringement or allegation. The Buyer will give the Seller all possible help in meeting any infringement claim brought against the Seller.
16. **BUYER'S ERROR IN ORDERING:**
In the event the Buyer orders incorrectly the Seller will be under no obligation to the Buyer to rectify or assist in rectifying the error.
17. **LAW AND JURISDICTION:**
The contract shall be subject in all respects to English Law and to the jurisdiction of the English Courts.

Standards and Approvals

Durapipe UK high performance plastic pipework systems are lightweight and easy to install whilst having excellent corrosion and limescale resistance properties.

Durapipe UK products are manufactured to the highest level and meet the requirements of many international standards and approvals.

Furthermore, our products are manufactured in an environment that complies with the requirements of ISO 9001 and ISO 14001.

Durapipe UK reserves the right to modify the details in this publication as products and specifications are updated and improved. The content of this publication is for general information only and it is the user's responsibility to determine the suitability of any product for the purpose intended.

For further information on all Durapipe products and services contact our Customer Services Team on +44 (0)1543 273100 or fax +44 (0)1543 279450.

Durapipe UK is a trade name of Glynwed Pipe Systems Ltd. Company Number 1698059.

Registered office:

Durapipe UK

Walsall Road
Norton Canes
Cannock
Staffordshire
WS11 9NS
United Kingdom
Tel: +44 (0)1543 273100
Fax: +44 (0)1543 279450
email: enquiries@durapipe.co.uk
web: www.durapipe.co.uk



Certificate no. FM34819

Distributor

04900110 February 2011

an *Aliaxis* company

Fibre Glass Piping Systems

NOV Fibre Glass Systems is the combination of the star™ Fibreglass product line and the Smith Fibrecast® product lines, bringing over 60 years of “time-tested” composite pipe experience to the Oilfield, Chemical/Industrial, Petroleum Marketing, and Marine and Offshore markets. Our broad range of temperatures, pressures and corrosion barriers allow us to best match a product with your application.

Oilfield

NOV Fiber Glass Systems is a leading worldwide manufacturer of fiberglass reinforced epoxy products used for onshore and offshore corrosion control in a variety of low to high pressure oilfield applications. Fiber Glass Systems was founded in 1968 in Big Spring, Texas, the center of the United States oil and gas production industry, and focused on developing products for applications in this oil and gas sector. Our signature patented connection, Advanced Composite Thread (ACT), is regarded as one of the best connections for high pressure line pipe in the industry. Additionally, this threaded connection has excellent make-up and breakout performance for downhole tubing. Our low pressure product line consists of **Star Super Seal, Red Thread®** and **Red Thread II** pipe and fittings installed in oil fields all over the world.



Chemical & Industrial

For over 60 years NOV Fiber Glass Systems has been the industry leader in Chemical & Industrial corrosion resistant piping systems. The combination of the Fibrecast family of products for chemical process and chemical handling lines and the Smith family of products for light duty chemical and water provides the broadest array of epoxy and vinyl ester piping systems in the world. Our long-term commitment to product innovation and compliance with recognized industry standards makes NOV Fiber Glass Systems the engineer's choice.



Fibre Glass Piping Systems

Marine & Offshore

NOV Fiber Glass Systems designed and engineered high performance pipe and fittings specifically for the demanding requirements of offshore platforms and onboard ship systems. Rigid industry standards set by the International Maritime Organization (IMO) and specific 3rd party approvals guarantee that system performance is never compromised. The ability to meet these high standards is backed by ongoing in-house testing. Commitment to engineering and design capabilities ensure compliance and performance by **Green Thread 175** and **Green Thread 250** series piping. Design, quality, engineering, service and commitment make NOV Fiber Glass Systems the global choice.



Petroleum Marketing

NOV Fiber Glass Systems is the market leader for “time-tested piping systems” for underground fuels (downstream market segment). This is proven by 40 years of continuous supply of UL Listed products for underground fuels through a Global Distributor network. **Red Thread, Red Thread II** and **Red Thread IIA** pipes have never been removed due to fuel incompatibility. With the constant search for renewable fuels, this long-term capability is key to our product use for future fuel applications.



Vacuum Leak Detection

Underpressure leak detector VLR 410/E



weatherproof design

An underpressure leak detector for the continuous monitoring of double walled pipes

Each leak in one of the both walls will be detected, before conveyed product will enter the environment.

A leak detection system with the highest environmental protection level in accordance to the European standard EN 13160.

Liquids to be monitored

Water polluting liquids:

- with a flash point above $> 55^{\circ}\text{C}$, without potentially explosive vapours; e.g.: diesel

For the monitoring of pipes:

Approved and made out of metal or plastic

- up to 25 bar pressure in the primary pipe

Approval:

Germany: Z – 65.25 – 390

Type	Alarm ON	Pump OFF
VLR 410/E	$> 410 \text{ mbar}$	$< 540 \text{ mbar}$

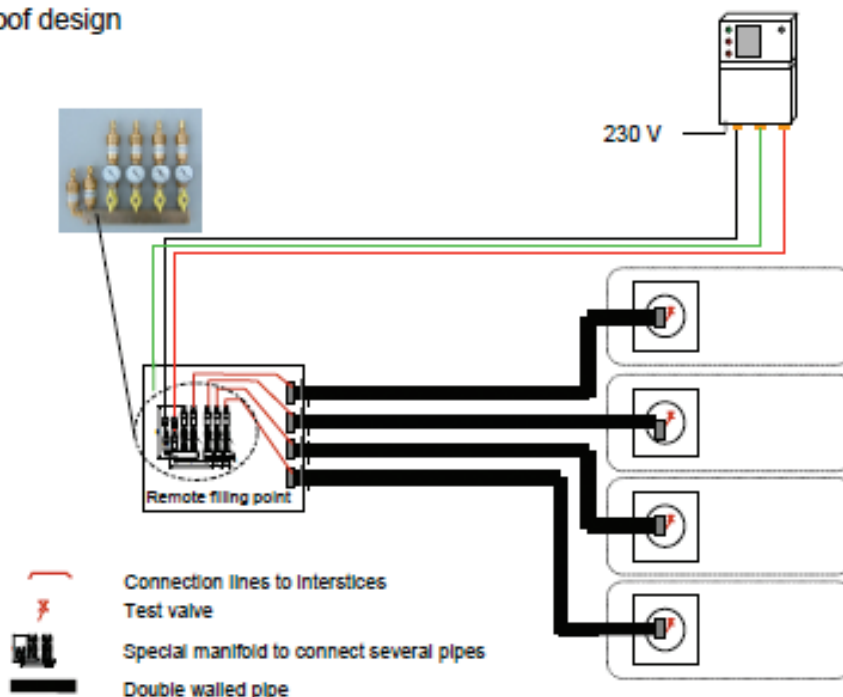

Underpump Containment Systems

Shipman King provides a simple and effective form of underpump containment sumps for pressure or suction systems to meet today's environmental requirements. The sumps provide pollution/spill control protection for fuel dispensers and fittings, located above or within the containment sump.

Our sumps are completely manufactured in Australia to meet Australian conditions, and are produced in medium density polyethylene.

The sumps are supplied completely assembled with a galvanised steel base to suit the various pumps and dispensers on today's market. The underpump sumps can be manufactured in either a shallow or deep configuration.

To assist with ease of installation, all dispenser bases are provided with shear valve mounting bars which are adjustable in all directions to allow for accurate alignment.

To compliment our underpump containment sumps, a range of flexible entry seals are supplied and marketed by Shipman King to suit most sizes of flexible and solid piping, including electrical conduit.

To identify containment sumps required for your installation, refer to our dispenser and pump directory.

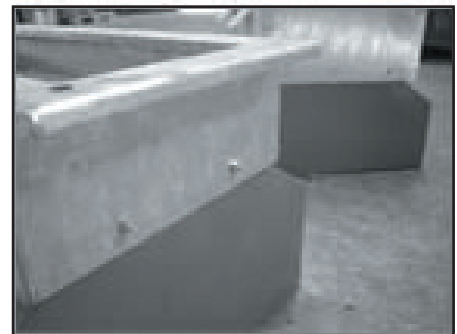
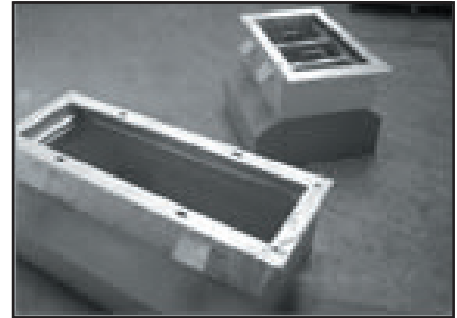

Underpump Containment Sump Features

1. Shipman King pump and dispenser bases are manufactured specifically to suit the type of pump or dispenser specified.
2. Bases are manufactured out of steel pressings or steel angle.
3. Lugs are welded to each base to ensure the base is adequately keyed into the concrete.
4. Bases are hot dipped galvanised after manufacture.
5. Dispenser bases have shear valve mounting bars that can be adjustable in three directions for accurate alignment.
6. Slotted holes for holding down bolts allows for easy fitting of the pump or dispenser to the bases.
7. Shipman King underpump containment sumps come complete with the base fixed to the polyethylene sump for ease of installation.
8. The polyethylene sumps are moulded in a number of sizes and shapes to accommodate the various pumps and dispensers.
9. A number of polyethylene sumps are available in two depths, shallow or deep. Consult the dispenser and pump directory on the following pages for more information.
10. The depth of certain polyethylene sumps can be adjusted by simply cutting the polyethylene sump down and re-fixing the frame to the sump.
11. Shipman King underpump containment sumps are suitable for both flexible and solid piping.
12. Our underpump sumps and bases can also be used under LPG dispensing units.

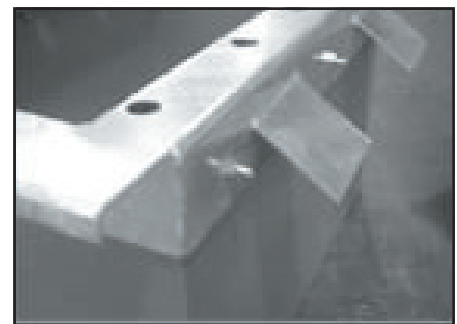
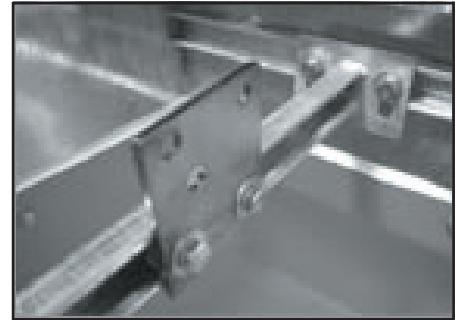

Underpump Containment Sump Dispenser & Pump Directory

Description	Product Number	Depth (mm)
Gilbarco Hi-Line - MPP 4 & 6 Hose Suction System	PUPGHSS46 PUPGHSS46-D	500 800
Gilbarco Hi-Line - MPD 4 & 6 Hose Pressure System	PUPGHPS46 PUPGHPS46-D	500 800
Gilbarco Low-Line - MPP 2 & 4 Hose Suction System 2 & 4 Hose Pressure System Short Base Frame	PUPGLSS4 PUPGLPS4	600 700
Gilbarco Low-Line - MPP 4 & 6 Hose Suction System Long Base Frame	PUPGLSS6 PUPGLSS6-D	450 700
Gilbarco Low-Line - MPP 4 & 6 Hose Pressure System Long Base Frame	PUPGLPS6 PUPGLPS6-D	550 800
Gilbarco Electroline Single & Duel Suction System Single & Duel Pressure System	PUPGESS12 PUPGEPS12	450 560
Gilbarco Fleetline Single & Duel Suction System	PUPGFSS	450
Gilbarco Enterprise - Narrow 2 & 4 Hose Suction System 2 & 4 Hose Pressure System	PUPGENSS PUPGENPS	600 700
Gilbarco Enterprise - Wide Suction System Pressure System	PUPGEWSS PUPGEWPS	700 800
Gilbarco Low-Line - Mark 3 Pressure System	PUPGLM3PS PUPGLM3PS-D	550 800
Gilbarco SK700 2 Hose Pressure System	PUPGSK702P	560
Gilbarco SK700 4 Hose Pressure System	PUPGSK704P	800
Gilbarco SK700 6 Hose Pressure System	PUPGSK706P	800
Gilbarco SK700 8 Hose Pressure System	PUPGSK708P	800
Email Vision 2 & 4 Hose Suction System 2 & 4 Hose Pressure System	PUPEVSS PUPEVPS	550 550
Email Pacesetter Single & Duel Suction System Single & Duel Pressure System	PUPEPSS12 PUPEPPS12	450 550
Compac Laser Suction System Pressure System	PUPCLSS PUPCLPS	550 550

Underpump Containment Sump Dispenser & Pump Directory

PEC8000 4 & 6 Hose Suction System	PUPP8SS46 PUPP8SS46-D	500 800
PEC8000 4 & 6 Hose Pressure System	PUPP8PS46 PUPP8PS46-D	500 800
PEC9000 4 & 6 Hose Suction System	PUPP9SS46 PUPP9SS46-D	500 800
PEC9000 4 & 6 Hose Pressure System	PUPP9PS46 PUPP9PS46-D	500 800
PEC9000 Short Base 4 & 6 Hose Suction System	PUPP9SSSH PUPP9SSSH-D	500 800
PEC9000 - Mini 2 & 4 Hose Suction System	PUPP9SS24	550
CEEPEC Single & Duel Suction System Single & Duel Pressure System	PUPCESS12 PUPCEPS12	450 560
Email Low-Line - MPP 4 & 6 Hose Suction System	PUPESS24 PUPESS24-D	500 800
Email Low-Line - MPD 4 & 6 Hose Pressure System	PUPEPS24 PUPEPS24-D	500 800
Email Long Base - MPP 6 Hose Suction System	PUPESS6	550
TT 805 Suction System Pressure System	PUPT805SS PUPT805PS	550 550

** The above directory identifies a number of dispensers and pumps that are currently on the market. This list is by no means complete due to the wide range of dispensers and pumps available. If you require information on a dispenser or pump that is not listed, please contact Shipman King or the Distributor in your state.

■ Eskay Transition Sumps

The Eskay Transition Sumps come in a number of sizes complete with non load bearing aluminium floor plate lids. Using our unique polyethylene sumps and galvanised frames the transition sumps are ideal for accessing change in pipe directions, valves or termination of pipe lines.

Product Number

PUPTS560

PUPTS790

PUPTS1140

Dimensions (mm)

560mm X 390mm X 600mm Deep

790mm X 690mm X 600mm Deep

1140mm X 690mm X 700mm Deep

Load bearing lids can be supplied if required.



Screwseal for Conduit (2" Hole Saw)

Screwseal

The screwseal entry boots are manufactured by Diversified Products Inc., a leading supplier of this equipment in the U.S.A. The screwseals are compatible with all fuels, are U.L. listed and provide a quick and simple sealing arrangement for pipes or conduits penetrating underpump sumps or manhole risers.

Use With

1/4" Cable Insert
1/2" Rigid Conduit
3/4" Rigid Conduit
1" Rigid Conduit
1 1/2" Rigid Conduit

Product No.

SS1025IN
SS1050
SS1075
SS1100
SS1125



SS1075

Screwseal for Pipe (5" Hole Saw)

Use With

1 1/2" Pipe - flat surface
1 1/2" Pipe - curved surface
2" Pipe - flat surface
2" Pipe - curved surface
2 1/2" Pipe - flat surface
2 1/2" Pipe - curved surface
3" Pipe - flat surface
3" Pipe - curved surface

Product No.

SS1150F
SS1150C
SS1200F
SS1200C
SS1250F
SS1250C
SS1300F
SS1300C



SS1200C

Reducing Boots with Test Port

Use With

40mm Pipe to 32mm Pipe

63mm Pipe to 50mm Pipe

75mm Pipe to 63mm Pipe

Product No.

SS4032

SS6350

SS7563



Boltseal for Pipe

Use With

2" Pipe
2.5" Pipe
3" Pipe
4" Pipe
6" Pipe

Product No.

SS1200B
SS1250B
SS1300B
SS1400C
SS1600B



SS1400C

Browning Spill Safe Boxes - Patent No. 625663

Browning Spill Safe Boxes Features

1. Steel frame constructed of steel plate for added strength.
2. Steel lids are manufactured from floor plate with D-style handles. The lids are hinged using a stainless steel hinge pin which can be removed if required.
3. The inner catchment sumps are manufactured of mild steel plate for a strong and sturdy construction. The inner lids stop any dust and dirt from entering the catchment sump.
4. The catchment sumps are formed to ensure all spillage flows to the drain point.
5. All steelwork is hot dipped galvanised.
6. The catchment sump is attached to the steel frame by nuts and bolts. This allows access to be obtained to the fill lines after concreting, if required, by undoing the nuts and bolts and lifting the catchment sump out of the steel frame.
7. The Browning Spill Safe box is designed for either 100mm fill lines or 75mm fill lines. The standard fill pipe centres on the Browning Spill Safe box is 400mm, however the spill safe box can be built to suit your retrofit requirements.
8. Fill pipes are sealed by a fuel compatible boot. Viton Boots are also available for 100mm fill pipes if required.
9. A valve with viton seal is screwed into the drain point. The valve is activated by pushing down on the handle with either the foot or hand.
10. The drain valve is connected back to any of the fill points by using the stainless steel flexible valve connector and the 100mm or 75mm socket provided. This enables the spillage to be returned to the designated product line.
11. Earthing straps are fitted to all Spill Safe boxes.
12. The Browning Spill Safe Boxes can also be supplied with individual catchment sumps to ensure no product contamination occurs. These sumps come complete with individual drain valve, flexible valve connector and gal steel socket.
13. All Browning Spill Safe boxes come with a 12 month warranty period when installed as per installation instructions and are covered by Shipman King's product liability insurance.
14. When ordering please advise the following:
 - 100mm or 75mm Boots
 - Earthing kit (Extra)
 - Gal Steel Elbow (Extra)

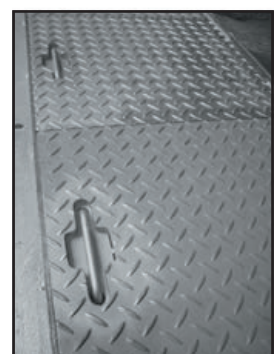
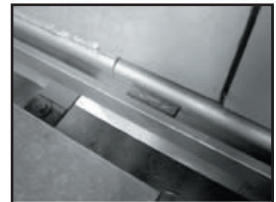

Browning Spill Safe Boxes - Patent No. 625663

15. Standard Spill Boxes

Product Number	Description	Dimensions (mm)
MBXBSS-1	Single Fill Point	500 X 490 X 250
MBXBSS-1VR	Single Fill Point + VR	820 X 490 X 250
MBXBSS-2	2 Fill Point	820 X 490 X 250
MBXBSS-2VR	2 Fill Point + VR	1220 X 490 X 250
MBXBSS-3	3 Fill Point	1220 X 490 X 250
MBXBSS-3VR	3 Fill Point + VR	1620 X 490 X 250
MBXBSS-4	4 Fill Point	1620 X 490 X 250
MBXBSS-4VR	4 Fill Point + VR	2020 X 490 X 250
MBXBSS-5	5 Fill Point	2020 X 490 X 250
MBXBSS-5VR	5 Fill Point + VR	2420 X 490 X 250
MBXBSS-6	6 Fill Point	2420 X 490 X 250
MBXBSS-6VR	6 Fill Point + VR	2820 X 490 X 250
MBXBSS-7	7 Fill Point	2820 X 490 X 250
MBXBSS-7VR	7 Fill Point + VR	3220 X 490 X 250

16. Individual Inner Catchment Sumps

Product Number	Description	Dimensions (mm)
MBXBIS-2	2 Fill Point	820 X 490 X 250
MBXBIS-2VR	2 Fill Point + VR	1220 X 490 X 250
MBXBIS-3	3 Fill Point	1220 X 490 X 250
MBXBIS-3VR	3 Fill Point + VR	1620 X 490 X 250
MBXBIS-4	4 Fill Point	1620 X 490 X 250
MBXBIS-4VR	4 Fill Point + VR	2020 X 490 X 250
MBXBIS-5	5 Fill Point	2020 X 490 X 250
MBXBIS-5VR	5 Fill Point + VR	2420 X 490 X 250
MBXBIS-6	6 Fill Point	2420 X 490 X 250
MBXBIS-6VR	6 Fill Point + VR	2820 X 490 X 250
MBXBIS-7	7 Fill Point	2820 X 490 X 250
MBXBIS-7VR	7 Fill Point + VR	3220 X 490 X 250

Browning Secondary Contained Spill Box

With secondary contained fill lines becoming more popular, Shipman King has come up with a solution to not only have access to terminate the fill pipes but also to incorporate our popular Browning Spill Box with a secondary contained sump. Manufactured from fibreglass, the sump sits under the Browning Spill Box to further ensure any spills do not leak into the ground below.

Shipman King can also supply this Sump and Spill Box prefabricated with the fill pipes protruding outside the fibreglass sump ready to be hooked up to on site. This is just another way Shipman King can help you save time and money with your on site works.

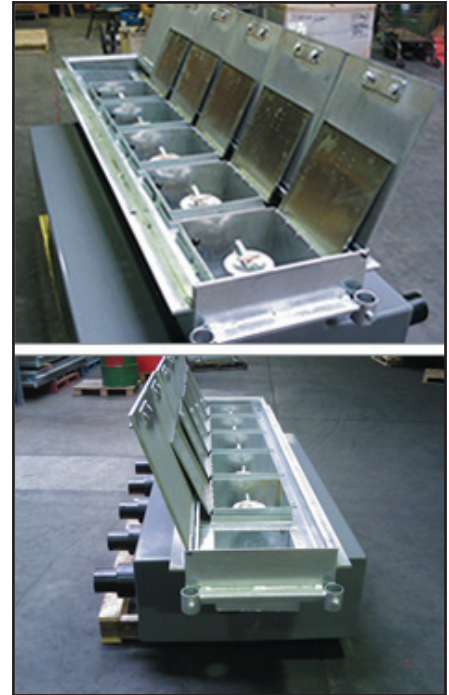

Emco Wheaton Single Point Spill Box

The Emco Wheaton Replaceable Direct Bury Spill Containment is a single point spill box that is easy to install and has been designed to allow the primary unit to be replaced without breaking concrete. The Spill Containment boxes screw directly onto the 4" riser pipe and are approx 450mm deep.

Features include: stainless steel bolts, galvanised steel gravel guard, HDPE bellows and ductile iron lid and rim.

Product Number

MBXEMCO



Valve Manifold Boxes

Product Number

MBXVM500
MBXVM900
MBXVM1200
MBXVM1600
MBXVM2000

Description

Valve Manifold Box
Valve Manifold Box
Valve Manifold Box
Valve Manifold Box
Valve Manifold Box

Dimensions (mm)

500 X 500
800 X 500
1200 X 500
1600 X 500
2000 X 500



Composite Manhole Covers

Composite manway covers have now been in use for over 15 years and are fast becoming the cover of choice. Non corrodible, easy to move and water tight, the Forecourt Solutions Composite Covers have been tested to AS3996-2006 and passed the class D load test making them one of the strongest covers on today's market. The covers have a clear inside access diameter of 900mm.

Product Number
MBXMAN-C



Underground Tank Manway Covers

Aluminium Manhole Covers

MBXMAN

The manway covers are wholly cast from Primary Aluminium. They comply with Australian AS 3996 - 1992 Class C Loading Standards. They have a clear inside access diameter of 920 mm.

1. Designed in consultation with and professionally engineered for the Petroleum Industry.
2. Support Ring, Lid and Tobies manufactured from Primary Aluminium to A.D.C. Standard CC601/TI to provide the cover with high strength, light weight and maximum resistance to corrosion.
3. Tobies flush mounted and sealed to avoid traffic rattle, minimise pedestrian hazard and prevent ingress/egress of water vapour.
4. Aesthetically pleasing surface finish with grip thread pattern for traffic and pedestrian safety.
5. Support Ring of design to facilitate cost effective installation in forecourt concrete.
6. Provision of installation Jack Lugs to allow the Support Ring to be correctly located and supported until the concrete has been poured and cured.
7. Enhanced lid seal effectiveness through use of six Lid retaining screws allowing optimum compression of special "D" seal and the incorporation of drainways to free water from the seal surround.
8. Tamper Free Security through use of recessed Lid retaining screws and offset keyhole for lid and toby removal.



Product No.	Description
MBXMAN	Plain Manway Cover
MBXMANT	Plain Manway Cover with Centre Toby
MBXLPG	LPG Manway Cover
MBXTOBL	Toby Lifter
MBX360T	360mm Diameter Toby only
MBX250T	250mm Diameter Toby only

Spill Box Seals

The manway covers are wholly cast from Primary Shipman King's Spill Box seals continue to evolve as the industry needs change. From our Flange Style Spill Box seal to the recent Convoluted Spill Box seal, all our seals allow for that extra pipe movement that may occur during the filling operation. Our standard 100mm seals are manufactured from nitrile rubber, but they can also be manufactured from viton rubber for that extra protection against some of the fuels on today's market.

Product Number SPBXT100
Description Flange Style with no holes to suit 4" riser pipes (3" Insert can be provided for 3" riser pipes)



Product Number SPBXT100
Description Flange Style with holes to suit 4" riser pipes (3" Insert can be provided for 3" riser pipes)



Product Number SPBXWB-C
Nitrile Rubber
SPBXWB-CV
Viton Rubber
Description Convoluted Style to suit 4" riser pipes
(3" Insert can be provided for 3" riser pipes)



Spill Box Drain Valve

The Spill Box Valve now comes in various heights for ease of operation. The Big Boy valve has been designed for extra strength and includes an aluminium foot plate.

Product Number

SPBXV

SPBXV-BB

Description

Standard Spill Box Valve

Big Boy Spill Box Valve

