

## customer/technical services

For any technical or installation queries please contact Vado on 01934 745163.

## guarantee

This product is guaranteed against manufacturing defects from the date of purchase until the expiry of the relevant guarantee period shown below.

### The guarantee is only valid if:-

1. The product has been installed, used and maintained in accordance with Vado's instructions and subjected to normal use only.
2. The defect is not due to use of an unsuitable or inadequate water or power supply.
3. The defect is not due to accident, misuse, neglect or repair other than by Vado or Vado authorised agents or damage caused by foreign objects or substances.
4. We have received from you the completed Guarantee Registration Form. Vado accepts no responsibility for any forms lost in the post and returns by registered means is therefore recommended.

Under this guarantee (which is non-transferable) Vado will, at its option, repair or replace free of charge any product (or replacement part) found to be defective. The guarantee does not extend to any consequential loss or damage. After repair or replacement the relevant guarantee period will be calculated from the original date of purchase.

### The relevant guarantee periods are:-

1. Twelve years on chrome finish products.
2. Three years on all other products with the exception of Stuart Turner Pumps which carry a 2 year Guarantee on Monsoon Range and 1 Year Guarantee on Showermate Range.

All claims under the guarantee must be submitted in writing to the person who supplied the product to you and must be received no later than the last day of the relevant guarantee period. All claims must be accompanied by proof of purchase (sales receipt or delivery note).

Vado operates a policy of continuous product development and therefore reserves the right to change the product, packaging and documentation specifications without notice.

This guarantee is in addition to and does not affect your statutory rights as a consumer.

### Vado

Wedmore Road, Cheddar, Somerset, England BS27 3EB  
tel 01934 744466. fax 01934 744345  
technical@vado-uk.com  
www.vado-uk.com

### GUARANTEE REGISTRATION

|                            |                |           |         |      |
|----------------------------|----------------|-----------|---------|------|
| NAME                       |                |           |         |      |
| ADDRESS                    |                |           |         |      |
|                            | POSTCODE       |           |         |      |
| RETAILER                   |                |           |         |      |
| ADDRESS                    |                |           |         |      |
|                            | POSTCODE       |           |         |      |
| PURCHASE DATE              | ARTICLE NUMBER | (SEE BOX) |         |      |
| PRODUCT DESCRIPTION        |                |           |         |      |
| WHO INSTALLED THE PRODUCT? | RETAILER       | PLUMBER   | BUILDER | SELF |
| FOR VADO USE               |                |           |         |      |



## installation & maintenance instructions

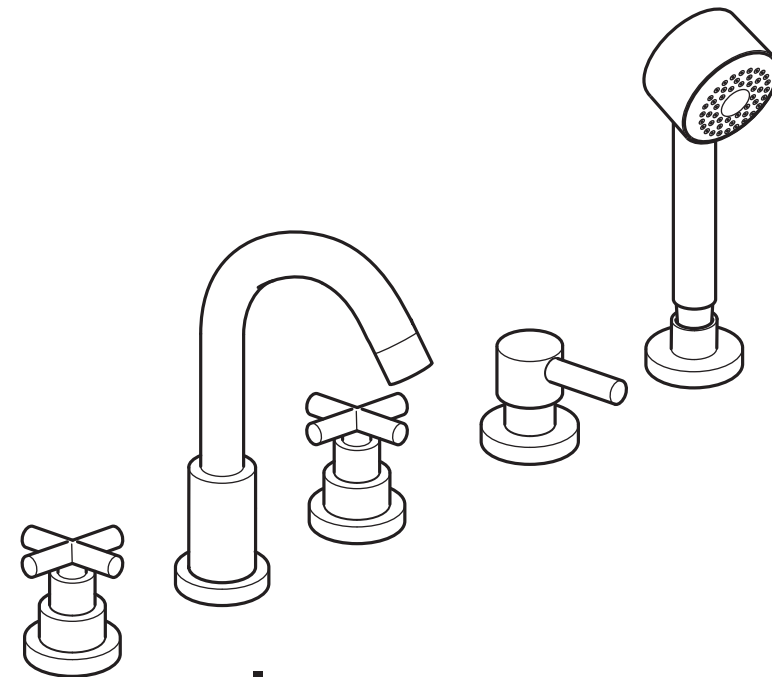

# elements

5 hole deck mounted concealed bath shower mixer  
5 hole deck mounted concealed bath shower mixer without kit

**please leave these instructions with the customer**

## important - please read

Please read these instructions carefully before starting installation and keep for future reference.

Remove all packaging and check the product for missing parts or damage before starting installation.

Any alterations made to this product and fittings may infringe water regulations and will invalidate the guarantee.

The installation must comply with all Local/National Water Supply Authority Regulations/Byelaws and Building and Plumbing (UK:BS6700) Regulations.

We strongly recommend that you use a qualified and registered plumber.

## general installation

These fittings are mixing devices and therefore water supplies must be reasonably balanced.

Where connections are made to the mains cold water supply, WRC approved single check valves must be fitted to both hot and cold inlets. This is a stated requirement of Water Supply (Water Fittings) Regulations 1999 Schedule 2, Section 6 G15.13.2

Before making any inlet pipe connections, all supply pipes MUST be thoroughly flushed to remove debris. Failure to do so could result in damage or low flow from the mixer unit. Water Supply (Water Fittings) Regulations 1999 Schedule 2 Section 4 G13.1

The fitting of isolating valves to the inlet feeds is advised for ease of maintenance.

Please take great care when installing this mixer not to damage its surface.

Please note if installing in an enclosed environment, access should be left for servicing and maintenance. No costs relating to inadequate access can be accepted.

## care of the taps

Our products are finished to the highest standard and due care needs to be taken to ensure their looks are retained.

We recommend cleaning all products with a soft damp cloth ONLY and advise strongly against the use of ALL cleaning products i.e. powders and liquids.

If the above instructions are not followed this will invalidate your guarantee in the event of a problem occurring.

## operation

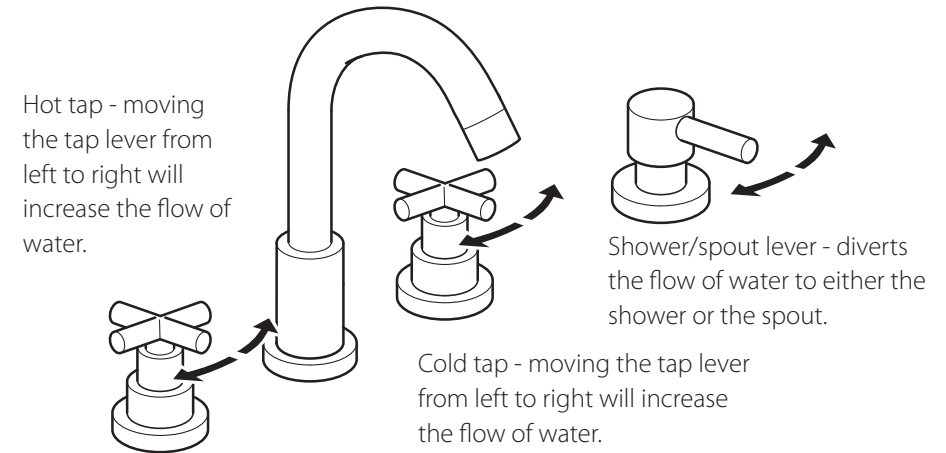

## maintenance

The mixer is supplied with an aerator fitted as standard. To improve the flow rate in low pressure conditions this aerator can be changed for the plastic flow straightener provided.

Carefully unscrew the mixer nozzle taking great care not to damage the plated finish.

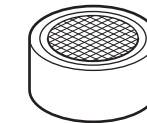

aerator (fitted)

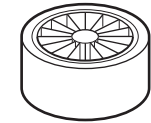

flow straightener

## installation - spout and shower

For Ele135/XK please ignore handset installation

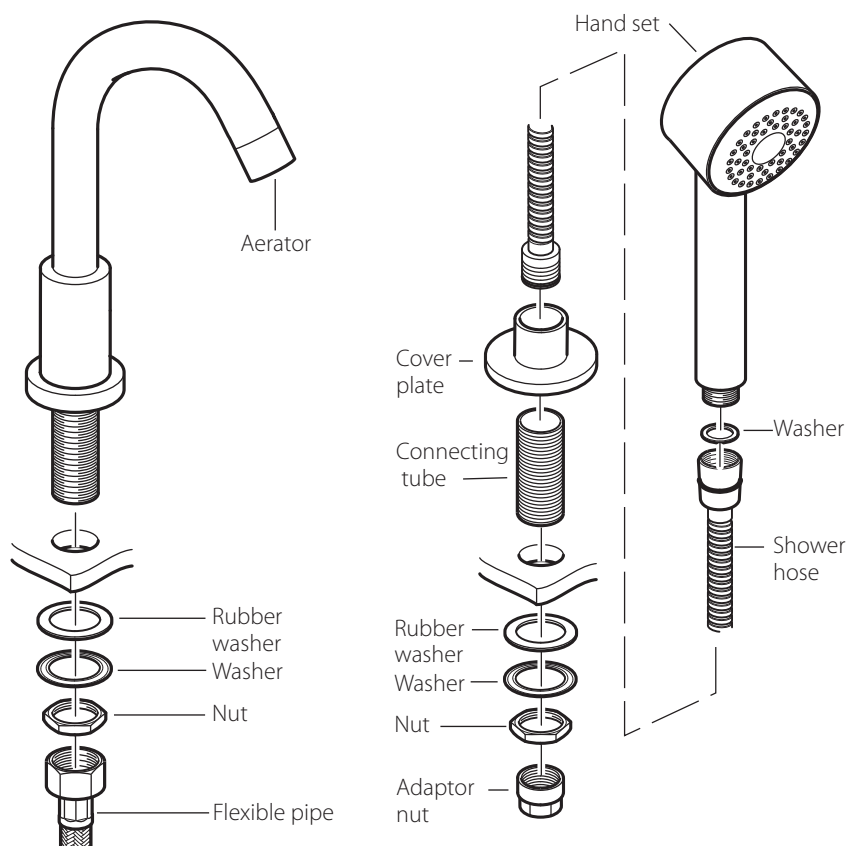

Position the spout in place, and from the underside slide on the rubber washer, metal washer and then the nut. Tighten the nut to clamp on the spout.

CAUTION: Do not over tighten the nuts.

Connect the spout to the valve using one of the flexible pipes.

Screw the connecting tube into the cover plate and position in the hole, from the underside slide on the rubber washer, metal washer and then the nut. Tighten the nut to clamp on the spout.

CAUTION: Do not over tighten the nuts.

Place the rubber washer into the cone end of the hose and screw to the handset, thread the other end of the shower hose down through the cover plate and screw on the adaptor nut.

Connect the adaptor nut to the outlet ports on the diverter valve.

## dimensions

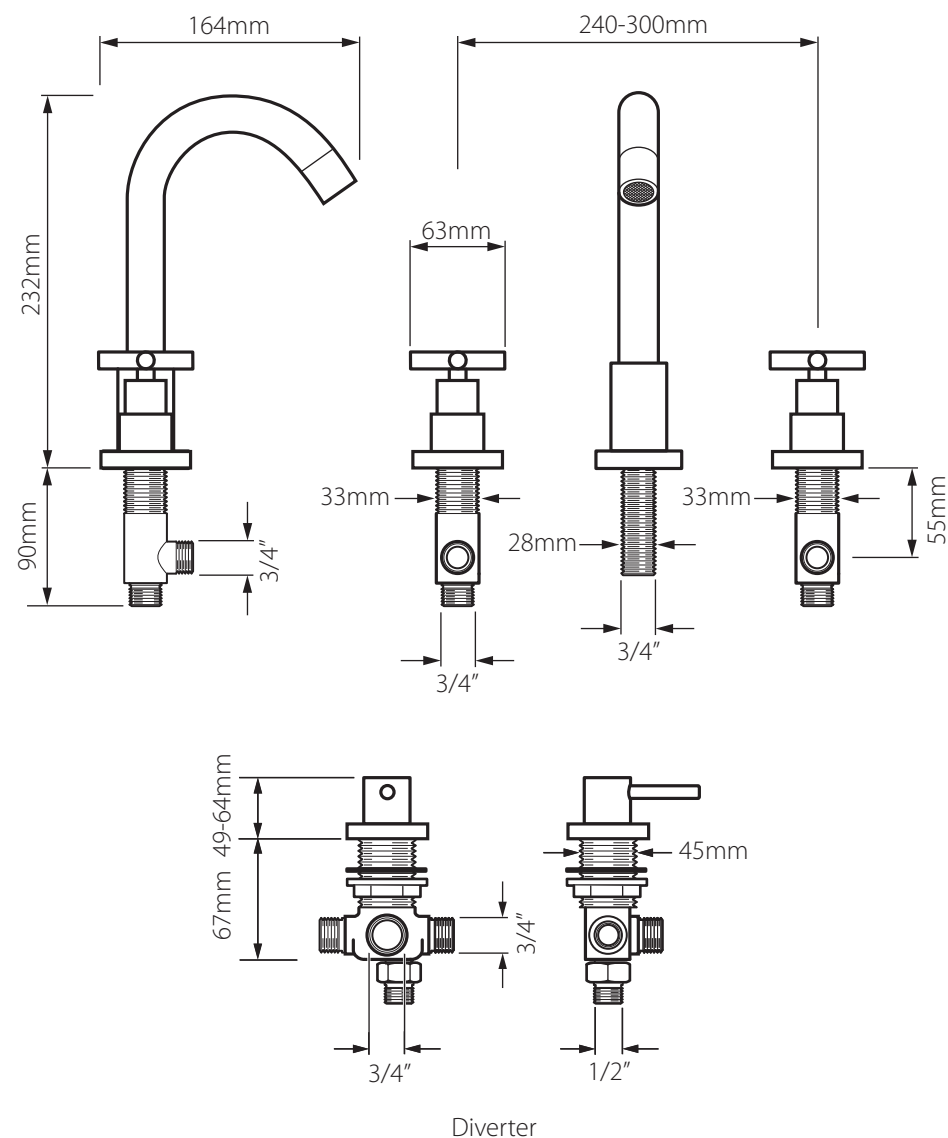

## Operating Specifications

Minimum operating pressure 0.7 bar

## installation - tap

Before installing your new tap, flush through the pipework to ensure removal of debris, turn off the water supply.

Screw a nut onto the valve body followed by metal washer then a rubber washer, push the valve up through the hole in the basin making sure the inlet hole is pointing in the right direction.

Slide on a rubber washer, metal washer and then a nut. Tighten the nut to clamp the valve to the basin.

The position of the valve can be adjusted by repositioning the backnut and then tightening the front.

Screw on the cover.

Carefully push the control handle onto the splines of the valve and screw in the base.

**CAUTION:** Do not over tighten the nuts as this might damage the basin.

Connect the water supply to the inlet pipes. The hot water should be connected to the left hand pipe.

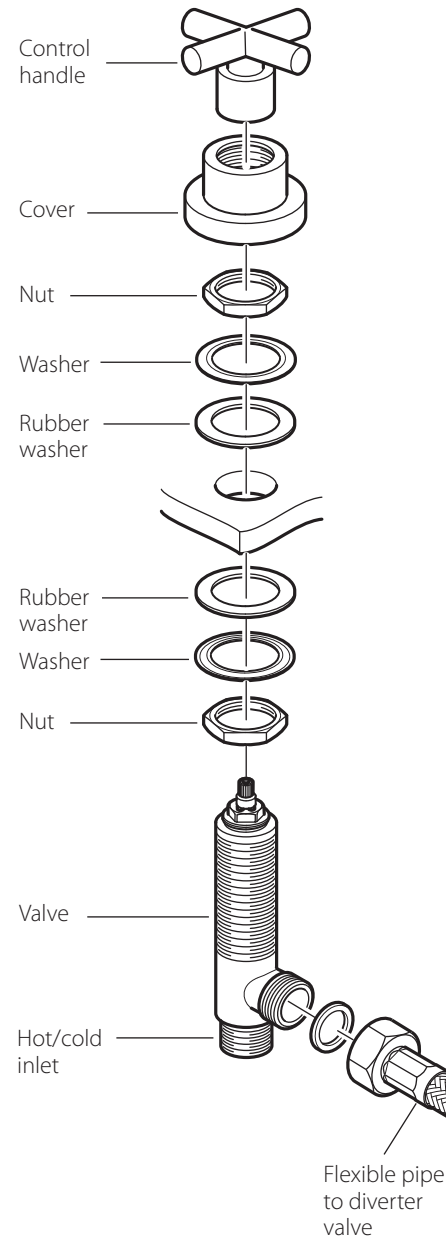

## installation - diverter valve

Screw the nut onto the valve body followed by a rubber washer, push the valve up through the hole in the unit.

Screw on the cover, carefully push the control handle onto the splines of the valve and secure using the hexagonal screw, plug in the rubber cover.

From the underside tighten the nut to secure the valve in place.

**CAUTION:** Do not over tighten the nuts as this might damage the unit.

Connect the valve to the tap, shower and spout using the flexible connectors.

