

Product Information

COLUMN Range

Looking to add an individual, stylish feature to your rooms? The **MYSON COLUMN** range has turned the humble radiator into a focal point and created a selection of new interior design possibilities for you.

The proportions, scale and detailing of the **MYSON COLUMN** combine to give a symmetry and elegance that feels just right. Each unit is manufactured using the very latest, unique laser welding technology to create a radiator range of the highest quality, with a paint finish that is second to none. There is a colour, size and column configuration to suit every situation. **COLUMN** radiators are ideal for a variety of domestic or commercial uses.



DÉCOR Range

The **MYSON DÉCOR** range has played a leading role in the world of interior design over the last decade. It treats radiators as decorative items as well as heating devices. With four distinctive flat tube styles to choose from you can find a model to enhance the look of any interior. We think you'll agree that the **MYSON DÉCOR** range offers some stunning alternatives to mainstream radiators.

The style, quality of construction and paint finish are of the highest order, so you can feel confident using **MYSON DÉCOR** in the most prestigious environments.



General Specifications

Approval and Certification



All MYSON COLUMN & DÉCOR radiators are manufactured and tested to EN 442.

All MYSON COLUMN & DÉCOR radiators carry a 10 year guarantee from date of installation against defects caused by faulty materials or manufacture.

Paint Finish

Every MYSON COLUMN & DÉCOR radiator undergoes a multi-stage pre-treatment process followed by an epoxy polyester primer coating. A stoved epoxy polyester powder coat in white (RAL 9016) is applied to all front and rear surfaces allowing the MYSON COLUMN & DÉCOR to be fitted without further painting. Other colours are available, please refer to page 14.

Manufacture

MYSON COLUMN radiators are manufactured using a unique laser welding process that virtually eliminates the visible welding points associated with the traditional methods of manufacturing this type of radiator. The clean finish significantly enhances the aesthetic qualities of the radiator.

Fixings

For the correct installation of radiators it is essential that the fixing of the radiator is carried out in such a way that it is suitable for intended use AND predictable misuse. A number of elements need to be taken into consideration including the fixing method used to secure the radiator to the wall, the type and condition of the wall itself, and any additional potential forces or weights that may happen to be applied to the radiator, prior to finalising installation.

Application

MYSON COLUMN & DÉCOR radiators are for use on two pipe, pumped, indirect, domestic and commercial central heating installations, with a maximum working temperature of 120°C for COLUMN and 100°C for DÉCOR. The system should be designed in accordance with BS 5449 or BS 6880 as appropriate, with particular care taken to avoid air entry or water discharge.

We do not recommend the use of single feed indirect cylinders, as the possibility of aeration due to water interchange may lead to corrosion.

The installation work must be carried out in accordance with recognised good practice, and precautions taken to avoid contamination which could lead to corrosion. If a corrosion inhibitor or other water treatment is to be used, the Manufacturer's Instructions must be strictly followed.

All systems must be designed with suitable pipe sizing (15mm or 22mm minimum depending on the length of run) and with a pump or adequate pump head. Failure to do this may lead to trapped air and cold spots because of insufficient pressure and water flow will not drive the air from the radiator. The taller and more tubes a radiator has, the more likely this is to happen.

The recommendations of BS 7593, Code of Practice for treatment of water in domestic central heating systems, should be observed.

Safety Precautions

Radiators are hot when in use, and as such, present a risk of burns to users on prolonged contact. The temperature of a radiator is dependent on the temperature of the system water, as set by the system installer or user. Installers and users should ensure that those who may come into close proximity to hot radiators are aware of the risk of burns. Installers and users should take all necessary steps to minimise the risks of burns. If the risk is significant, consideration should be given to installing low surface temperature radiators, or to placing guards in front of the radiators.

Tube Details (COLUMN)

Precision, D-profile steel tube is used for all outside surfaces which ensures high outputs and soft, rounded edges for maximum safety.

Tube Dimensions (DÉCOR)

Headers

Triangular 51mm x 42mm x 42mm header: thickness 1.5mm

Heating tubes

Flat 70mm x 11mm: thickness 1.25mm

Heat Output

The heat outputs for all COLUMN radiators can be found on pages 10 and 11 and the heat outputs for MYSON DÉCOR radiators can be found on pages 12 and 13. The tabulated figures are quoted in accordance with EN 442 for a mean water to air temperature of 50°C. When the difference is not 50°C, the output should be multiplied by the appropriate factor from within the table below:

Centigrade	Factor	Fahrenheit
40°C	0.75	72°F
45°C	0.87	81°F
50°C	1.00	90°F
55°C	1.13	99°F
60°C	1.27	108°F
65°C	1.41	117°F
70°C	1.55	126°F

Fixing Brackets (supplied with every radiator) - Wall Brackets

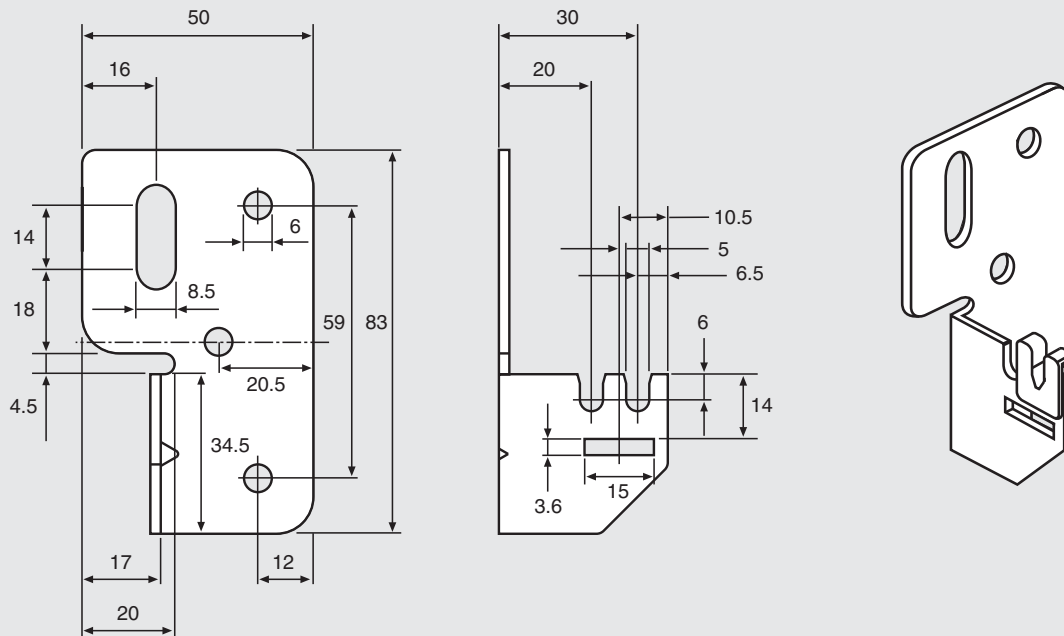

Radiator Brackets

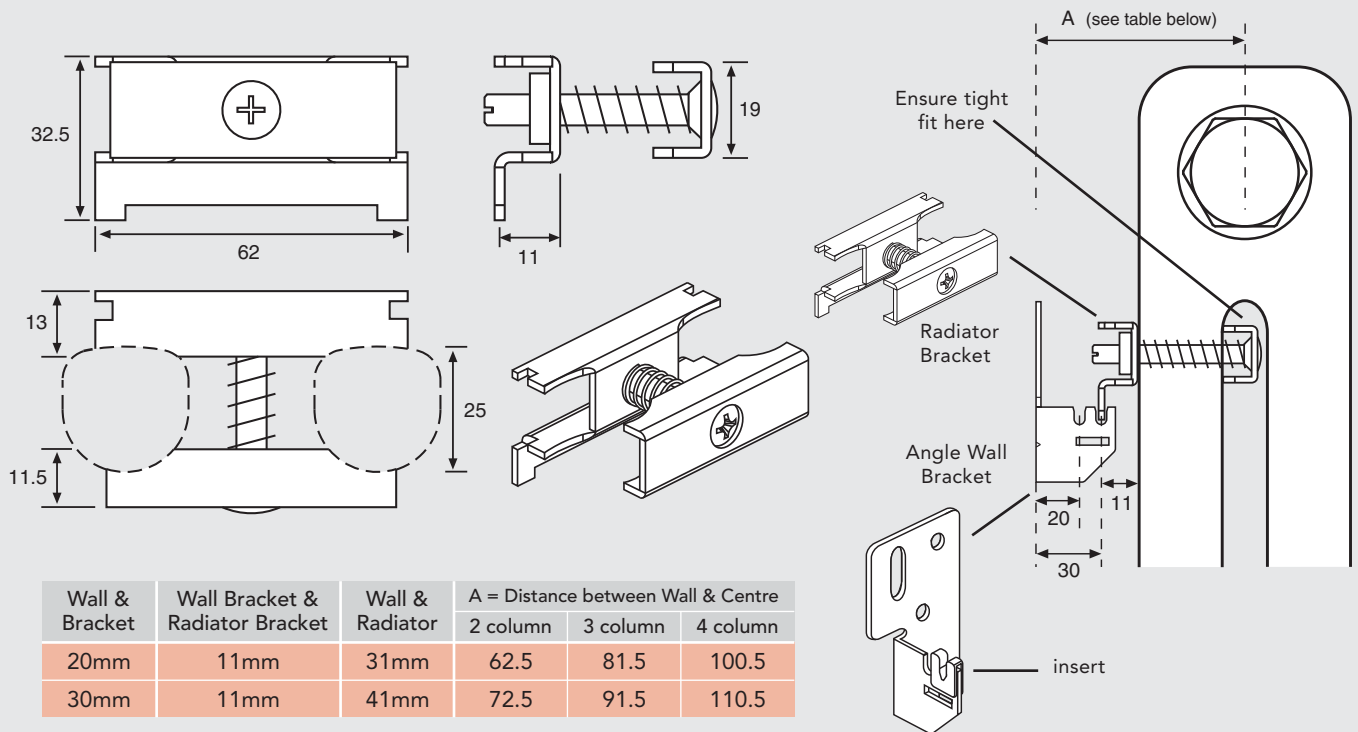

Connections

All **MYSON COLUMN** radiators are fitted with 4 x 1/2 inch BSP connections.

Radiators include plug and vent.

Radiators are manufactured with an internal baffle. The tapping with the baffle is identified with a red plastic cap, all others being blue. It is

important that the water inlet is connected to the tapping identified in red.

N.B. The radiator is suitable for the use of BBOE (Bottom Bottom Opposite End), TBSE (Top Bottom Same End) and TBOE (Top Bottom Opposite End) connections. TTOE (Top Top Opposite End) connections cannot be used.

Fixing Brackets - Clamped Floor Bracket FK

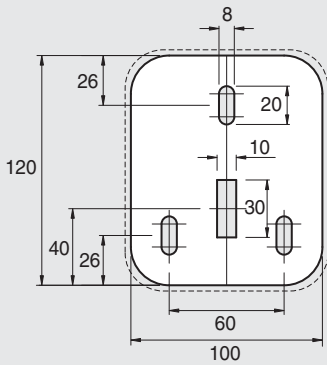

Dimensions of base-plate for Clamped Floor Bracket FK
(----- = base-plate cover)

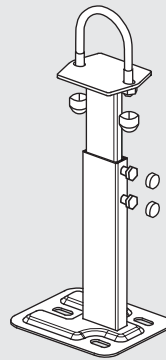
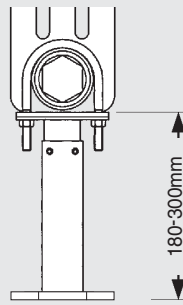

For use with 2-6 column radiators

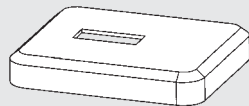

Two-part cover for base-plate in white plastic 106 x 128mm

Complete system for free-standing radiators, from 2-6 column up to 1000mm height. Painted to RAL 9016.

Comprises;

- 3mm thick base-plate fixing for either finished or unfinished floor

Clamped Floor Bracket FK	Order Code
For 2-6 Column Rads.	FK1021
Base-Plate Cover	COVERFK

Floor Bracket SK

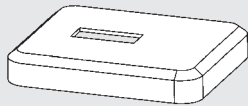

Two-part cover for base-plate in white plastic 110 x 135mm

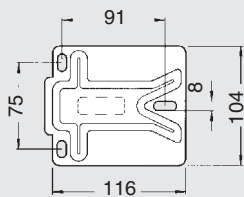

Dimensions of base-plate for Floor Bracket SK

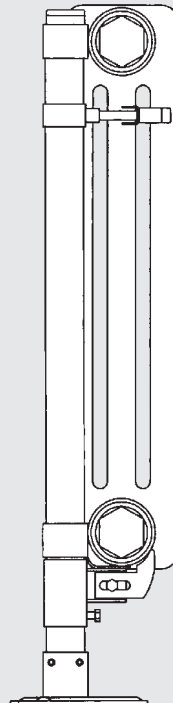
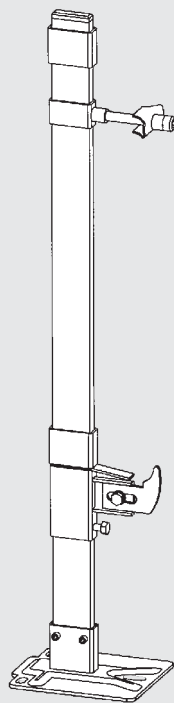

Complete system for free-standing radiators, from 2-6 column up to 1000mm height. Painted to RAL 9016.

Comprises;

- 3mm thick base-plate for fixing to either finished or unfinished floor
- upright support 35 x 10 x 1.5mm, fixing set with adjustable bracket, security fixing, anti-vibration insert
- adjustable bottom support with spacer and security fixing, anti-vibration insert, white plastic end stop for top of upright.

Height of Upright	Height of Radiator	Order Code
460	300	SK20046
610	450	SK20061
760	600	SK20076
910	750	SK20091
Base-Plate Cover		COVERSK

Operating Pressures

Every MYSON COLUMN radiator is tested to a pressure of 13 bar (188.5 psi) and is suitable for a working pressure of up to 10 bar (145 psi).

2 COLUMN

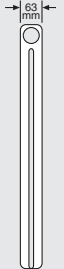

Length (mm - in)	Sections	Height 450mm (18in)			Height 600mm (24in)				
		Output (watts)	Output (Btu/h)	Order Code	Length (mm - in)	Sections	Output (watts)	Output (Btu/h)	Order Code
600 - 24	12	435	1485	12 SEC 2045	600 - 24	12	564	1925	12 SEC 2060
800 - 32	16	580	1980	16 SEC 2045	800 - 32	16	752	2567	16 SEC 2060
1000 - 40	20	725	2474	20 SEC 2045	1000 - 40	20	940	3209	20 SEC 2060
1200 - 47	24	870	2969	24 SEC 2045	1200 - 47	24	1128	3850	24 SEC 2060
1400 - 55	28	1015	3464	28 SEC 2045	1400 - 55	28	1317	4492	28 SEC 2060
1800 - 72	36	1305	4454	36 SEC 2045					

3 COLUMN

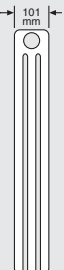

Length (mm - in)	Sections	Height 300mm (12in)			Height 450mm (18in)				
		Output (watts)	Output (Btu/h)	Order Code	Length (mm - in)	Sections	Output (watts)	Output (Btu/h)	Order Code
800 - 32	16	566	1933	16 SEC 3030	600 - 24	12	606	2068	12 SEC 3045
1000 - 40	20	708	2416	20 SEC 3030	800 - 32	16	808	2757	16 SEC 3045
1400 - 55	28	991	3382	28 SEC 3030	1000 - 40	20	1010	3446	20 SEC 3045
1800 - 71	36	1274	4348	36 SEC 3030	1200 - 47	24	1212	4135	24 SEC 3045
					1400 - 55	28	1414	4825	28 SEC 3045
					1800 - 72	36	1818	6203	36 SEC 3045

4 COLUMN

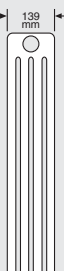

Length (mm - in)	Sections	Height 600mm (24in)			Height 750mm (30in)				
		Output (watts)	Output (Btu/h)	Order Code	Length (mm - in)	Sections	Output (watts)	Output (Btu/h)	Order Code
600 - 24	12	997	3402	12 SEC 4060	600 - 24	12	1214	4144	12 SEC 4075
800 - 32	16	1330	4537	16 SEC 4060	800 - 32	16	1619	5525	16 SEC 4075
1000 - 40	20	1662	5671	20 SEC 4060	1000 - 40	20	2024	6906	20 SEC 4075
1200 - 47	24	1994	6805	24 SEC 4060	1200 - 47	24	2429	8287	24 SEC 4075
1400 - 55	28	2327	7939	28 SEC 4060	1400 - 55	28	2834	9668	28 SEC 4075

Architecture Range

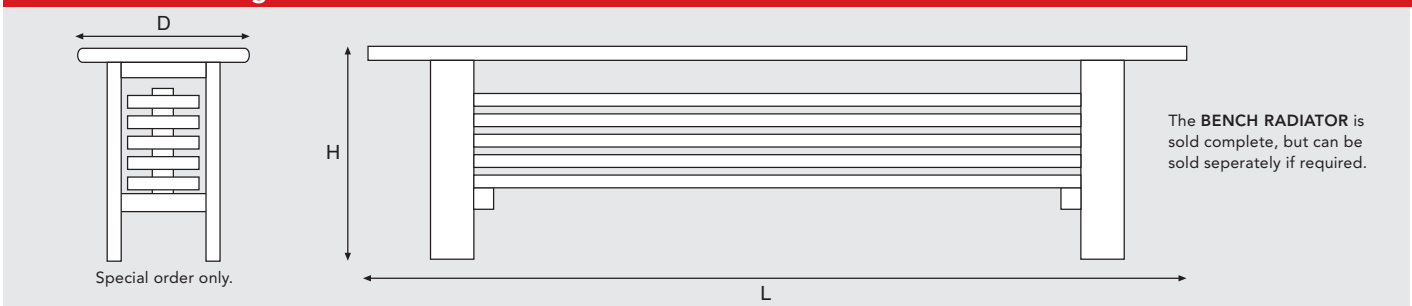

Accessories

Lambswool Cleaning Brush

Product Code: COLUMNBRUSH

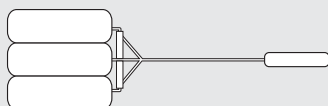

Towel Rail

Clip-on rail to fit all radiators up to 1m long (20 sections)

Product Code: 12SECRAIL
16SECRAIL
20SECRAIL

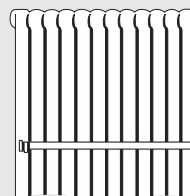

Decorative Foot

Product Code: COLDECFOOT

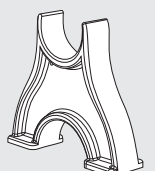

Height 2000mm (79in)				
Length (mm - in)	Sections	Output (watts)	Output (Btu/h)	Order Code
300 - 12	6	881	3006	6 SEC 2200
400 - 16	8	1175	4008	8 SEC 2200
500 - 20	10	1468	5010	10 SEC 2200
600 - 24	12	1762	6012	12 SEC 2200
750 - 30	15	2202	7515	15 SEC 2200

Height 600mm (24in)					Height 750mm (30in)				
Length (mm - in)	Sections	Output (watts)	Output (Btu/h)	Order Code	Length (mm - in)	Sections	Output (watts)	Output (Btu/h)	Order Code
600 - 24	12	781	2665	12 SEC 3060	600 - 24	12	935	3251	12 SEC 3075
800 - 32	16	1042	3554	16 SEC 3060	800 - 32	16	1270	4335	16 SEC 3075
1000 - 40	20	1302	4442	20 SEC 3060	1000 - 40	20	1588	5418	20 SEC 3075
1200 - 47	24	1562	5331	24 SEC 3060	1200 - 47	24	1906	6502	24 SEC 3075
1400 - 55	28	1823	6219	28 SEC 3060	1400 - 55	28	2223	7586	28 SEC 3075

Bench Range					
Length inc. seat (mm - in)	Height inc. seat (mm - in)	Depth inc. seat (mm - in)	Output (watts)	Output (Btu/h)	Order Code
1850 - 73	472 - 19	365 - 14	1489	5080	23 SEC 056150
1850 - 73	522 - 21	365 - 14	1738	5930	23 SEC 066150
2150 - 85	472 - 19	365 - 14	1816	6196	23 SEC 056180
2150 - 85	522 - 21	365 - 14	2119	7230	23 SEC 066180
2350 - 93	472 - 19	365 - 14	2053	7005	23 SEC 056200
2350 - 93	522 - 21	365 - 14	2396	8175	23 SEC 066200

Includes TRV and Lockshield Kit.

Fixing Brackets

Product Code: FK1021
Product Code: COVERFK

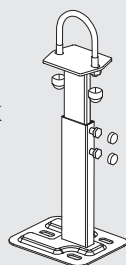

Floor Brackets

Product Code: SK20046
Product Code: SK20061
Product Code: SK20076
Product Code: SK20091
Product Code: COVERSK



For choice of colours, please refer to page 14.

Colour Board

COLUMN.



White/Ref. 1S
Ral 9016



Cream/
Ral 9001

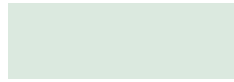

Aegean Green/
T20



Pergamon/
T14



Light Grey/
Ral 7035



Bahama Beige/
T10



Manhattan/
T11



Yellow/
Ral 1023



Mustard/
Ral 1003



Calypso/
T27



Dove/
Ral 5014



Violet/
Ral 4008



Blue/
Ral 5002



Garden Green/
Ral 6010



Moss Green/
Ral 6005



Ruby Red/
Ral 3003



Wine/
Ral 4004



Brown/
Ral 8007



Chocolate/
Ral 8017



Black/
Ral 9004

DÉCOR.



White/Ref. 1S
Ral 9016



Pergamon/
Ref. 64



Jasmin/
Ref. 63



Natura/
Ref. 73



Bahama Beige/
Ref. 61



Metallic Silver/
Ref. 27

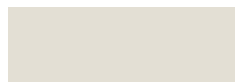

Edelweiss/
Ref. 59

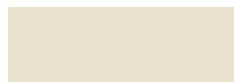

Camelia/
Ref. 53



Manhattan/
Ref. 31



Pastel Rose/
Ref. 54



Pastel Blue/
Ref. 56



Cool Mint/
Ref. 70



Keywest/
Ref. 80

IMPORTANT

We can match any colour - please supply RAL reference.

Due to print restrictions, exact colour match of swatches is not possible. However, every effort has been made to ensure as much accuracy as possible.