

Contour 21 what works and why

An informative guide to commercial bathroom solutions for all sectors

Armitage Shanks

Armitage
Rugeley
Staffordshire
WS15 4BT
England

Tel: 01543 490253
Fax: 01543 491677

www.armitage-shanks.co.uk

Technical helpline: 0870 122 8822

*Armitage
Shanks*



*Armitage
Shanks*

Contour 21

A solution for every sector

Contour 21 sanitary ware and fittings are designed to meet the rigorous demands of today's commercial installations. Tailored to the individual needs of each construction sector, Contour 21 blends striking aesthetics with enhanced durability and combines improved water efficiency with regulatory compliance.

Hospitals

Schools

Offices

Armitage Shanks

Leisure

Public Buildings

Stadia

Hotels

Contour 21

Every bathroom, every building, everywhere

Each type of building places a unique demand on the products and facilities within it. Contour 21 meets the performance and regulatory needs of every different sector, these are just a few of them.

Schools

Research has proven the common sense belief that clean, safe and functioning school toilets promote improved behaviour. Creating toilets pupils value, and can use when required, has a positive influence on their health, willingness to learn and attendance.

Armitage Shanks, the primary sponsor of the "Bog Standard" campaign for school toilet improvement, has been a key supplier to schools since 1910. School specific Contour 21 products have been designed in line with recent government guidelines to cope with heavy duty use and minimise water wastage.



Hospitals

The specification of sanitary ware and fittings for healthcare use can be a critical decision. For over 50 years Armitage Shanks has specialised in developing products that meet the complex functional requirements of hospital environments and the demands of government legislation.

Healthcare specific Contour 21 WC's and basins share modern ultra-hygienic designs which are fully compliant with the Department of Health's Health Technical Memorandum 64, while Markwik 21 mixers have been developed in line with the requirements of HFN30, HTM04 and HTM64.

Offices

Forward thinking businesses, concerned with helping their staff perform at optimum levels, realise their washrooms make a significant statement about the company's, and management's, attitude towards the people who work for it. While different organisations require different approaches, the fundamental specification factors are common; fitness for purpose, water economy, return on investment, equal access for all, easy cleaning and the effective use of space.

Contour 21's extensive product collection features hard-wearing water efficient products suitable for the smallest offices and the largest corporate headquarters.

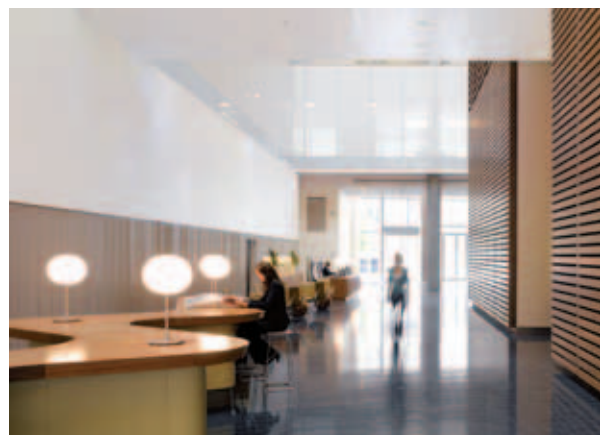



Leisure

The scope of buildings designed to cater for the growth in leisure activities is vast; from the small town museum, to the regional music arena, from the local golf course's clubhouse to the newest shopping centre or mega mall. Whatever size the building, the necessity to design durable, aesthetically pleasing, easy to maintain washrooms is just as important.

Water management is particularly significant in entertainment or shopping facilities and Contour 21's water efficient products can help reduce water wastage and utility bills.

Part M

The Disability Discrimination Act 2004 requires that commercial and public buildings are suitable for use by disabled people. The Act defines disability as long term physical or mental disabilities, and short term conditions, such as pregnancy. The washroom requirements necessary for compliance with this Act are described in Part M of the Building Regulations.

Armitage Shanks has developed Contour 21 Part M products in consultation with national disabled groups. These products meet the requirements of Part M and are suitable for an extensive range of applications.



Cardiff Millennium Stadium

Stadia

Over 1.3 million people visit Cardiff's Millennium Stadium annually. The UK's first fully retractable roof encloses almost 75,000 spectators for each major rugby or football game. Providing washroom facilities for the fans is the foundation of each successful event. While every venue may not share the prestige of the Millennium Stadium, functional, attractive and cost effective washroom design is just as important for local facilities.

Contour 21 is designed to cope with the demands of constant use in such heavy duty applications while minimising water wastage.



Hotels

Today's guest demands a lot from their room's en-suite; they expect to be impressed, they hope to be intrigued and they want to have nothing like it at home. For the hotelier however, there are concerns beyond simple aesthetics. They must balance style with ease of cleaning, performance with durability and ergonomics with water saving, particularly in public washrooms.

Achieving this may sometimes mean compromise, but with Contour 21 that is never necessary. Water efficiency, reliable performance, regulatory compliance and low maintenance are designed into every timeless Contour 21 piece.

Contour 21

Designed for the future

Commercial washrooms are subject to more stringent legislation, more inconsiderate use, harsher cleaning regimes and a tougher cost/benefit analysis than their domestic counterparts. Contour 21 has been designed specifically to meet these challenges.

Water Efficiency

Most commercial buildings, according to the Environment Agency, can reduce water consumption by around 50%. The Building Research Establishment's Environmental Assessment Method (BREEAM), sets the standard for best practice in sustainable design and is a useful measure of a building's level of achievement. When combined with the DEFRA backed Water Technology List, a collection of products that will make a positive impact on water saving, it will help to optimise the water efficiency of any project. Water saving is fundamental to the Contour 21 collection:

- Contour 21 dual flush WC's can flush on as little as 4.5/3 litres of water, a saving of up to 45%.
- Sensorflow 21's electronic washroom water management solution ensures water is only used when required.
- Contour 21 mixers are supplied with regulators to reduce their flow down to 5lt/pm at 3 bar.
- Contour 21 mixers include CLICK technology with "half" and "full" flow rate stops.
- Contour 21 non-concussive taps automatically stop water flow after a preset time, potentially saving 15%.

Hygiene

Cleanliness and hygiene are the primary concern of public washroom users, many will even employ personal rituals aimed at avoiding physical contact with surfaces. They will use all their senses to judge hygiene; aroma, lighting, texture and colour all play a part. A washroom's physical layout and size can also be a factor as the last available WC or urinal "that no one else wants" is often perceived as below standard, or unclean. Contour 21 products can help to optimise the hygiene performance of a washroom:

- Contour 21 sanitary ware's smooth external contours eradicate dirt traps.
- Contour 21 sanitary ware's internal design minimises cavities that can harbour bacteria.
- Contour 21 and Sanura 21 hygenIQ urinal's anti-splash fin reduces urine splash back by up to 90%.
- Contour 21 WC's rimless pans eliminate a traditional bacteria haven.
- Contour 21 wall hung WC pans encourage faster more effective floor cleaning.
- Contour 21 back outlet basins are designed for "in wall" traps, making cleaning easier.
- Markwik 21 mixers can be easily disinfected, stopping the growth of bacteria such as legionella.



Durability

Commercial washrooms inevitably endure higher levels of use and receive rougher treatment than their domestic counterparts. Their durability will therefore be vital in delivering a cost effective design and specifying hard wearing, low maintenance products will help reduce full life costs. Rigorous daily cleaning regimes can degrade the finishes of products not designed for commercial environments. Commercial grade durability is built-in to the Contour 21 collection:

- Contour 21 sanitary ware is finished in high performance glaze for long term performance and colour retention.
- Contour 21 mixers use special seals to prevent commercial cleaning products entering the mixer body and damaging the cartridge.
- Contour 21 mixers and fittings are guaranteed for 5 years.
- Contour 21's anti-slip coating for baths and showers is guaranteed for 10 years.
- Contour 21 ceramic products have a lifetime guarantee.



Maintenance

Minimising the down-time of a commercial bathroom or washroom is critical to its success. An "out of order" sign will at best annoy the user, and at worst cost the owner money. Choosing sanitary ware that is designed for low maintenance, and also ease of maintenance, will help to keep a facility fully operational. Sometimes even the toughest products fail and the on-going availability of spare parts must also be considered when preparing a scheme. Contour 21 products are quick and easy to maintain and deliver long term performance:

- Contour 21 products are manufactured and guaranteed by the market leader in commercial sanitary ware.
- Contour 21 products are supported by a comprehensive, and long term, replacement parts service.
- Contour 21 sanitary ware's clean, organic design makes cleaning faster and more effective.
- Markwik 21 panel mounted mixers can be serviced from the front, without removing wall panels.

Sustainability

Sustainability is now seen as an area of competitive advantage in the commercial arena and choosing long lasting and environmentally responsible products is increasingly important. Armitage Shanks is committed to minimising the impact of its manufacturing processes on the environment. Over the last decade we have invested in cleaner, more energy efficient plant and introduced many sustainable practices:

- In 1998 less than 10% of the clay effluent we produced during vitreous china casting was re-used. Today over 80% of it is recycled for use in the production of floor tiles and bricks.
- In 2006 a new glaze Ultra Filtration System was installed at our Rugeley facility. As a result the glaze waste we send to landfill has reduced by 900 tonnes/year and discharge fallen by 12,000m³/year.
- In 2000 producing 1kg of sanitary product created 1.36kg of CO₂. By improving the energy efficiency of our manufacturing processes we have reduced that to 1.15kg of CO₂/kg of product.

Contour 21

Multiple choices for multiple applications

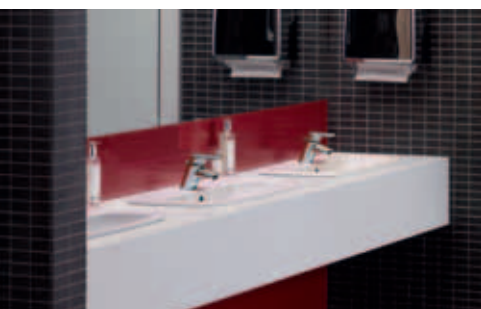

For almost every sector of the commercial washroom market there is a Contour 21 product that has been designed to meet its needs. Because every piece has been developed with the performance, durability and regulatory demands of the

broader commercial market in mind, many Contour 21 products can be used across several different market sectors. This flexibility allows the specifier to mix and match styles to create unique bathrooms over a broad spectrum of applications.

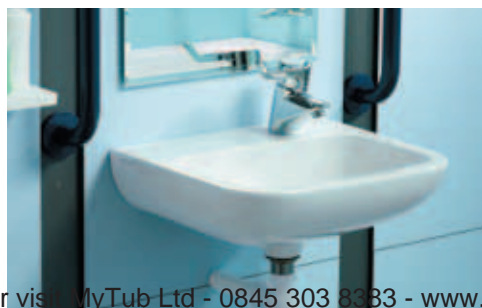
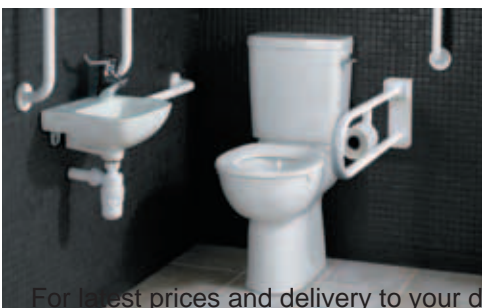
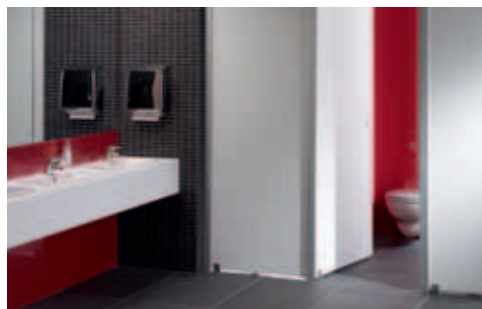
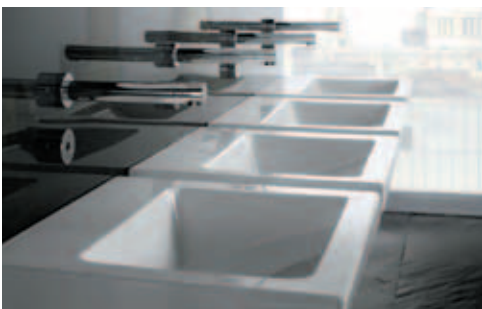

Contour 21

New products, new possibilities, new options

Established Armitage Shanks' products and exceptional new designs have joined the Contour 21 family, creating an extended sanitary ware solution for every commercial sector.



The additions to the Contour 21 family mean it can now serve an even wider range of sectors. While sharing the same durability and functionality, these new products have a "softer" commercial look suitable for installations where aesthetics are as important as performance.



Contemporary styling defines the new members of the Contour 21 range. Redesigned Profile, Planet and Orbit basins, and a new Contour 21 under-mount basin, give a designer feel to offices and high-end leisure facilities.

The elegant new Portman 21 pedestal basin, when combined with the new close-coupled Contour 21 WC, offers the perfect product solution where domestic products are required in a commercial application. Even the humble urinal has been reimagined and improved, thanks to the anti-splash fin of the hygenIQ Contour 21 urinal.

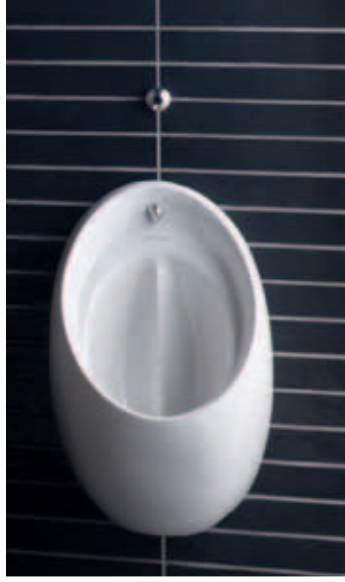



At the heart of every additional product is Contour 21's dedication to meeting the needs of the specifier. Despite looks that make these "designer commercial" products at home in a 4 Star hotel en-suite and executive washrooms, each one has been specially chosen for their ruggedness and fitness for purpose. From the smallest bathroom to the largest public facility, the extended Contour 21 collection has a choice of designs to satisfy the most demanding client.



Contour 21

Form and function perfectly combined

With durability and performance as its foundation, Contour 21's timeless and elegant aesthetics lift it beyond the constraints of normal commercial products. The "where, what and why" of the collections' key pieces are highlighted in the following pages.





Contour 21 Washbasins



Contour 21
37cm handrinse basin with right hand
taphole (S247401) *Above*
37cm handrinse basin with left hand
taphole (S247301) *Left*

- Right or left hand tap hole option
- No overflow or chain hole
- Part M compliant

See Contour 21 Price Guide for complete range of products and codes



Contour 21
37cm hand rinse basin (S212201)

- One centre tap hole
- No overflow or chain hole

See Contour 21 Price Guide for complete range of products and codes



Contour 21
60cm basin (S215501)

- Back outlet
- No tap holes, overflow or chain hole
- Concealed trap (not included)
- Suitable for use with ducts or panel systems
- Meets HTM64 requirements for clinical basins
- 50cm version also available

See Contour 21 Price Guide for complete range of products and codes



Contour 21
60cm accessible basin (S216801)

- One centre tap hole
- Improved design provides easier access for wheelchair users
- Side bars allow user to pull wheelchair up to basin
- Broad rim provides elbow support
- 55cm version also available

See Contour 21 Price Guide for complete range of products and codes



Portman 21
40cm basin (S231401)

- Right, left or one central tap hole option
- Two tap hole option or no tap hole option
- With or without overflow or chain hole
- Compact modern design for general washroom use
- Basin with no overflow meets HTM64 requirements for non clinical use

See Contour 21 Price Guide for complete range of products and codes



Portman 21
50cm basin (S225401)

- Right, left or one central tap hole option
- Two tap hole option or no tap hole option
- With or without overflow or chain hole
- Midsize design for general washroom use
- Basin with no overflow meets HTM64 requirements for non clinical use

See Contour 21 Price Guide for complete range of products and codes



Portman 21
60cm basin (S225601)

- Right, left or one central tap hole option
- Two tap hole option or no tap hole option
- With or without overflow or chain hole
- Contemporary design for general washroom use
- Basin with no overflow meets HTM64 requirements for non clinical use

See Contour 21 Price Guide for complete range of products and codes



Portman 21

55cm basin with semi-pedestal (S247801)

50cm basin with semi-pedestal (S248201) *Not shown*

- New from Armitage Shanks
- One, two or three tap hole option
- With overflow
- With or without chain hole
- Wall hung semi-pedestal
- Ideal for applications requiring a domestic look

See Contour 21 Price Guide for complete range of products and codes



Portman 21

50cm basin with full pedestal (S248201)

- New from Armitage Shanks
- One, two or three tap hole option
- With overflow
- With or without chain hole
- Full height pedestal
- Ideal for applications requiring a domestic look

See Contour 21 Price Guide for complete range of products and codes



Portman 21

55cm basin with full pedestal (S247801)

- New from Armitage Shanks
- One, two or three tap hole option
- With overflow
- With or without chain hole
- Full height pedestal
- Ideal for applications requiring a domestic look

See Contour 21 Price Guide for complete range of products and codes



Profile 21
50cm semi-countertop basin (S249401)

- New to Armitage Shanks
- One central tap hole or two tap hole option
- With overflow
- No chain hole
- Stylish rectangular design will suit school, hotel or office projects

See Contour 21 Price Guide for complete range of products and codes



Planet 21
50cm countertop basin (S248401)

- New from Armitage Shanks
- One central tap hole or two tap hole option
- With overflow
- No chain hole
- Stylish rectangular design will suit school, hotel or office project

See Contour 21 Price Guide for complete range of products and codes



Orbit 21
55cm countertop basin (S248601)

- New from Armitage Shanks
- One, two or three tap hole option
- With overflow
- No chain hole
- Oval design saves counter space when used in rows

See Contour 21 Price Guide for complete range of products and codes



Contour 21
50cm under countertop basin (S249601)

- New from Armitage Shanks
- Use with countertop or wall mounted taps, mixers and spouts
- With overflow
- No chain hole
- Simple contemporary design mounts under the counter

See Contour 21 Price Guide for complete range of products and codes



Airside
80cm washroom basin (S242801)

- One tap hole or no tap hole option
- No overflow or chain hole
- Incorporates shelf for personal belongings and washing kit

See Contour 21 Price Guide for complete range of products and codes



Leadenhall
55cm washroom basin (S205801)

- No tap holes
- No overflow or chain hole
- Back outlet suitable for concealed trap
- Striking tapered profile, starkly upmarket design

See Contour 21 Price Guide for complete range of products and codes



Cherwell
42cm under countertop basin (S257001)

- Use with countertop or wall mounted taps, mixers and spouts
- No chain hole
- Simple and pure large hemispherical bowl
- Glazed or unglazed options

See Contour 21 Price Guide for complete range of products and codes



Marlow
56cm under countertop basin (S256001)

- Use with countertop or wall mounted taps, mixers and spouts
- No chain hole
- Graceful elliptical bowl for any modern washroom
- 48cm version also available

See Contour 21 Price Guide for complete range of products and codes

Contour 21 WC's



Contour 21

75cm projection back-to-wall WC (S305301)

70cm projection back-to-wall WC (S305501) *Not shown*

- Rimless pan
- 46cm raised height for easier wheelchair transfer
- Compliant with Part M requirements
- Available with 4.5 single flush or 4.5/3 dual flush

See Contour 21 Price Guide for complete range of products and codes



Contour 21
Standard height rimless back-to-wall WC (S305601)

- Rimless pan
- Standard 41cm height for general use
- Standard projection
- Available with 4.5 single flush or 4.5/3 dual flush

See Contour 21 Price Guide for complete range of products and codes



Contour 21
46cm raised height rimless back-to-wall WC (S305701)

- Rimless pan
- 46cm raised height for easier wheelchair transfer
- Standard projection
- Compliant with Part M and HTM64 requirements
- Available with 4.5 single flush or 4.5/3 dual flush

See Contour 21 Price Guide for complete range of products and codes



Contour 21
46cm raised height closed coupled WC (S305401)

- Rimless pan
- 46cm raised height for easier wheelchair transfer
- 75cm extended projection
- Compliant with Part M requirements
- Spatula lever for easy flushing
- 4.5 syphon flush with delay fill

See Contour 21 Price Guide for complete range of products and codes



Contour 21
Rimless wall hung WC (S307601)

- Rimless pan
- Standard projection
- Compliant with Part M and HTM64 requirements
- Available with 4.5 single flush or 4.5/3 dual flush

See Contour 21 Price Guide for complete range of products and codes



Contour 21
Rimless wall hung WC (S307701)

- Rimless pan
- 70cm extended projection
- Compliant with HTM64 requirements
- Available with 4.5 single flush or 4.5/3 dual flush

See Contour 21 Price Guide for complete range of products and codes



Contour 21
Rimless wall hung WC (S307801)

- Rimless pan
- 75cm extended projection
- Compliant with Part M requirements
- Available with 4.5 single flush or 4.5/3 dual flush

See Contour 21 Price Guide for complete range of products and codes

Contour 21
 Schools 305mm back-to-wall WC (S304601)
 Schools 355mm back-to-wall WC (S304701) *Not shown*

- Lowered height for use by young children
- Can also be used as a back-to-wall WC
- Available with 4/2.6 dual flush

See Contour 21 Price Guide for complete range of products and codes



Contour 21
 Schools 305mm close coupled WC (S304601)

- Lowered height for use by young children
- Can also be used as a back-to-wall WC
- Available with 4/2.6 dual flush

See Contour 21 Price Guide for complete range of products and codes



Contour 21
 Schools 355mm close coupled WC (S304701)

- Lowered height for use by older children
- Can also be used as a back-to-wall WC
- Available with 4/2.6 dual flush

See Contour 21 Price Guide for complete range of products and codes





Contour 21
Back-to-wall WC (S309501)

- New from Armitage Shanks
- Suitable for residential/domestic installations
- Available with 6/4 or 4/2.6 dual flush

See Contour 21 Price Guide for complete range of products and codes



Contour 21
Close coupled WC (S309201)

- New from Armitage Shanks
- Suitable for residential/domestic installations
- Available with 6/4 or 4/2.6 dual flush

See Contour 21 Price Guide for complete range of products and codes



Wentworth
Close coupled WC pan (S316201)

- New from Armitage Shanks
- Standard height for general use
- Standard projection
- 6 litre syphon flush with side lever

See Contour 21 Price Guide for complete range of products and codes

Contour 21 Brassware



Contour 21 Dual control thermostatic shower mixer (A4127AA)

- Twin lever control
- Wall mounted
- Suitable for concealed supply pipes

See Contour 21 Price Guide for complete range of products and codes



Contour 21
Single lever thermostatic bath mixer (A4135AA)

- Sequential control
- Closed fist use, suitable for Part M applications
- Wall mounted
- Suitable for concealed supply pipes
- TMV 3 approved

See Contour 21 Price Guide for complete range of products and codes



Contour 21
Thermostatic basin mixer (A4131AA)

- Single lever operation
- Closed fist use, suitable for Part M applications
- Suitable for concealed supply pipes
- TMV 3 approved

See Contour 21 Price Guide for complete range of products and codes



Contour 21
Thermostic basin mixer (A4169AA)

- Single lever operation
- Closed fist use, suitable for Part M applications
- Suitable for concealed supply pipes
- Copper trails
- TMV 3 approved

See Contour 21 Price Guide for complete range of products and codes





Contour 21
Dual control exposed thermostatic bath/shower mixer (A4128AA)

- Twin lever control
- Wall mounted
- Thermal disinfection facility
- Suitable for concealed supply pipes

See Contour 21 Price Guide for complete range of products and codes

Contour 21
Single lever built-in thermostatic shower mixer (A4129AA)

- Sequential control
- Built-in design, suitable for concealed supply pipes
- Safety temperature stop
- TMV 3 approved



See Contour 21 Price Guide for complete range of products and codes

Contour 21
Single lever exposed thermostatic shower mixer (A4130AA)

- Sequential control
- Exposed design, suitable for concealed supply pipes
- Safety temperature stop
- TMV 3 approved



See Contour 21 Price Guide for complete range of products and codes

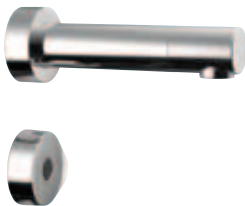

Sensorflow 21

15cm wall mounted tubular spout (A4180AA)

23cm wall mounted tubular spout (A4183AA) *Shown above*

- Ultra hygienic no-touch operation
- Separate sensor, proximity activated
- Requires pre-mixed water
- Auto flow shut off when sensor obstructed
- Mains or battery power

See Contour 21 Price Guide for complete range of products and codes



Sensorflow 21
 23cm wall mounted compact tubular spout (A4849AA)
 15cm wall mounted compact tubular
 spout (A4846AA) *Not shown*

- Ultra hygienic no-touch operation
- Built-in sensor, proximity activated
- Requires pre-mixed water
- Auto flow shut off when sensor obstructed
- Mains or battery power

See Contour 21 Price Guide for complete range of products and codes



Sensorflow 21
 Small basin spout (A4664AA)

- Ultra hygienic no-touch operation
- Reduced overall height
- Built-in sensor, proximity activated
- Requires pre-mixed water
- Auto flow shut off when sensor obstructed
- Mains or battery power

See Contour 21 Price Guide for complete range of products and codes



Sensorflow 21
 Basin spout (A4171AA)

- Ultra hygienic no-touch operation
- Built in sensor, proximity activated
- Requires pre-mixed water
- Auto flow shut off when sensor is obstructed
- Mains or battery power

See Contour 21 Price Guide for complete range of products and codes



Sensorflow 21
Deck mounted compact basin spout (A4851AA)

- Ultra hygienic no-touch operation
- Built-in sensor, proximity activated
- Requires pre-mixed water
- Auto flow shut off when sensor obstructed
- Mains or battery power

See Contour 21 Price Guide for complete range of products and codes



Sensorflow 21
Basin spout (A4176AA)

- Built in sensor, proximity flow activated
- Single lever manual temperature control
- Requires pre-mixed water
- Auto flow shut off when sensor is obstructed
- Mains or battery power

See Contour 21 Price Guide for complete range of products and codes



Sensorflow 21
15cm wall mounted cast spout (A4178AA)

- Ultra hygienic no-touch operation
- Built in sensor, proximity activated
- Requires pre-mixed water
- Auto flow shut off when sensor is obstructed
- Mains or battery power

See Contour 21 Price Guide for complete range of products and codes



Sensorflow 21
Electronic WC flush control, panel mounted (S359967)

- Proximity activated urinal flushing
- For rimmed and rimless urinal bowls
- Mains water or tank fed water
- Auto flow shut off when sensor obstructed
- Conceal cistern included
- Mains or battery power

See Contour 21 Price Guide for complete range of products and codes

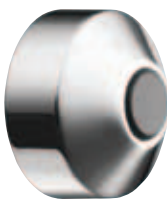

Sensorflow 21
Electronic WC flush control, surface mounted (A4669AA)

- Proximity activated urinal flushing
- For rimmed and rimless urinal bowls
- Mains water or tank fed water
- Auto flow shut off when sensor obstructed
- Mains or battery power

See Contour 21 Price Guide for complete range of products and codes

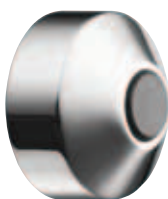

Sensorflow 21
Shower sensor and solenoid (A4185AA)

- Ultra hygienic no-touch operation
- Proximity flow activated
- Requires pre-mixed water
- Auto flow shut off when sensor obstructed
- Mains or battery power

See Contour 21 Price Guide for complete range of products and codes



Piccolo 21
Basin pillar mixers (B9142AA)

- New from Armitage Shanks
- Anti vandal outlets
- Ceramic cartridge for accurate flow control and drip free operation
- 5lt/min laminar flow regulator
- Hard wearing easy to see hot and cold temperature indicators

See Contour 21 Price Guide for complete range of products and codes



Piccolo 21
Single lever basin mixer with pop up waste (B9135AA)

- New from Armitage Shanks
- CLICK water saving cartridge
- Fitted with 5 l/min airated flow regulator
- Flow straightener option to increase flow rate at lower pressures
- Ceramic cartridge for accurate flow control and drip free operation
- Top fix fitting
- Temperature limit stop option

See Contour 21 Price Guide for complete range of products and codes



Piccolo 21
One hole bath mixer (B9138AA)

- New from Armitage Shanks
- Ceramic cartridge for accurate flow control and drip free operation
- Temperature limit stop option
- Designed for use on low or high pressure systems

See Contour 21 Price Guide for complete range of products and codes

Piccolo 21
One hole bath/shower mixer (B9139AA)

- New from Armitage Shanks
- Ceramic cartridge for accurate flow control and drip free operation
- Temperature limit stop
- Shower handset, hose and adjustable wall fixing bracket
- Designed for use on low or high pressure systems

See Contour 21 Price Guide for complete range of products and codes



Piccolo 21
Two hole bath mixer (B9140AA)

- New from Armitage Shanks
- Ceramic cartridge for accurate flow control and drip free operation
- Designed for use on low or high pressure systems

See Contour 21 Price Guide for complete range of products and codes



Piccolo 21
Two hole thermostatic bath shower mixer (A4989AA)
Two hole bath/shower mixer (B9141AA) *Not shown*

- New from Armitage Shanks
- Ceramic cartridge for accurate flow control and drip free operation
- Designed for use on low or high pressure systems
- Shower handset, hose and adjustable wall fixing bracket
- Eco button limiting flow to 50% with manual override
- Built in thermostat with cool safe to touch body
- 40°C safety stop with override facility adjustable to 43°C, 46°C or 48°C

See Contour 21 Price Guide for complete range of products and codes



Avon 21
Self closing basin mixer (B8263AA)

- Anti vandal design
- No pop-up waste
- Self closing shut off for water economy
- Closed fist use, suitable for Part M applications

See Contour 21 Price Guide for complete range of products and codes



Avon 21
Self closing basin pillar taps (B8267AA)

- Anti vandal design
- No pop-up waste
- Dual indices
- Self closing shut off for water economy
- Closed fist use, suitable for Part M applications

See Contour 21 Price Guide for complete range of products and codes

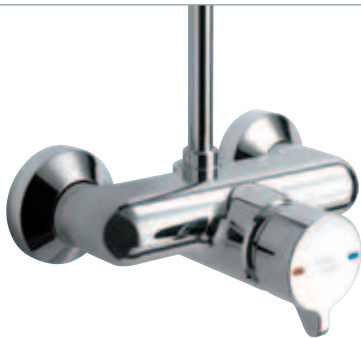

Avon 21
Self closing exposed thermostatic shower valve (B8264AA)

- Anti vandal design
- Suitable for fixed/overhead shower head
- Mixed water outlet on top
- Self closing shut off for water economy

See Contour 21 Price Guide for complete range of products and codes



Avon 21
Self closing built-in thermostatic shower valve (B8265AA)

- Anti vandal design
- Suitable for concealed supply pipework
- Self closing shut off for water economy

See Contour 21 Price Guide for complete range of products and codes



Markwik 21
Wall mounted thermostatic basin/sink mixer (A4553AA)



- For use in medical and healthcare applications
- Long single lever sequential operation
- Built in sterilisation system
- Designed in line with HTM64, HTM04 and HFN30
- TMV 3 approved



See Contour 21 Price Guide for complete range of products and codes

Markwik 21
Wall mounted thermostatic basin/sink mixer (A4554AA)



- For use in medical and healthcare applications
- Ultra hygienic proximity sensor flow start and stop
- Built in sterilisation system
- Designed in line with HTM64, HTM04 and HFN30
- TMV 3 approved



See Contour 21 Price Guide for complete range of products and codes

Markwik 21
Wall mounted thermostatic basin/sink mixer (A4555AA)



- For use in medical and healthcare applications
- Ultra hygienic proximity sensor flow start and timer controlled stop
- Built in sterilisation system
- Designed in line with HTM64, HTM04 and HFN30
- TMV 3 approved



See Contour 21 Price Guide for complete range of products and codes



Markwik 21
Single lever thermostatic basin/sink mixer (A4803AA)

- For use in medical and healthcare applications
- Long single lever sequential operation
- Insulated cool to the touch twin pillar body
- Designed in line with HTM64, HTM04 and HFN30
- Revised design eliminates swan-neck water pocket
- Easy retrofit for replacing old non-compliant fittings

See Contour 21 Price Guide for complete range of products and codes



Markwik 21
Sterilising kit for thermostatic mixers (S8293NU)

- For use with Markwik thermostatic healthcare mixers
- Easy sterilisation of healthcare mixers
- Front fixing, no need to remove fitting

See Contour 21 Price Guide for complete range of products and codes

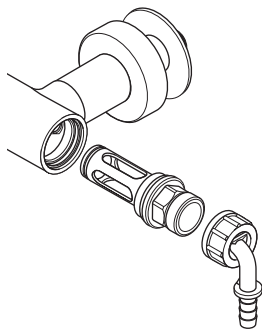

Markwik 21
Purging kit for Markwik Insulate products (A4556AA)
Purging kit (S8214AA) *Not Shown*

- For use with healthcare thermostatic mixers
- Flushes debris after installation
- Purging cartridge replaces maintenance cartridge
- Mixer can be flushed without affecting thermostat

See Contour 21 Price Guide for complete range of products and codes

Contour 21 Urinals





Contour 21
hygenIQ urinal (S611901)

- Improved hygiene performance
- Unique anti-splash cast fin, rimless bowl
- Splash back reduced by up to 90%
- 67cm overall height
- Concealed trap

See Contour 21 Price Guide for complete range of products and codes



Sanura 21
hygenIQ urinal (S611701)

- Improved hygiene performance
- Unique anti-splash cast fin, rimless bowl
- Splash back reduced by up to 90%
- 40cm overall height
- 50cm version also available
- Exposed trap

See Contour 21 Price Guide for complete range of products and codes

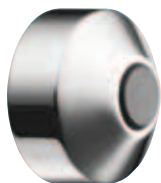

Sensorflow 21
Urinal sensor panel mounted (A4854AA)
Urinal sensor surface mounted (A4856AA)

- Proximity activated urinal flushing
- For rimmed and rimless urinal bowls
- Mains water or tank fed water
- Mains or battery power

See Contour 21 Price Guide for complete range of products and codes

Contour 21

Part M



Armitage Shanks



Sensorflow 21
Wall hung WC Doc M pack (S6987AA right hand)
(S6986AA left hand) *Not shown*

- State of the art Part M compliance
- Hygienic sensor operated basin mixer
- Hygienic sensor operated WC flush
- Extended projection WC for easier wheelchair access
- Chrome grab rails and hinged support arm
- White seat with stability retainers

See Contour 21 Price Guide for complete range of products and codes



Contour 21
Close coupled WC Doc M pack (S6967AC right hand)
(S6966AC left hand) *Not shown*

- Part M compliant, LANTAC approved
- TMV 3 approved thermostatic sequential mixer
- Right or left hand tap hole basin option
- Raised height WC for easier wheelchair access
- White, blue or stainless steel grab rails and hinged support arm
- White, blue or grey seat with stability retainers

See Contour 21 Price Guide for complete range of products and codes



Part M Solutions
What works and why







- Armitage Shanks' informative guide to Part M washrooms
- Overview of section 10.3 of Part M4 of the Building Regulations
- Scale of provision required by BS6465 and section 5.7 of Part M3
- 10 approved Part M bathroom and washroom layouts
- 10 Armitage Shanks Part M packs

See our Part M Solutions brochure for complete range of products and codes

Contour 21

Part M Grab Rails

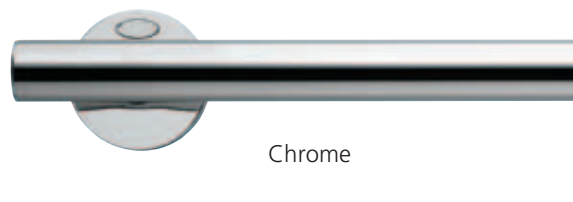

 <p>White</p>	<p>Contour 21 Fixed grab rails</p> <p>Available in white, grey, blue, charcoal, stainless steel or chrome to provide contrast with their background for visually impaired users. Each rail is made of 33mm diameter polyester coated aluminium (with the exception of the stainless steel and chrome rails), has concealed fixings for improved hygiene and security and is capable of supporting 200kg.</p>
 <p>Blue</p>	<p>Contour 21 Hinged support arm</p> <p>A robust support that folds up and out of the way, simplifying transfer from wheelchair to WC. Slip resistant contact surfaces enhance safety and promote confidence in the user. The hinged support arm can support 200kg when fixed using best practice.</p>
 <p>Stainless Steel</p>	<p>See Contour 21 Price Guide for complete range of products and codes</p>
 <p>Grey</p>	 <p>Stainless Steel</p>
 <p>Charcoal</p>	 <p>Chrome</p>

Guarantee

lifetime

All ceramic products

5 years

on taps and mixers, toilet seats and cistern fittings

Our confidence in the quality and reliability of our product allows us to offer outstanding extended guarantees on all our products – where the product fails within 5/25 years/lifetime we offer a free replacement or replacement part (or nearest equivalent). So when your washroom has been satisfactorily installed and is working well, please ensure you register your guarantee.

This guarantee is transferable – it applies to the product not the purchaser provided the guarantee registration is passed on to the new owner.

Liability is limited to individual products and the guarantee does not cover the consequential loss or damage or installation costs. This guarantee does not affect your statutory rights. Products must be installed, used and cared for in line with our fixing instructions and local water regulations, and room must be adequately ventilated.

Parts (e.g. flushvalves) are guaranteed for five years and will be replaced if found to be faulty. The guarantee does not cover general wear and tear.

Applies to UK and Republic of Ireland only.

You can register for guarantees on a bathroom bought on your behalf by a plumber or builder.

Colours printed in this book are as near as possible to the manufactured range of Armitage Shanks quality bathrooms. For accurate comparisons of colours, see actual ware on display at Armitage Shanks retailers. Our policy is one of continuous improvement and we reserve the right to change specification and design at any time without notice.

Products can be subject to tolerances due to manufacturing processes.

For further information on any of our products;

please call

0870 122 8822

or visit

www.thebluebook.co.uk

The bluebook has long been the most comprehensive guide to bathroom and washroom products. Now the bluebook DVD provides an interactive version allowing you to navigate through more than 1250 pages of detailed drawings and specifications instantly. Once installed on your hard drive blue book can be automatically updated with the latest product information every time you go online.

A division of Ideal Standard (UK) Ltd.

© Armitage Shanks
P1453 01/11

additional resources

Further information about the Disability Discrimination Act is available from the following organisations.

Department for Work & Pensions
www.dwp.gov.uk

Disability Rights Commission
www.drc-gb.org

Direct Gov
www.direct.gov.uk

technical helpline

0870 122 8822

the essential specifiers series



If you would like to request the Hospital, Brassware, Part M, School, Office, Contour 21, Hotel or Trade Price List brochures from our 'Essential Specifiers Series',

call 0800 590311

*Armitage
Shanks*