

## Aridian waterless urinal

For more information  
please contact  
our Technical Helpline on  
0870 122 8822

Armitage Shanks  
Armitage  
Rugeley  
Staffordshire  
WS15 4BT  
Tel: 01543 490253  
Fax: 01543 491677  
[www.thebluebook.co.uk](http://www.thebluebook.co.uk)

*Armitage  
Shanks*

P616 8/04

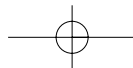

CI/SfB  
August 2004

(74)

## Aridian waterless urinal

For a cleaner, greener environment

*Armitage  
Shanks*

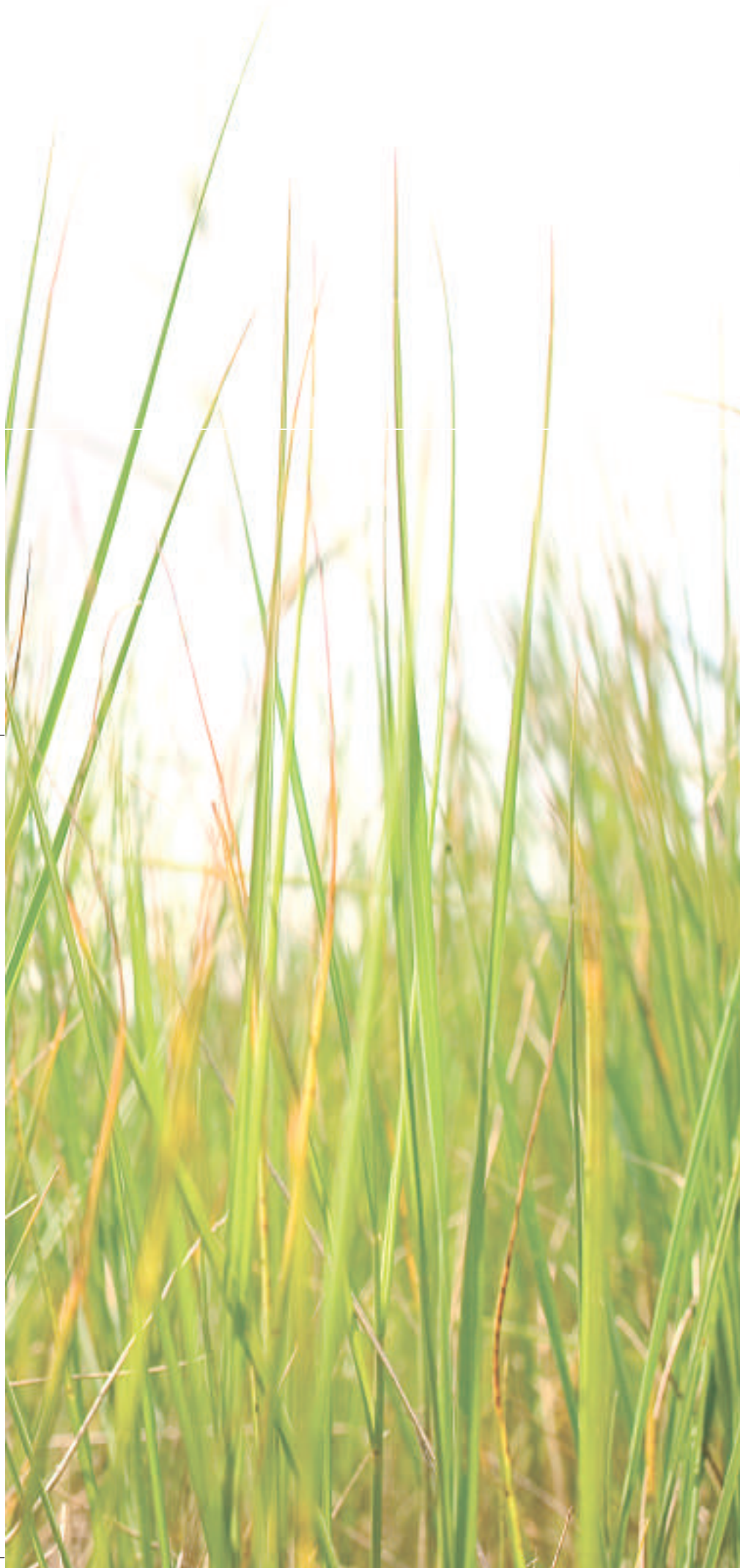



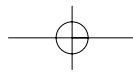
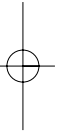
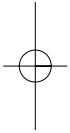
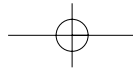

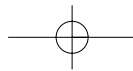

## Aridian Introduction

For a cleaner, greener environment.



Water, our most precious resource, is more and more in demand. As water usage and the costs associated with it continue to rise, architects, planners and environmentalists around the world are looking for new alternatives.

Aridian, a revolutionary waterless urinal, is one of those alternatives. In addition to saving water, its proven technology offers key advantages over conventional water flushing urinals, including cheaper installation, easier maintenance and better hygiene.

### Contents

Aridian benefits	4
How it works	6
Maintenance	8
Questions and answers	10
Testimonials	12
Product & technical information	14

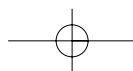

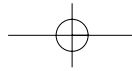

## Aridian The benefits

Aridian's waterless technology offers an array of significant benefits, including:

**Water saving** On average, each Aridian urinal helps to save 150,000 litres of water a year: a massive saving of an increasingly scarce and expensive resource.

**Ease of installation** Aridian is quicker, easier and cheaper to install than conventional urinals, needing no cistern, flush pipes or bottle trap.

**Lower maintenance** The absence of mechanical components such as cisterns, flushpipes and sensors mean that Aridian needs less maintenance than conventional flushing units. Under average use conditions Aridian's cartridge only needs replacing four times per year.

There is also no need to close down washrooms to eliminate salt build up in pipe work and there is no danger of flooding issues or water pressure drop during large useage.

**Reduced odour** Tests carried out at The University of California in Los Angeles concluded that the Aridian waterfree urinal reduced unpleasant odours and had lower levels of bacteria than a flush urinal.

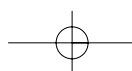



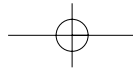

In 24-hour continual usage situations such as airports, managers appreciate Aridian's low maintenance needs.

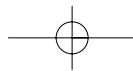

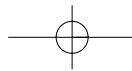

## Aridian How does it work?

Like many great ideas, Aridian is based around simplicity. Installed in minutes and lasting years, it requires only minimal maintenance. But how does it actually work?

Urine which is 96% water, flows down the surface of the urinal and into the unique Sealtrap cartridge. The cartridge is filled with a special liquid called Allseal, which is not only perfumed, but prevents foul air from rising up from the drain and into the washroom. It does this by floating on the surface inside the cartridge and trapping any particles at the cartridge base.



The Sealtrap cartridge - urine flows down the surface of the urinal and into the cartridge which is filled with a special liquid called Allseal. Foul air is prevented from rising up from the drain and into the washroom.

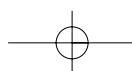
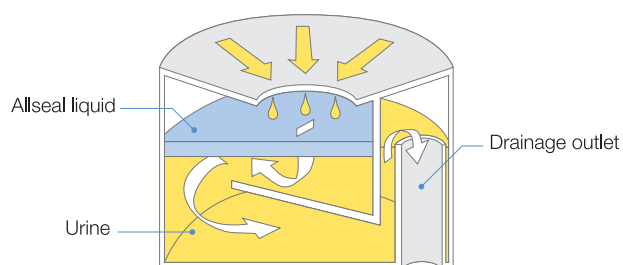



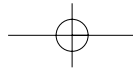

Waterless technology has been effective in stadia and concert halls when demand for washrooms is heavy during intervals.

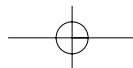
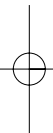



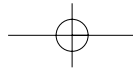

## Aridian Maintenance made easy

Aridian's essential simplicity, with no mechanical components, make it much easier to maintain than conventional flushing urinals.

Regular cleaning of Aridian consists of spraying on cleaner, wiping it off, and that's it. No water is needed for every-day cleaning.\* Replacing cartridges, a simple job, only has to be carried out every three months under average use conditions. Full cleaning and maintenance instructions are included with all Aridian units.

### Maintenance partners

To make it simpler still, you can arrange to have your Aridian units maintained by one of Armitage Shanks's maintenance partners. Specially trained by Armitage Shanks, our maintenance partners can take care of every aspect of looking after your urinals, including replacement cartridges and, in the unlikely event of a problem, emergency call outs. For more details on our maintenance partners please contact our technical helpline on 0870 122 8822.

\* Water is needed when replacing the cartridge.

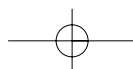

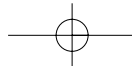

Aridian's reduced odour and greater hygiene make it ideal for use in school and sports environments.

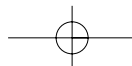
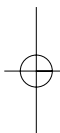



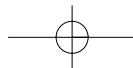

## Aridian Questions and answers

**Q** What are the advantages of the Waterless Urinal System?

**A** Since water isn't required, you make substantial water and sewage cost savings. Also, maintenance expenses are reduced since there are no mechanical components such as cisterns, flush pipes etc.

**Q** How can a urinal bowl be hygienic without water present?

**A** In scientific tests, waterless urinals had a significantly lower bacterial count on the surface of the bowl than the flush variety. This is because water provides a breeding ground for bacteria - waterless urinals help prevent the harbouring and growth of bacteria.

**Q** What about odour?

**A** The absence of water prevents a chemical reaction between urine and water (ammonia oxide), thereby avoiding the strong odour that follows.

**Q** Can a carelessly discarded cigarette butt affect the urinals effectiveness?

**A** No. Because it has such a small inlet opening, the cigarette butt remains on the trap cartridge and can be removed quickly by janitorial staff.

**Q** Does the undiluted urine have a detrimental effect on plumbing materials?

**A** Experts, including NASA scientists, have concluded that acids present in urine have no impact on common plastic or metal materials used in drainage systems.

**Q** What are the new installation requirements?

**A** One of the advantages to this system is that the installation of water pipes and automatic cistern isn't necessary, resulting in lower installation costs. All other installation requirements are in line with best plumbing practice, ie. Air emittance valve, 2% minimum fall on waste pipework and ensuring existing pipework is clean and obstruction free. Full installation instructions are included with all Aridian units.

**Q** Is it vandal proof?

**A** Aridian is available with an optional metal cover plate with anti tamper screws, to prevent access to the underside of the unit.

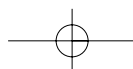

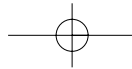

Aridian's easy installation helps to keep time and costs to a minimum.

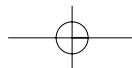
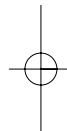
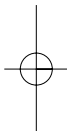



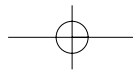

## Aridian Testimonials

There are already thousands of people benefitting from Aridian's waterless technology, in sites all around the globe, from the Taj Mahal to Shanghai Airport. Here's what some of them have to say...

"The waterfree urinals have performed well with heavy usage, require little maintenance and provide Rose Bowl patrons with clean, odour-free amenities that have the added benefit of conserving water."

**Darryl Dunn, General Manager of the Rose Bowl Stadium,  
Pasadena, California**

"The waterfree urinals work...the units are easy to install and maintain...it is safe to say we will be installing more."

**Bob Baker, Director of Engineering, Xanterra Parks and Resorts, Grand  
Canyon National Park**



"They are easy to maintain and reduce problems associated with stuck valves and accidental or intentional flooding."

**Portland General Electric**

"US Department of Energy lists waterfree urinals as a best management practice for all new and retrofit school designs."

**National Best Practices Manual for Designing High Performance Schools**

"We are thrilled with the waterfree system. It is saving the district tremendous amounts of water and energy and has significantly reduced our maintenance costs as well."

**Ted Rozzi, Assistant Superintendent of Facilities, Corona Norco  
School District**

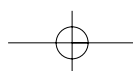

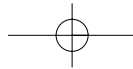

As part of their innovative water conservation programme the Central Basin Municipal Water District in South-East Los Angeles offers free supply and fitting of waterless urinals to replace conventional units.

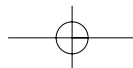
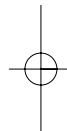
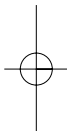



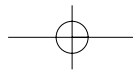

## Aridian Product and technical information

### Aridian Waterless urinal and divider

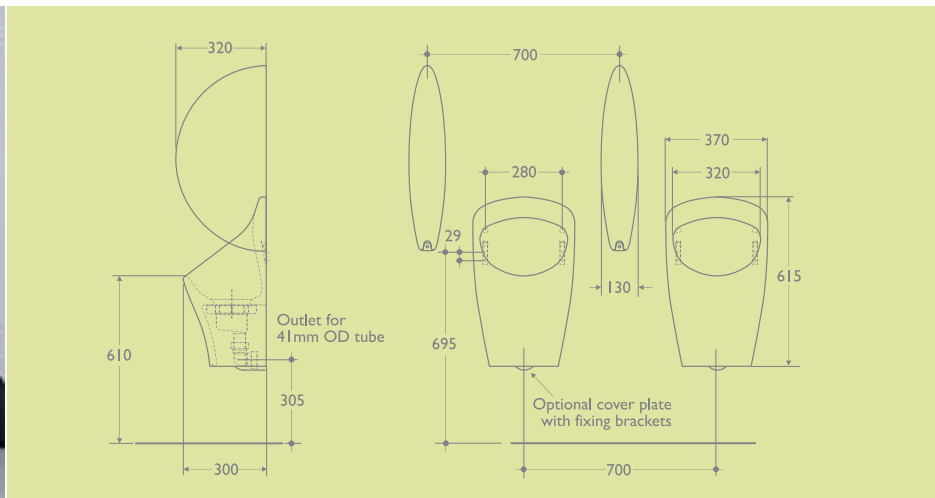

### Kinloch Stainless steel waterless urinal

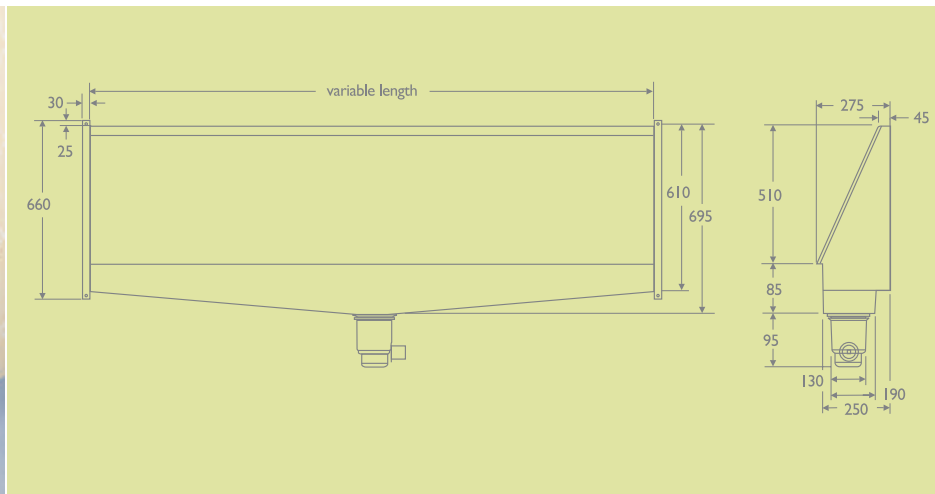

Kinloch is the stainless steel trough version of Aridian. Utilising the same waterless technology, its stainless steel finish make it particularly suited to situations calling for extra durability.

- S632101 Aridian Waterless Urinal, complete with 1 cartridge, Adapter & Fixings
- S613067 Aridian Urinal Coverplate
- S612001 Urinal Division with hanger & Screw
- S628267 Waterless Cartridge - single
- S628367 Waterless Cartridges - Box of 32

#### Kinloch Waterless

- S6147MY Kinloch Stainless Steel Waterless trough 1200mm, centre outlet
- S6148MY Kinloch Stainless Steel Waterless trough 1800mm, centre outlet
- S6149MY Kinloch Stainless Steel Waterless trough 2400mm, centre outlet

#### Bespoke Lengths

- S6137MY Kinloch Stainless Steel Waterless trough 600 - 1200mm
- S6138MY Kinloch Stainless Steel Waterless trough 1201 - 1800mm
- S6139MY Kinloch Stainless Steel Waterless trough 1801 - 2400mm
- S6178MY Stainless Steel shroud for outlet

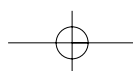

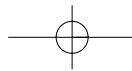

### Comparison with conventional urinals

Item	How Aridian compares
Initial product cost	Lower in average situation
Installation cost	Lower - less plumbing required
System complexity	Simpler
Flushing reliability	No flushing required
Fresh water consumed	Zero
Odour potential	Lower - no water for urine to react with
Operating costs	Lower - no water purchase, sewage treatment or odour control costs
Maintenance costs	Lower - no leaks or scaling
Maintenance down time	Negligible
Vandalism susceptibility	Lower - due to absence of hardware
Environmental impact	Better - reduced water use

### Water savings versus conventional urinals

#### Type of installation

3 urinals  
flushing 4 times per hour  
Fed by 9 litre auto cistern

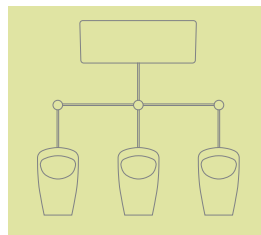

1 urinal  
flushing 4 times per hour  
Fed by 4.5 litre cistern

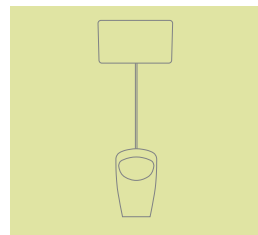

1 urinal  
flushing 6 times per hour  
Fed by 4.5 litre cistern

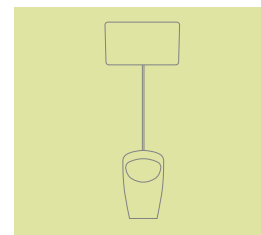

Total annual water saving	315,360 litres	157,680 litres	236,520 litres
Annual water saving per urinal	105,120 litres	157,680 litres	236,520 litres