



The perfect commercial partnership



Pegler is an expert in the production of Taps, Mixers and Valve products. It boasts an unrivalled track record for integrity, quality, reliability and innovation.



Yorkshire is a specialist in the production of metal plumbing and heating fittings. It has an established reputation for manufacturing quality products.



LUXURY TAP SOLUTIONS



HEATING CONTROLS



VALVES AND FITTINGS



UTILITY TAP SOLUTIONS



INTEGRAL SOLDER RING FITTINGS



THE PUSH-FIT JOINTING SYSTEM



THE PRESS-FIT JOINTING SYSTEM



COMPRESSION FITTINGS



END FEED FITTINGS



COMMERCIAL VALVES

PERFORMA

Utility Tap Solutions

For further information, please contact your appropriate Sales Office

UK

Northern team:
Telephone: 0870 1200281 Fax: 01302 560108

Southern team:
Telephone: 0870 1200282 Fax: 01302 560458

Western team:
Telephone: 0870 1200283 Fax: 01302 560109

Eastern team:
Telephone: 0870 1200282 Fax: 01302 560458

Email: uk.sales@pegler.co.uk

EXPORT

Telephone: +44 (0) 1302 855656

Fax: +44 (0) 1302 730513

Email: export@pegler.co.uk

Technical helpline: 0870 1200285



Pegler

Pegler Limited, St. Catherine's Avenue, Doncaster, South Yorkshire, DN4 8DF, England.

www.pegler.co.uk

Registered Company No. 01194543. Place of Registration: England

All brand names and logo styles are registered trademarks.

Maintaining a policy of continual product development, Pegler Ltd reserve the right to change specifications, design and materials of products listed in this databook without prior notice. LIT.REF: 880103.02.07

PERFORMA

Utility Tap Solutions



Pegler



Manufacturing

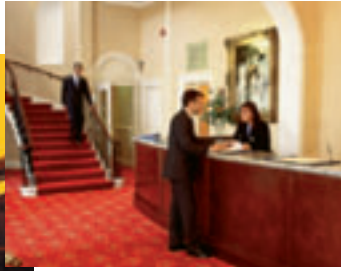

Hotels



Airports



Social Housing



Offices



Leisure Centres

PERFORMA TAP SOLUTIONS



Education



Public Houses



Prisons

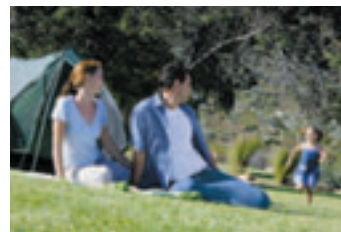

Camp Sites



Hospitals



Retail/Shops



Petrol/Service Stations

PEGLER QUALITY, SERVICE AND VALUE FOR MONEY. OVER 100 YEARS IN THE MAKING.

It is not by chance that Pegler is respected the world over as one of the leading manufacturers of high quality plumbing and heating products of the modern age.

Established in 1899 and proud of its great tradition, the company has evolved and grown over a period of which few others can boast.

Today, by maintaining the high standards of quality, innovation and customer service that are the envy of its competitors worldwide, Pegler remains at the forefront of the industry.

One of the many rewards has been BS EN ISO 9002 (BS 5750) Quality Assurance accreditation. Where appropriate, Pegler products also bear the Kitemark to indicate compliance with British Standards.

QUALITY

By using only the very best materials currently available, advanced manufacturing processes and applying the most stringent quality control standards, Pegler consistently delivers outstanding product reliability. This in turn means the assurance of a long working life and unbeatable value for money.

WATERTIGHT GUARANTEE

When you purchase or specify any Performa product, you are acquiring far more than a means of doing a job well. You are investing in unrivalled quality, service, value and reliability that has been over 100 years in the making. And that is why only Pegler gives you the added assurance of the unique watertight guarantee of quality.

- Robust designs backed by 5 year guarantee.
- Engineering excellence ensures reliability and durability.
- Suitable for a wide variety of applications.
- Backing of a full spares programme.
- Easy to service and maintain.
- Value for money.
- Products that will not under perform or let you down.



CONTENTS

DOMESTIC AND LIGHT COMMERCIAL TAPS AND MIXERS

Leger Bathroom & Kitchen Taps & Mixers	Pages 5-7
Souvenir Bathroom & Kitchen Taps & Mixers	Pages 8-9
Peglerflow Single Lever Bathroom Taps & Mixers	Page 10
Danum & Danum DCD Bathroom & Kitchen Taps & Mixers	Pages 11-13
Polo Bathroom & Kitchen Taps & Mixers	Pages 14-15
Performa Cross Top Bathroom & Kitchen Taps & Mixers	Pages 16-18
Performa Lever Handle Bathroom & Kitchen Taps & Mixers	Pages 19-21

HEALTHCARE TAPS AND MIXERS

General Healthcare Lever Handle Sink & Basin Taps	Pages 23-26
Kliniklene Lever Handle Sink & Basin Taps	Pages 27-31

WATER SAVING FLOW CONTROLS

ECO Basin Taps	Pages 33-34
Self-closing Basin Taps and Mixers	Pages 35-40
Lever Operated Monobloc Basin Mixer	Page 41
Lever Operated Flow Control	Page 42
Electronic Basin Outlets	Pages 43
Monobloc Electronic Basin Mixers	Page 44
Electronic Accessories	Page 45
Self-closing Shower Controls	Page 46
Shower Risers and Heads	Page 47
In-line Mixing Valves	Pages 48-49
Urinal Flush Controllers	Page 50
Accessories	Page 51

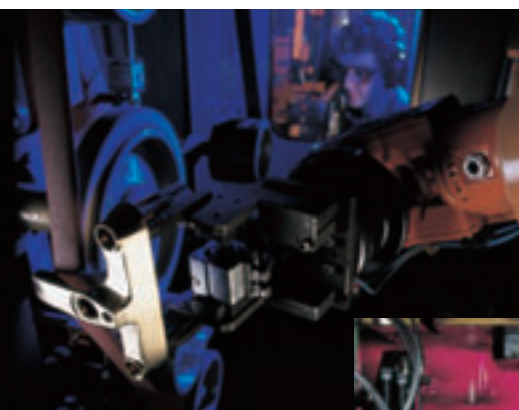

PERFORMA

DOMESTIC AND LIGHT COMMERCIAL TAPS AND MIXERS

THE PERFORMA RANGE OF TAPS AND MIXERS

In Performa, Pegler is proud to offer a comprehensive range of user-friendly and cosmetically appealing products to suit a wide variety of applications. The Performa domestic and light commercial portfolio comprises 9 distinctly different ranges which includes both bathroom and kitchen taps and mixers.

Performa products are designed and manufactured to provide low pressure operation and high flow performance, using up-to-the-minute technology such as ceramic disc cartridges.

The enduring quality and performance offered by Performa products is reflected by the availability of a range of Kitemarked products to BS1010 and BS5412 standards.

- Robust designs backed by 5 year guarantee.
- Engineering excellence ensures reliability and durability.
- Valve options include the traditional washed valve and ceramic disc technology.
- Suitable for a wide variety of applications covering bathrooms and kitchens.
- Backing of a full spares programme.
- Easy to service and maintain.
- Value for money.
- Products that will not under perform or let you down.



Pegler

PERFORMA LEGER

BATHROOM & KITCHEN TAPS & MIXERS

- Quarter turn ceramic disc technology
- Low pressure operation
- Designed handles for easy operation
- Contemporary aesthetics
- Bold colour markings for easy identification
- Kitchen and bathroom offerings
- Interchangeable handles and headworks
- Brass backnuts (where applicable)



LEVER HANDLE BATHROOM TAPS & MIXERS

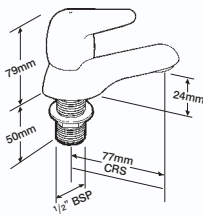

L153 1/2" BASIN TAPS

FINISH
CHROME

ORDER CODE
4B7001

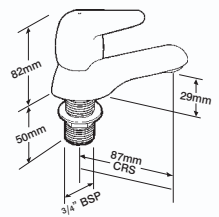

L153 3/4" BATH TAPS

FINISH
CHROME

ORDER CODE
4B7002

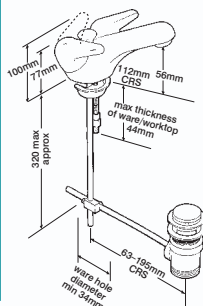

L565 MONOBLOC BASIN MIXER WITH POP-UP WASTE

FINISH
CHROME

ORDER CODE
4B7004

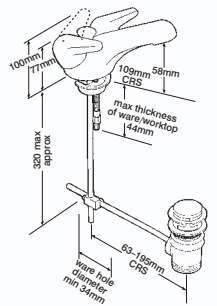

L567 MONOBLOC BASIN FILLER WITH POP-UP WASTE (DUALFLOW)

FINISH
CHROME

ORDER CODE
4B7003

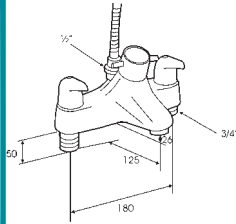

L555 THERMOSTATIC BATH/SHOWER MIXER (LESS KIT)

(SEE PAGE 12 FOR SHOWER KITS)

FINISH

CHROME

ORDER CODE

4B7008

L555 Operating Requirements

min inlet pressure:	0.1 bar dynamic
max inlet pressure:	6.0 bar dynamic
max pressure loss ratio:	5:1
max temperature of incoming hot water:	65°C

Performance Characteristics

maintains water temperature within 2°C.
designed in accordance with BS5412, BS1111 and BS1287.
chrome plated to comply with BS1224

LEVER HANDLE KITCHEN TAPS

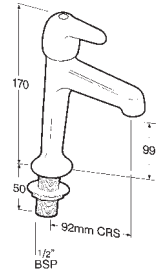

L502 1/2" HIGH NECK SINK TAPS

FINISH

CHROME

ORDER CODE

4B7009

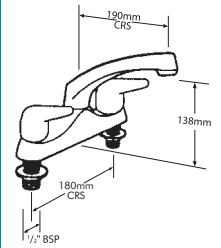

L521 DECK SINK MIXER (DUAL FLOW) WITH CAST SPOUT

FINISH

CHROME

ORDER CODE

4B7011

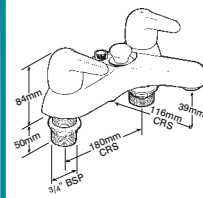
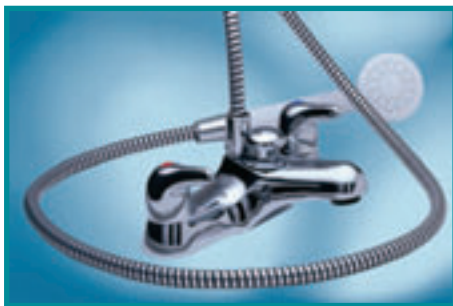

L550 DECK BATH/SHOWER MIXER (LESS KIT)

(SEE PAGE 12 FOR SHOWER KITS)

FINISH

CHROME

ORDER CODE

4B7005

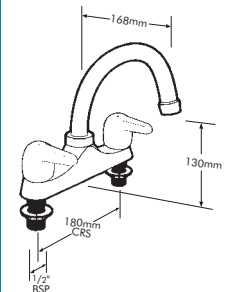

L522 DECK SINK MIXER (DUAL FLOW) WITH TUBULAR SPOUT

FINISH

CHROME

ORDER CODE

4B7013

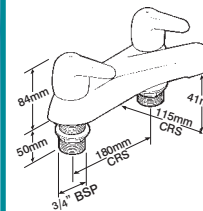

L557 DECK BATH FILLER (DUALFLOW)

FINISH

CHROME

ORDER CODE

4B7006

LEGER BATHROOM AND KITCHEN TAPS AND MIXERS FLOW CHARTS

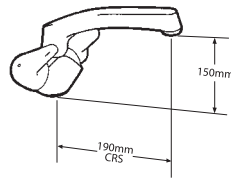

L525 DECK SINK MIXER (DUAL FLOW) WITH CAST SPOUT

FINISH
CHROME

ORDER CODE
4B7012

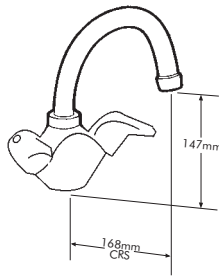
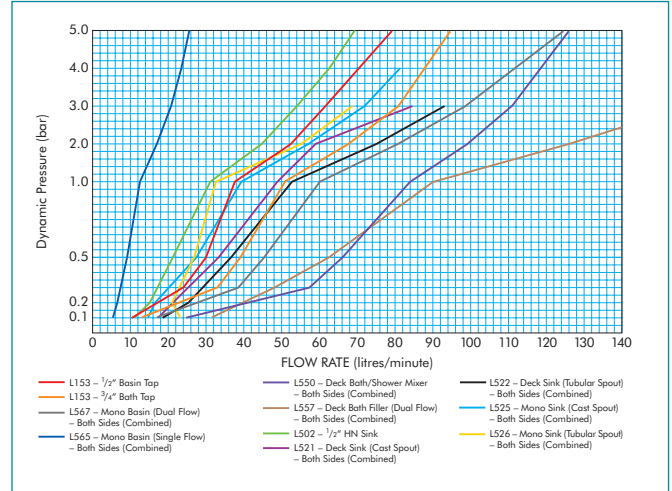

L526 DECK SINK MIXER (DUAL FLOW) WITH TUBULAR SPOUT

FINISH
CHROME WITH FLEXIBLE TAILS
CHROME WITH COPPER TAILS

ORDER CODE
4B7010
4B7014

L555 LEGER THERMOSTATIC BATH/SHOWER MIXER FLOW CHART

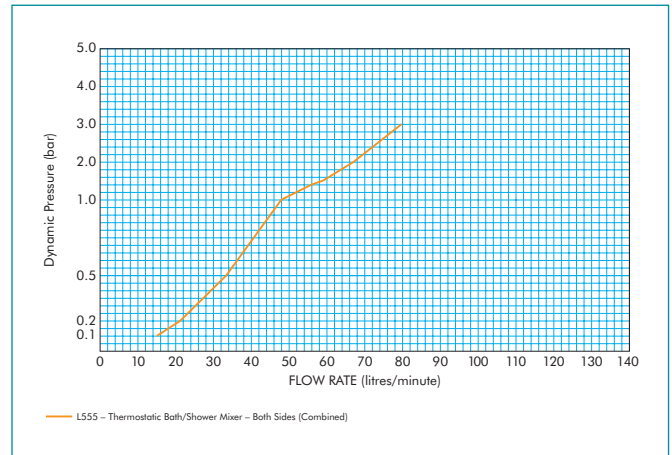

- Recommended working temperature 65°C maximum
- Uses WRAS approved materials
- Minimum working pressure on ceramic disc cartridges 0.1 bar (Dynamic)
- Maximum working pressure on ceramic disc cartridges 6.0 bar (Static)
- Endurance tested to minimum of 200,000 cycles

PERFORMA SOUVENIR

BATHROOM & KITCHEN TAPS & MIXERS

- Compression type washered valves
- Low pressure operation
- Traditional rounded styling
- Kitchen and bathroom offerings
- Comprehensive range
- Brass backnuts (where applicable)



BATHROOM TAPS & MIXERS

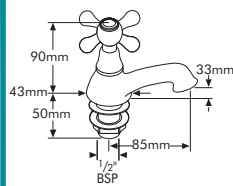

1/2" BASIN TAPS

FINISH
CHROME

ORDER CODE
4W9041

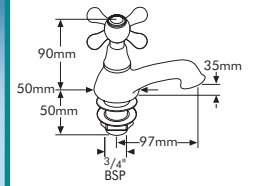

3/4" BATH TAPS

FINISH
CHROME

ORDER CODE
4W9042

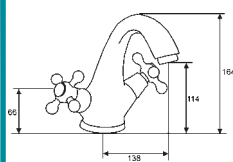

MONOBLOC BASIN MIXER WITH POP-UP WASTE

FINISH
CHROME

ORDER CODE
4W9047

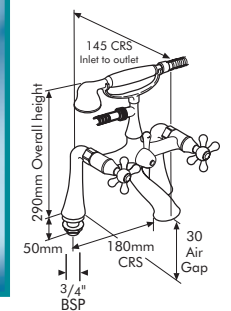

BATH/SHOWER MIXER (WITH KIT)

FINISH
CHROME

ORDER CODE
4W9043

KITCHEN TAPS & MIXERS

SOUVENIR BATHROOM AND KITCHEN TAPS AND MIXERS FLOW CHARTS

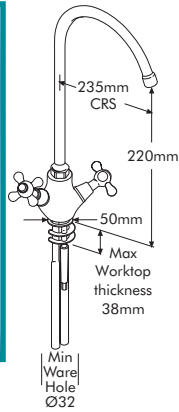

MONOBLOC KITCHEN MIXER WITH TUBULAR SPOUT

FINISH
CHROME

ORDER CODE
4W9045

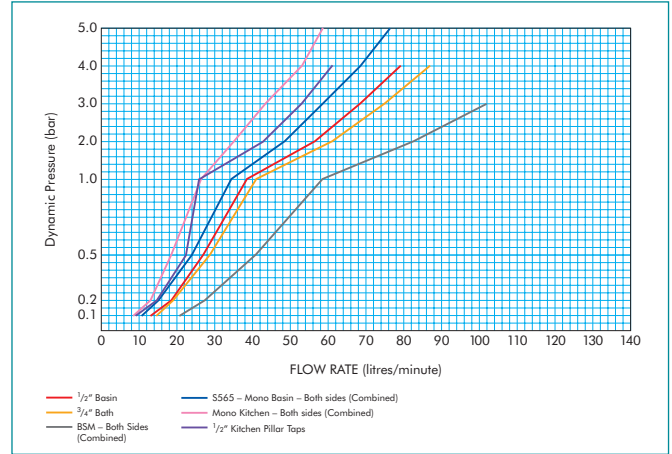

- Recommended working temperature 60°C maximum
- Uses WRAS approved materials
- Minimum working pressure on washered valves 0.1 bar (Dynamic)
- Maximum working pressure on washered valves 10 bar (Static)
- Endurance tested to minimum of 200,000 cycles

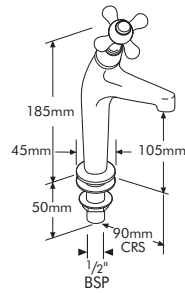

1/2" KITCHEN PILLAR TAPS

FINISH
CHROME

ORDER CODE
4W9046

PERFORMA PEGLERFLOW SINGLE LEVER BATHROOM TAPS & MIXERS

- Single lever ceramic disc for easy operation
- European contemporary styling
- Compact dimensions to suit the smaller luxury bathroom

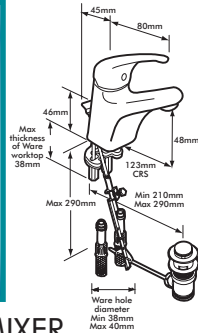

S565 CP MONOBLOC BASIN MIXER WITH POP UP WASTE

FINISH
CHROME

ORDER CODE
4J4001

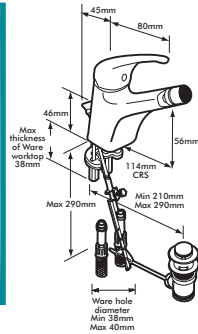

S593 CP MONOBLOC BIDET MIXER WITH POP UP WASTE

FINISH
CHROME

ORDER CODE
4J4002

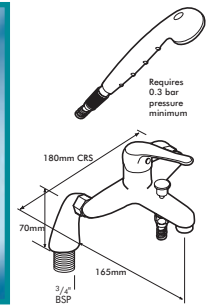

S550 DECK MOUNTED BATH/SHOWER MIXER (WITH KIT)

FINISH
CHROME

ORDER CODE
4J4004

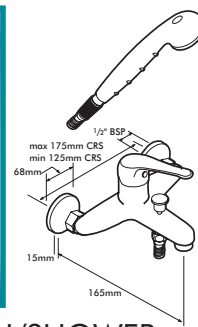

S651 CP WALL MOUNTED BATH/SHOWER MIXER WITH KIT

FINISH
CHROME

ORDER CODE
4J4003

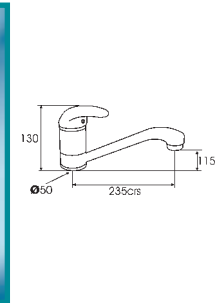

SINGLE LEVER MONOBLOC SINK MIXER

FINISH
CHROME

ORDER CODE
4J4011

PEGLERFLOW SINGLE LEVER BATHROOM TAPS AND MIXERS FLOW CHARTS

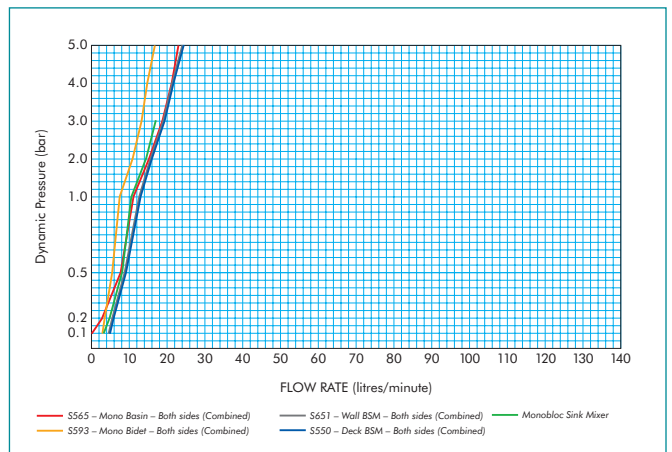

- Recommended working temperature 60°C maximum
- Uses WRAS approved materials
- Minimum working pressure on single lever cartridge 0.3 bar (Dynamic)
- Maximum working pressure on single lever cartridge 5.0 bar (Static)
- Endurance tested to minimum of 200,000 cycles

PERFORMA DANUM & DANUM DCD BATHROOM & KITCHEN TAPS & MIXERS

- Choice of quarter turn ceramic disc or compression type washed valves
- Low pressure operation
- Modern, compact design
- Both kitchen and bathroom offerings
- Interchangeable handles and headworks
- Brass backnuts (where applicable)



BATHROOM TAPS & MIXERS

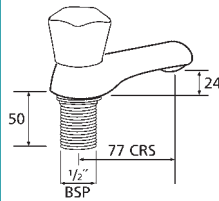

5153/153 1/2" BASIN TAPS

FINISH

CHROME
CHROME (DCD)

ORDER CODE

404010
404068

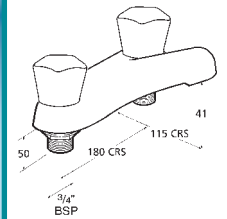

5557 BATH FILLER (DUALFLOW)

FINISH

CHROME

ORDER CODE

430010

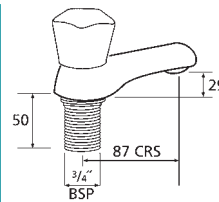

5153/153 3/4" BATH TAPS

FINISH

CHROME
CHROME (DCD)

ORDER CODE

405010
405069

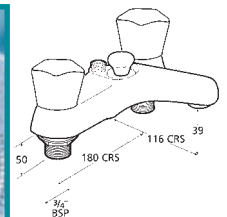

5550/550 BATH/SHOWER MIXER (LESS KIT)
(SHOWER KITS SHOWN PAGE 12)

FINISH

CHROME
CHROME (DCD)

ORDER CODE

427010
427011

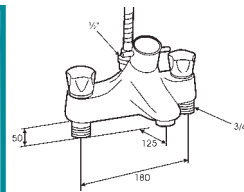

DANUM BATH/THERMOSTATIC SHOWER MIXER FLOW CHART

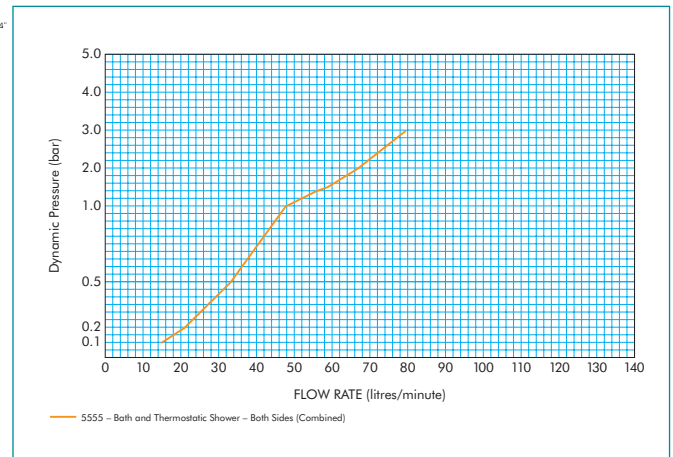

5555 BATH & THERMOSTATIC SHOWER MIXER (LESS KIT) (SHOWER KITS SHOWN BELOW)

FINISH	ORDER CODE
CHROME	431010

5555 Operating Requirements

min inlet pressure:	0.1 bar dynamic
max inlet pressure:	10.0 bar dynamic
max pressure loss ratio:	5:1
max temperature of incoming hot water:	65°C

Performance Characteristics

maintains water temperature within 2°C.
designed in accordance with BS5412, BS1111 and BS1287.
chrome plated to comply with BS1224

SHOWER KITS



KIT 1 – HANDSPRAY, 1.5M HOSE & WALL BRACKET

FINISH	ORDER CODE
CHROME	467001

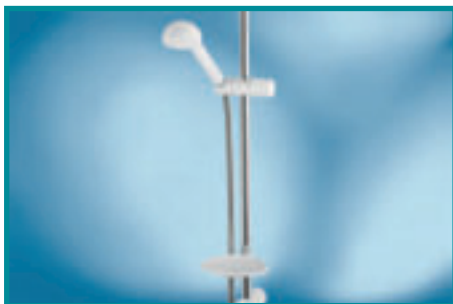

KIT 3 – HANDSPRAY, 1.5M HOSE & SLIDER RAIL

FINISH	ORDER CODE
CHROME	467003

KITCHEN TAPS & MIXERS

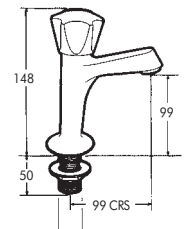

5150/150 HIGH NECK SINK TAPS

FINISH WITH TRADITIONAL HANDLES	ORDER CODE
CHROME	401018
CHROME (DANUM DCD)	406068

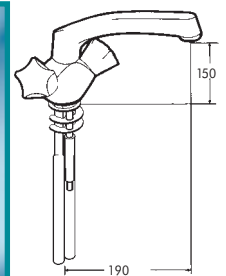

5525 MONOBLOC SINK MIXER WITH CAST SPOUT (DUALFLOW)

FINISH WITH TRADITIONAL HANDLES	ORDER CODE
CHROME	408001

DANUM BATHROOM AND KITCHEN TAPS AND MIXERS FLOW CHARTS

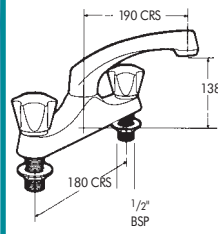

5521/521 DECK SINK MIXER WITH CAST SPOUT (DUALFLOW)

FINISH WITH TRADITIONAL HANDLES

ORDER CODE

CHROME	412001
CHROME (DANUM DCD)	412002

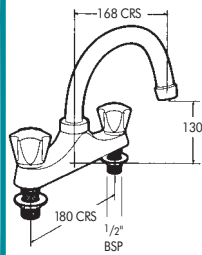
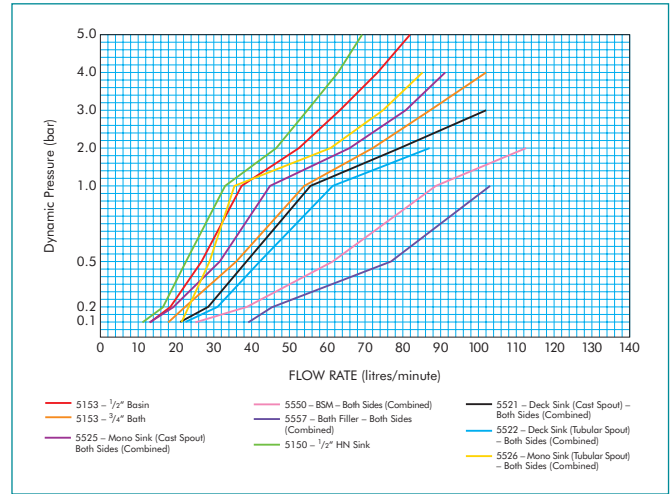

5522/522 DECK SINK MIXER WITH TUBULAR SPOUT (DUALFLOW)

FINISH WITH TRADITIONAL HANDLES

ORDER CODE

CHROME	413001
CHROME (DANUM DCD)	413002

DANUM DCD BATHROOM AND KITCHEN TAPS AND MIXERS FLOW CHARTS

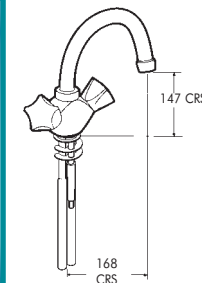
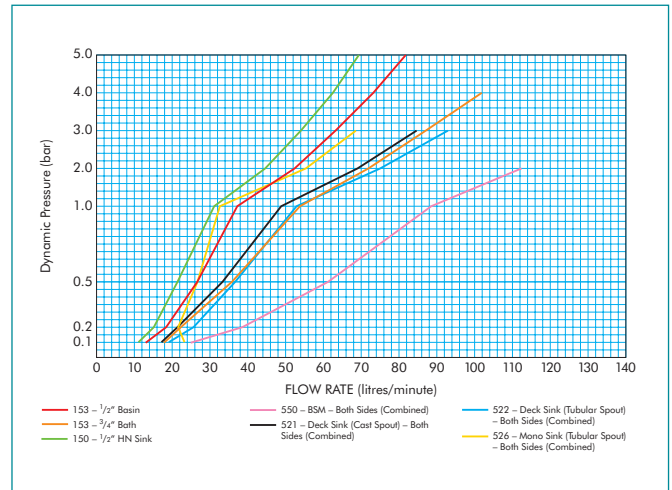

5526/526 MONOBLOC SINK MIXER WITH TUBULAR SPOUT (DUALFLOW)

FINISH WITH TRADITIONAL HANDLES

ORDER CODE

CHROME	409001
CHROME (DANUM DCD)	409002

- Recommended working temperature 65°C maximum
- Uses WRAS approved materials
- Minimum working pressure on ceramic disc cartridges 0.1 bar (Dynamic)
- Maximum working pressure on ceramic disc cartridges 6.0 bar (Static)
- Minimum working pressure on washered valves 0.1 bar (Dynamic)
- Maximum working pressure on washered valves 10 bar (Static)
- Endurance tested to minimum of 200,000 cycles

PERFORMA POLO

BATHROOM & KITCHEN TAPS & MIXERS

- Compression type washered valves
- Low pressure operation
- High value at low cost
- Contemporary design
- Kitchen and bathroom offerings



BATHROOM TAPS & MIXERS

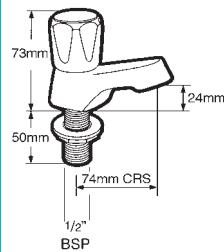

P501 1/2" BASIN TAPS

FINISH
CHROME

ORDER CODE
434004

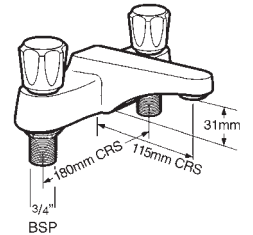

P557 BATH FILLER

FINISH
CHROME

ORDER CODE
441002

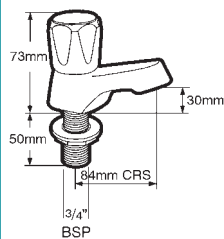

P501 3/4" BATH TAPS

FINISH
CHROME

ORDER CODE
434027

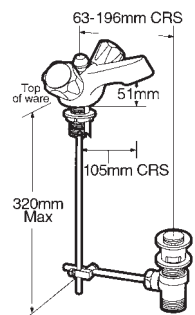

P565 MONOBLOC BASIN MIXER WITH POP UP WASTE

FINISH
CHROME

ORDER CODE
444002

POLO BATHROOM AND KITCHEN TAPS AND MIXERS FLOW CHARTS



P550 BATH & SHOWER MIXER (WITH KIT)

FINISH
CHROME

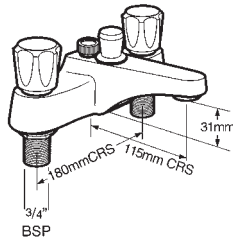

ORDER CODE
439002

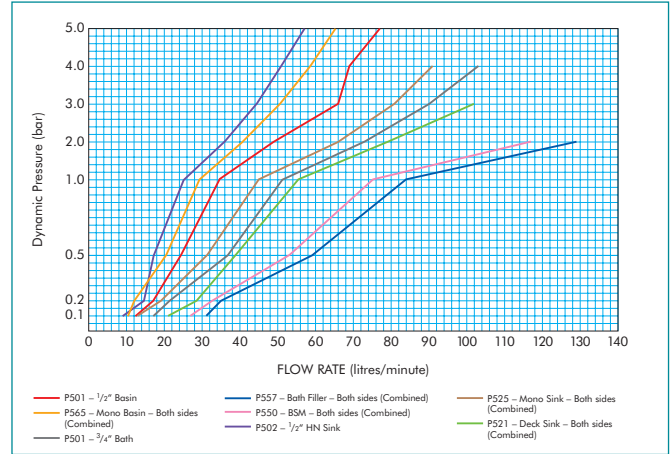

KITCHEN TAPS & MIXERS



P502 1/2" HIGH NECK PILLAR SINK TAPS

FINISH
CHROME

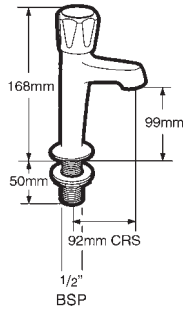

ORDER CODE
435019

- Recommended working temperature 65°C maximum
- Uses WRAS approved materials
- Minimum working pressure on washered valves 0.1 bar (Dynamic)
- Maximum working pressure on washered valves 10 bar (Static)
- Endurance tested to minimum of 200,000 cycles



P521 SINK MIXER (DUALFLOW) WITH CAST SPOUT

FINISH
CHROME

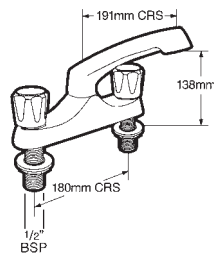

ORDER CODE
436001



P525 MONOBLOC SINK MIXER (DUALFLOW) WITH CAST SPOUT

FINISH
CHROME

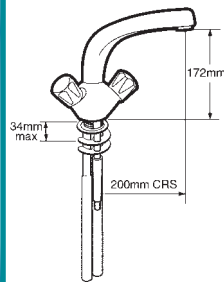

ORDER CODE
438002

PERFORMA CROSS TOP BATHROOM & KITCHEN TAPS & MIXERS

- Compression type washered valves
- Designed in accordance to either BS 5412 or BS 1010
- Smooth, modern styling
- Bold colour makings for easy identification
- Kitchen and bathroom offerings
- Low pressure operation
- Kitemark approved products



BATHROOM TAPS & MIXERS

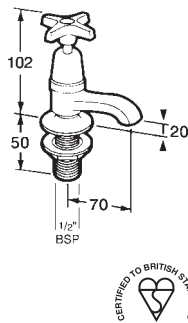

2159 1/2" BASIN TAPS BS5412

FINISH		ORDER CODE
CHROME HOT	SINGLE	H 301007
CHROME COLD	SINGLE	C 301017

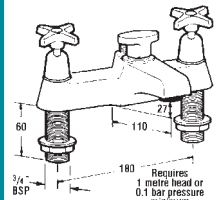

2550 DECK BATH/SHOWER MIXER BS5412
(LESS KIT) (SEE PAGE 12 FOR SHOWER KITS)

FINISH		ORDER CODE
CHROME		329100

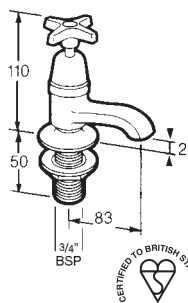

2159 3/4" BATH TAPS BS5412

FINISH		ORDER CODE
CHROME HOT	SINGLE	H 302008
CHROME COLD	SINGLE	C 302018

KITCHEN TAPS & MIXERS

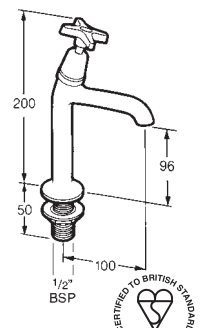

2158 1/2" HIGH NECK SINK TAPS BS5412

FINISH		ORDER CODE
CHROME HOT	SINGLE	H 303007
CHROME COLD	SINGLE	C 303017

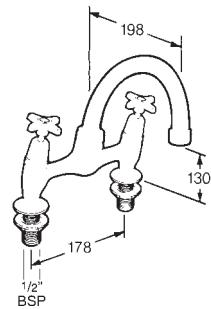

2523 PILLAR PATTERN SINK MIXER (DUALFLOW) BS5412

FINISH
CHROME

ORDER CODE
320007

BATHROOM TAPS

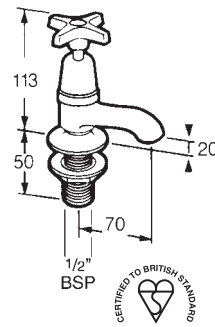

159 1/2" BASIN TAPS BS1010

FINISH

CHROME HOT
CHROME COLD

ORDER CODE
SINGLE H 304007
SINGLE C 304017

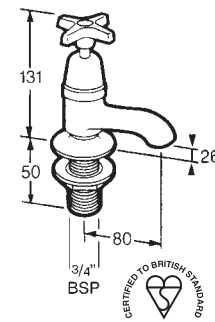

159 3/4" BATH TAPS BS1010

FINISH

CHROME HOT
CHROME COLD

ORDER CODE
SINGLE H 305008
SINGLE C 305018

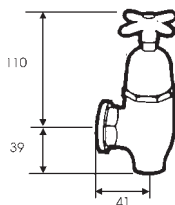

760 3/4" GLOBE PATTERN BATH TAPS - BS1010
(FOR FLOW CHART SEE PAGE 18)

FINISH

CHROME HOT
CHROME COLD

ORDER CODE
SINGLE H 323008
SINGLE C 323018

KITCHEN TAPS

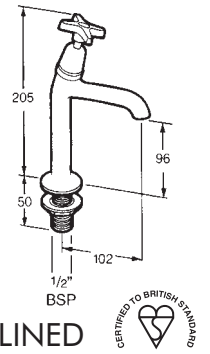

159HN INC 1/2" HIGH NECK INCLINED SINK TAPS BS1010

FINISH

CHROME
CHROME HOT
CHROME COLD

ORDER CODE

1 PAIR 306040
SINGLE H 306007
SINGLE C 306017

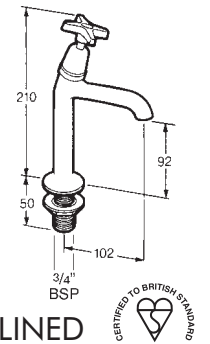

159HN INC 3/4" HIGH NECK INCLINED SINK TAPS BS1010

FINISH

CHROME HOT
CHROME COLD

ORDER CODE

SINGLE H 307008
SINGLE C 307018

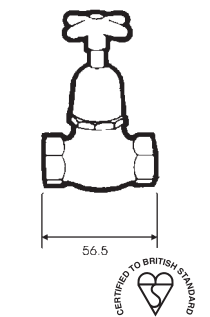

744F ECCP 1/2" STOP VALVE F x F - BS1010

FINISH

CHROME COLD

ORDER CODE

SINGLE C 312017

CROSS TOP BIBTAPS

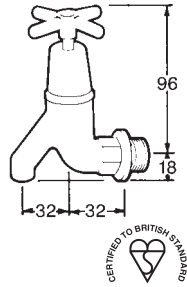

141EC 1/2" BIB TAPS - BS1010

FINISH

CHROME HOT
CHROME COLD

ORDER CODE

SINGLE H 311007
SINGLE C 311017

CROSS TOP BATHROOM AND KITCHEN TAPS AND MIXERS FLOW CHARTS

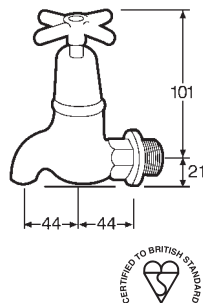
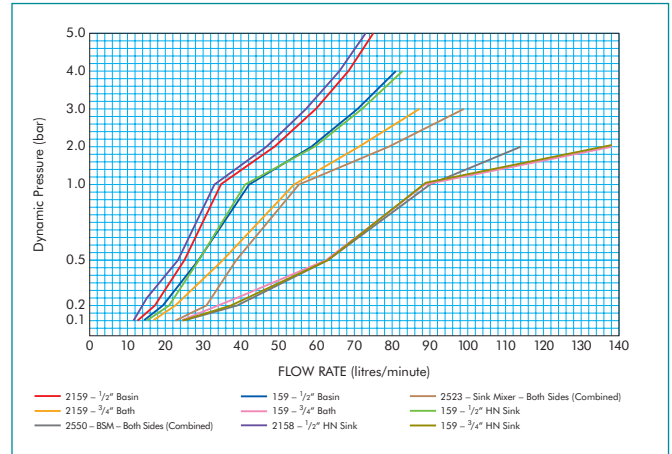

141EC 3/4" BIB TAPS - BS1010

FINISH

CHROME HOT
CHROME COLD

ORDER CODE

SINGLE H 311028
SINGLE C 311038

CROSS TOP BIB TAPS AND GLOBE PATTERN BIB TAP FLOW CHARTS*

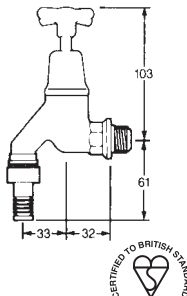
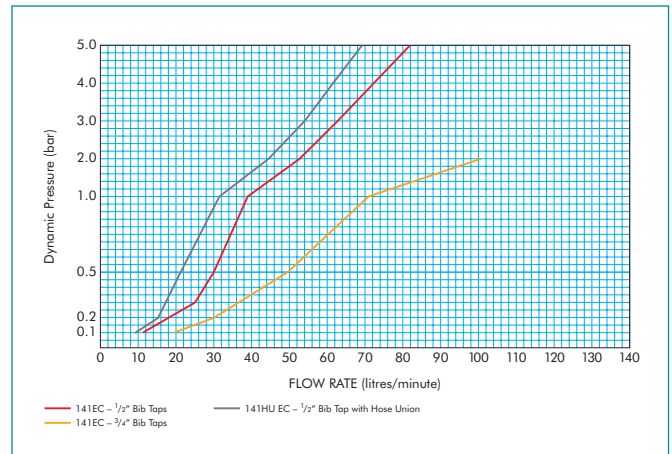

141HU EC 1/2" BIBTAPS WITH HOSE UNION - BS1010

FINISH

CHROME HOT
CHROME COLD

ORDER CODE

SINGLE H 311047
SINGLE C 311057

- Recommended working temperature 65°C Maximum
- Uses WRAS approved materials
- Minimum working pressure on washered valves 0.1 bar (Dynamic)
- Maximum working pressure on washered valves 10 bar (Static)
- Endurance tested to minimum of 200,000 cycles

PERFORMA LEVER HANDLE BATHROOM & KITCHEN TAPS & MIXERS

- Quarter turn ceramic disc technology
- Choice of lever handle styles and lengths
- Ergonomically designed handles for easy operation
- Bold colour markings for easy identification
- Both kitchen and bathroom offerings



QUARTER TURN LEVER HANDLE BATHROOM TAPS & MIXERS

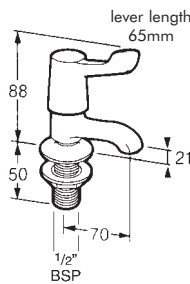

2159QT 1/2" BASIN TAPS

FINISH	ORDER CODE
CHROME HOT	SINGLE H 308027
CHROME COLD	SINGLE C 308037

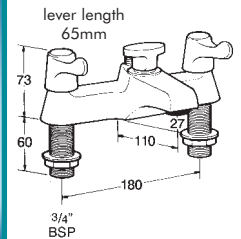

2550QT DECK BATH/SHOWER MIXER (LESS KIT)
(SEE PAGE 12 FOR SHOWER KITS)

FINISH	ORDER CODE
CHROME	329017

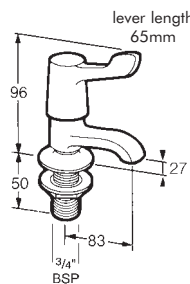

2159QT 3/4" BATH TAPS

FINISH	ORDER CODE
CHROME HOT	SINGLE H 309028
CHROME COLD	SINGLE C 309038

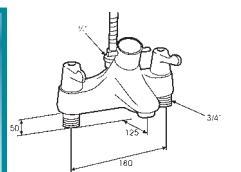

555 THERMOSTATIC BATH/SHOWER MIXER
(LESS KIT) (SEE PAGE 12 FOR SHOWER KITS)

FINISH	ORDER CODE
CHROME	431004

QUARTER TURN LEVER HANDLE KITCHEN TAPS & MIXERS

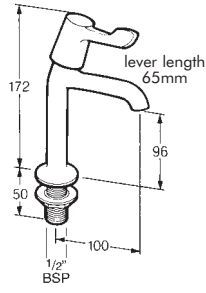

2158QT 1/2" HIGH NECK SINK TAPS

FINISH	ORDER CODE
CHROME	1 PAIR 310040
CHROME HOT	SINGLE H 310027
CHROME COLD	SINGLE C 310037

QUARTER TURN SNUB LEVER BATHROOM TAPS & MIXERS

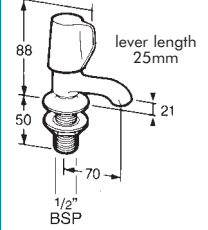

2159QTSL SNUB LEVER 1/2" BASIN TAPS

FINISH	ORDER CODE
CHROME	1 PAIR 324067
CHROME HOT	H 324047
CHROME COLD	C 324057

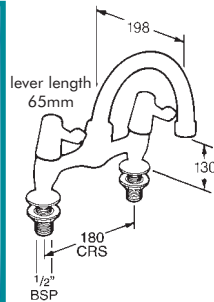

2523QT PILLAR PATTERN SINK
MIXER (DUALFLOW)

FINISH	ORDER CODE
CHROME	320027

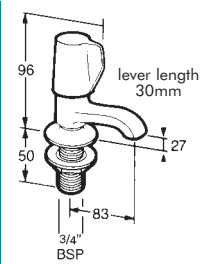

2159QTSL SNUB LEVER 3/4" BATH TAPS

FINISH	ORDER CODE
CHROME	1 PAIR 325067
CHROME HOT	SINGLE H 325047
CHROME COLD	SINGLE C 325057

QUARTER TURN SNUB LEVER KITCHEN TAPS & MIXERS

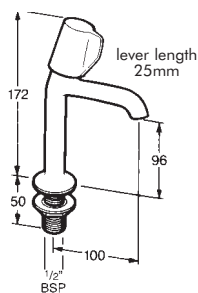

2158QTSL SNUB LEVER 1/2"
HIGH NECK SINK TAPS

FINISH	ORDER CODE
CHROME	1 PAIR 326047
CHROME HOT	SINGLE H 326027
CHROME COLD	SINGLE C 326037

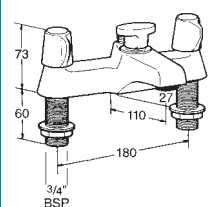

2550QTSL SNUB LEVER DECK BATH/SHOWER
MIXER (LESS KIT) (SEE PAGE 12 FOR SHOWER KITS)

FINISH	ORDER CODE
CHROME	328020

555QT Operating Requirements

min inlet pressure:	0.1 bar dynamic
max inlet pressure:	6.0 bar dynamic
max pressure loss ratio:	5:1
max temperature of incoming hot water:	65°C

Performance Characteristics

maintains water temperature within 2°C.
designed in accordance with BS5412, BS1111 and BS1287.
chrome plated to comply with BS1224

QUARTER TURN EXTENDED LEVER HANDLE BATHROOM TAPS

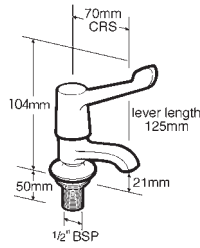

2159QTEL EXTENDED LEVER 1/2" BASIN TAPS

FINISH	ORDER CODE
CHROME	1 PAIR 330023
CHROME HOT	SINGLE H 330021
CHROME COLD	SINGLE C 330022

QUARTER TURN EXTENDED LEVER HANDLE KITCHEN TAPS & MIXERS

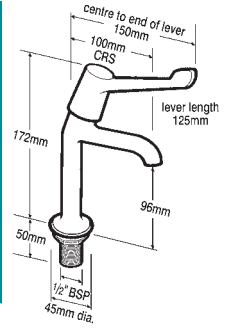

2158QTEL EXTENDED LEVER 1/2" HIGH NECK SINK TAPS

FINISH	ORDER CODE
CHROME	1 PAIR 333023
CHROME HOT	SINGLE H 333021
CHROME COLD	SINGLE C 333022

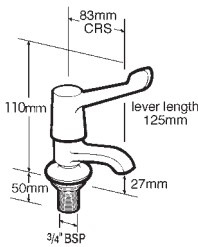

2159QTEL EXTENDED LEVER 3/4" BATH TAPS

FINISH	ORDER CODE
CHROME	1 PAIR 330026
CHROME HOT	SINGLE H 330024
CHROME COLD	SINGLE C 330025

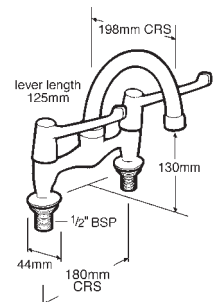

2523QTEL EXTENDED LEVER PILLAR PATTERN SINK MIXER (DUALFLOW)

FINISH	ORDER CODE
CHROME	337011

LEVER HANDLE BATHROOM AND KITCHEN TAPS AND MIXERS FLOW CHARTS

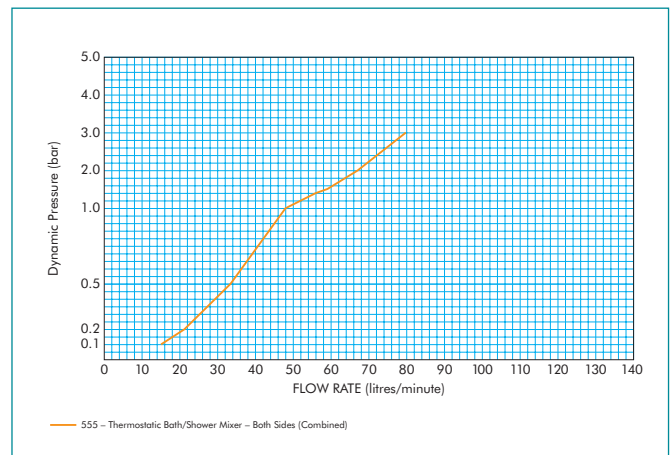
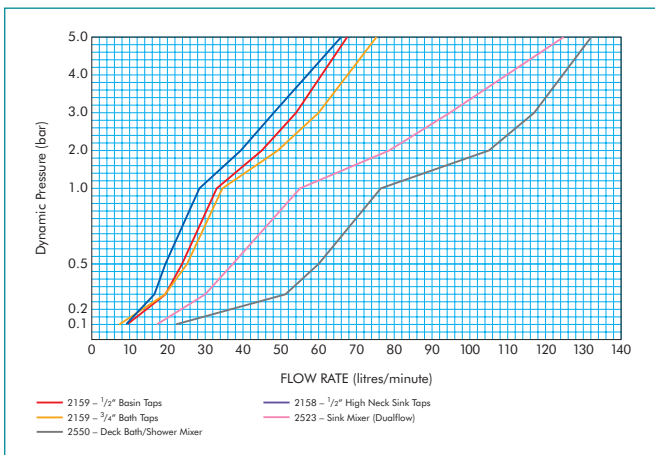

- Recommended working temperature 65°C maximum
- Uses WRAS approved materials
- Minimum working pressure on ceramic disc cartridges 0.1 bar (Dynamic)
- Maximum working pressure on ceramic disc cartridges 6.0 bar (Static)
- Endurance tested to minimum of 200,000 cycles

PERFORMA

HEALTHCARE TAPS AND MIXERS

THE PERFORMA RANGE OF HEALTHCARE TAPS AND MIXERS

In the dynamic area of healthcare it is important to have products that work reliably. A tap that malfunctions causes unnecessary problems for staff and patients alike.

Pegler is proud to present its range of products suitable for hospitals and other healthcare applications. Performa products are built to last and are easy to service, if required. Many products in the range are also available with the unique Kliniklene finish, a proven and independently tested coating which has been specially developed to combat MRSA and other hospital 'superbugs'. All Performa products are backed by full service, spares availability and a technical support team that provides a level of special care.

Pegler has, in this booklet, amalgamated its ranges to provide brassware solutions for the specialised areas in hospitals, clinics, nursing homes and doctors surgeries, including public areas, nurses' homes and staff facilities. Whether the application is heating or plumbing you will find a solution with Pegler.

Pegler products are all covered by extended warranties* which includes materials, workmanship and even finish on the proviso that fitting and care instructions are followed.

Pegler has, with its product reliability and customer care, produced a total package that reduces whole life costs of its fittings and helps you give the service patients deserve.

- Durable long lasting products.
- Easy to service and maintain.
- Reduces whole lifetime costs.

* Full details available on request.



Pegler



PERFORMA HEALTHCARE TAPS & MIXERS

Basin and kitchen taps with 150mm levers allowing elbow action. Sold singly to give ultimate flexibility. Made to Pegler's exacting standards, these products are designed to work with minimum maintenance.

- Washed fast rising spindle with quick turn action.
- Made from WRAS Approved materials.
- Conforms to the performance of BS5412.
- Pip on hot tap to aid identification.
- Chrome plate to BS 1224.
- Full spares list.



DIMENSIONS (MM)

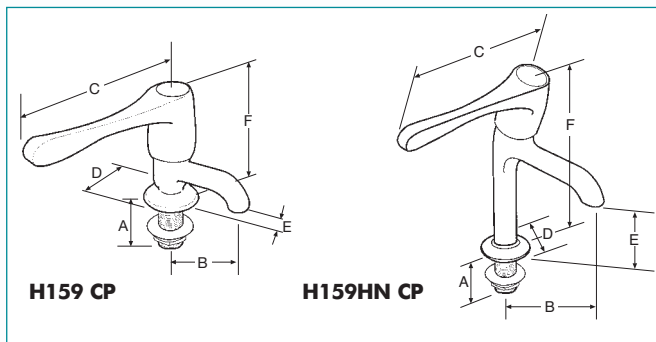

SIZES	H159 CP	H159HN CP
A	50	50
B	70 CRS	101.5 CRS
C	150	150
D	Ø44	Ø45.5
E	20	96
F	97.5	175

RANGE/ORDER CODES

PATTERN NO.	ORDER CODE
H159 CP	H 360001
H159 CP	C 360002
H159HN CP	H 360003
H159HN CP	C 360004

TECHNICAL INFORMATION

	H159 CP	H159HN CP
MATERIALS	Body BRASS Lever BRASS	Body BRASS Lever BRASS
CARTRIDGE TYPE	QUICK TURN FAST RISING SPINDLE	QUICK TURN FAST RISING SPINDLE
MAX. WORKING TEMPERATURE	65°C	65°C
OUTLET TYPE	OPEN	OPEN
CONNECTIONS	½" BSP	½" BSP
SURFACE FINISH	CHROME PLATE	CHROME PLATE
RECOMMENDED OPERATING PRESSURES	MIN. 0.1 BAR MAX. 10 BAR	MIN. 0.1 BAR MAX. 10 BAR
MAX. THICKNESS OF WARE/WORKTOP	45MM	45MM

FLOW RATES (LITRES/MINUTE)

PRESSURE (BAR)	H159 CP	H159HN CP
0.1	12.0	13.2
0.5	31.8	34.8
1.0	39.0	44.4
5.0	81.0	84.0

FLOW CHART

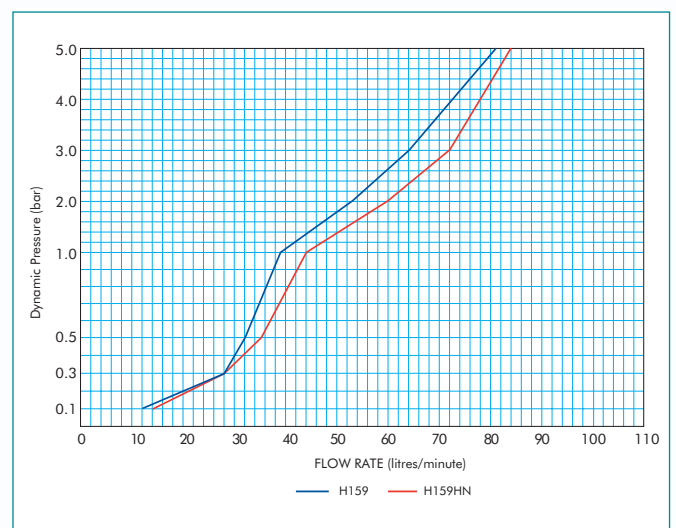

PERFORMA HEALTHCARE TAPS & MIXERS

The ingenious Peglerspray is a lever operated monobloc mixer ideal for handrinse applications.

- Supplied with alternative flow straightener for basin-filling.
- Complete temperature range control: through an arc of 125°, preventing a sudden surge of hot water.
- Mechanical temperature limiter allows a pre-determined maximum temperature to be set, greatly reducing the risk of scalding.
- Chrome plate finish to BS 1224.
- Ideal for applications where economy, flexibility and user safety are high priorities.
- Water-saving and user safety features.
- Flow regulator for on site adjustment.



DIMENSIONS (MM)

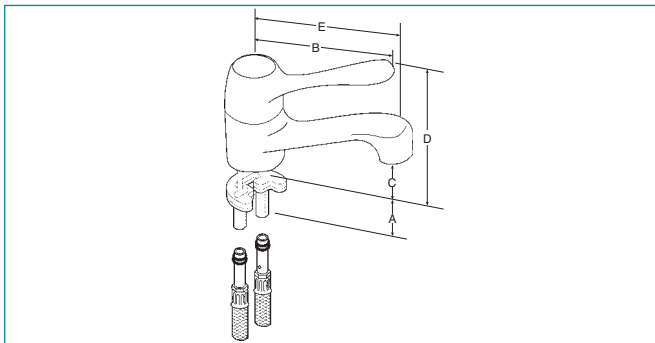

SIZES	H401
A	38
B	104
C	50.5
D	122
E	117

RANGE/ORDER CODES

PATTERN NO.	ORDER CODE
H401	360021

FLOW RATES (LITRES/MINUTE)

PRESSURE (BAR)	H401	
	SPRAY WITH REGULATOR	FLOW STRAIGHTENER
0.1	0.95	1.85
0.5	2.0	4.2
1.0	2.4	6.0
5.0	3.5	12.3

TECHNICAL INFORMATION

MATERIALS	Body BRASS Spray Outlet PLASTIC/BRASS Headwork BRASS Lever BRASS
CARTRIDGE TYPE	SEQUENTIAL MIX FROM OFF THROUGH COLD TO HOT IN 125° ARC OF MOVEMENT (WHEN LIMIT STOP NOT USED).
MAX. WORKING TEMPERATURE	80°C
MAX. OUTLET TEMPERATURE SETTING	BRASS PLATE LOCATED ON SPINDLE. ADJUSTABLE TO SUIT SYSTEM INLET TEMPERATURES AND USER REQUIREMENTS. STABLE OUTLET TEMPERATURES ARE DEPENDANT ON PRESSURE AND TEMPERATURE SUPPLY BEING CONSTANT.
OUTLET TYPE	SPRAY OUTLET FITTED WHICH INCORPORATES INTERCHANGEABLE FLOW STRAIGHTENER SUPPLIED LOOSE IN BOX FOR BASIN FILLING.
CONNECTIONS	FLEXIBLE TAIL ½" BSP X 10"
INLET SHANK	¾" BSP (26.4MM OD)
SURFACE FINISH	CHROME PLATE
RECOMMENDED OPERATING PRESSURES	MIN. 0.2 BAR MAX. 10 BAR IT IS RECOMMENDED THAT PRESSURES BE BALANCED. FLOW STRAIGHTENER REQUIRES 0.5 BAR PRESSURE.
MAX. THICKNESS OF WARE/WORKTOP	38MM

FLOW CHART

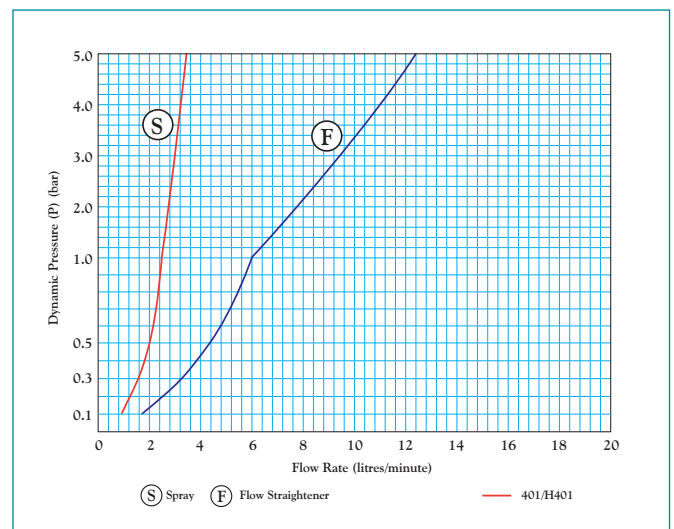

PERFORMA HEALTHCARE TAPS & MIXERS

Aesthetically smooth design with robust levers which overhang the body preventing dirt and bacteria. Body raised to allow cleaning beneath the mixer. 1/2" pillar mixer with 150mm levers and swivel nozzle.

- Washered fast rising spindle with quick turn action.
- Available with dual flow or healthcare laminated flow with integral flow regulator.
- Pip in hot tap to aid identification.
- Made from approved materials.
- Mounting flange has two flats to aid minor adjustment.
- Conforms to the performance of BS 5412.



DIMENSIONS (MM)

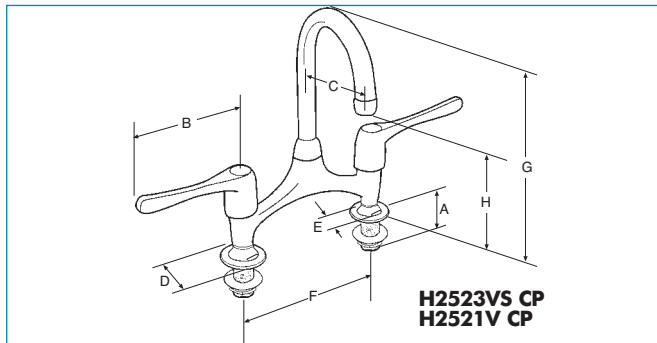

SIZES	H2523VS CP	H2523V CP
A	50	50
B	150	150
C	125 CRS	125 CRS
D	Ø57	Ø57
E	28 A/F	28 A/F
F	200 CRS	200 CRS
G	326.5	326.5
H	226.5	226.5

RANGE/ORDER CODES

PATTERN NO.	ORDER CODE
H2523V CP	360022
H2523VS CP	360023

TECHNICAL INFORMATION

	H2523VS CP	H2523V CP
MATERIALS	Body BRASS Lever BRASS Spout BRASS	Body BRASS Lever BRASS Spout BRASS
CARTRIDGE TYPE	QUICK TURN FAST RISING SPINDLE	QUICK TURN FAST RISING SPINDLE
MAX. WORKING TEMPERATURE	65°C	65°C
OUTLET TYPE	LAMINATED FLOW	DUAL FLOW
CONNECTIONS	1/2" BSP	1/2" BSP
SURFACE FINISH	CHROME PLATE	CHROME PLATE
RECOMMENDED OPERATING PRESSURES	MIN. 0.1 BAR MAX. 10 BAR	MIN. 0.1 BAR MAX. 10 BAR
MAX. THICKNESS OF WARE/WORKTOP	45MM	45MM

FLOW RATES (LITRES/MINUTE)

PRESSURE (BAR)	H2523VS CP LAMINATED FLOW	H2523V CP EQUAL MIX
0.1	8.0	9.9
0.5	8.0	22.8
1.0	8.0	30.6
5.0	8.0	64.2

FLOW CHART

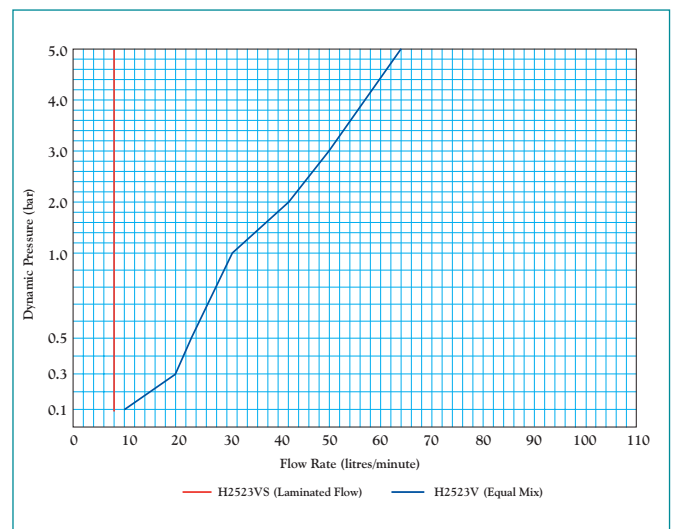

PERFORMA HEALTHCARE TAPS & MIXERS

A range of concealed fittings mixers, designed to give you versatility when specifying or even after fitting. The dual flow and single flow use the mixer body which can come with or without integrated flow reduction/isolating valves. These can be refitted later, if required.

- Conforms to the performance of BS 5412.
- In-built flow reduction valves for volume control and isolation during servicing.
- Washered fast rising spindle for long life.
- Mounting has two flats to aid minor adjustment.
- Healthcare laminated flow with built-in flow regulator.
- Horizontal or vertical spout versions available.
- Pip on hot tap to aid identification.



DIMENSIONS (MM)

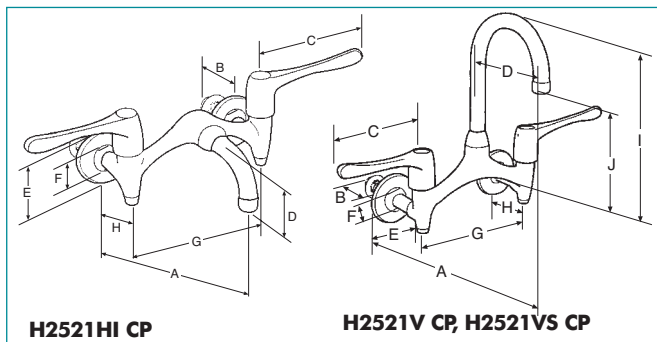

SIZES	H2521HI CP	H2521V/VS CP
A	200	200
B	50	50
C	150	150
D	48.5	125 CRS
E	Ø77	Ø77
F	28 A/F	28 A/F
G	200 CRS	200 CRS
H	75	75
I	-	300
J	-	277.5

RANGE/ORDER CODES

PATTERN NO.	ORDER CODE
H2521V CP	360024
H2521VS CP	360025
H2521HI CP	360029

TECHNICAL INFORMATION

	H2521HI CP, H2521V CP	H2521VS CP
MATERIALS	Body BRASS Lever BRASS Spout BRASS	Body BRASS Lever BRASS Spout BRASS
CARTRIDGE TYPE	QUICK TURN FAST RISING SPINDLE	QUICK TURN FAST RISING SPINDLE
MAX. WORKING TEMPERATURE	65°C	65°C
OUTLET TYPE	DUAL FLOW	LAMINATED FLOW
CONNECTIONS	½" BSP	½" BSP
SURFACE FINISH	CHROME PLATE	CHROME PLATE
RECOMMENDED OPERATING PRESSURES	MIN. 0.1 BAR MAX. 10 BAR	MIN. 0.1 BAR MAX. 10 BAR
MAX. THICKNESS OF WALL	45MM	45MM

FLOW RATES (LITRES/MINUTE)

PRESSURE (BAR)	H2521HI	H2521V	H2521VS
	EQUAL MIX	EQUAL MIX	LAMINATED FLOW
0.1	8.1	9.0	8.0
0.5	19.4	23.4	8.0
1.0	25.9	30.6	8.0
5.0	56.1	63.9	8.0

FLOW CHART

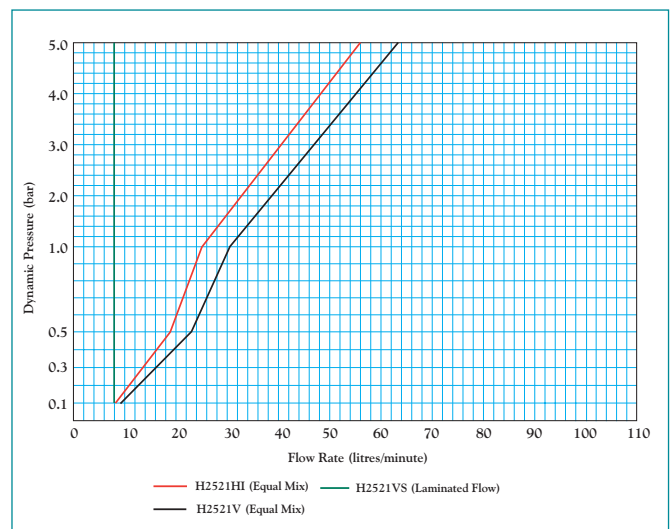

Basin and kitchen taps with 150mm levers allowing elbow action. Sold singly to give ultimate flexibility. Made to Pegler's exacting standards, these products are designed to work with minimum maintenance.

- Washed fast rising spindle with quickturn action.
- Made from WRAS Approved materials.
- Conforms to the performance of BS5412.
- Pip on hot tap to aid identification.
- Chrome plate to BS 1224.
- Full spares list.



BASIN TAP

SINK TAP

DIMENSIONS (MM)

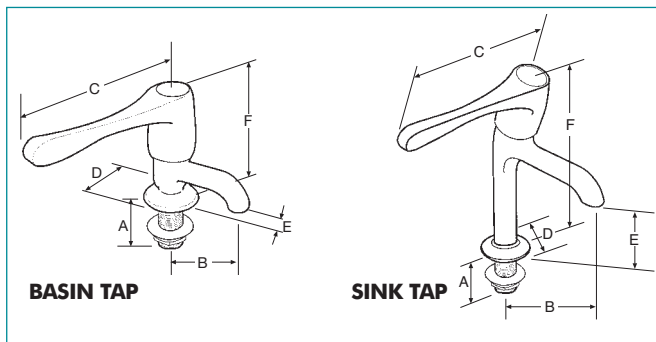

SIZES	BASIN TAP	SINK TAP
A	50	50
B	70 CRS	101.5 CRS
C	150	150
D	Ø44	Ø45.5
E	20	96
F	97.5	175

RANGE/ORDER CODES

PATTERN NO.	ORDER CODE
BASIN TAP	H 361001
BASIN TAP	C 361002
SINK TAP	H 361003
SINK TAP	C 361004

TECHNICAL INFORMATION

	BASIN TAP	SINK TAP
MATERIALS	Body BRASS Lever BRASS	Body BRASS Lever BRASS
CARTRIDGE TYPE	QUICK TURN FAST RISING SPINDLE	QUICK TURN FAST RISING SPINDLE
MAX. WORKING TEMPERATURE	65°C	65°C
OUTLET TYPE	OPEN	OPEN
CONNECTIONS	½" BSP	½" BSP
SURFACE FINISH	KLINIKLENE CHROME PLATE	KLINIKLENE CHROME PLATE
RECOMMENDED OPERATING PRESSURES	MIN. 0.1 BAR MAX. 10 BAR	MIN. 0.1 BAR MAX. 10 BAR
MAX. THICKNESS OF WARE/WORKTOP	45MM	45MM

FLOW RATES (LITRES/MINUTE)

PRESSURE (BAR)	BASIN TAP	SINK TAP
0.1	12.0	13.2
0.5	31.8	34.8
1.0	39.0	44.4
5.0	81.0	84.0

FLOW CHART

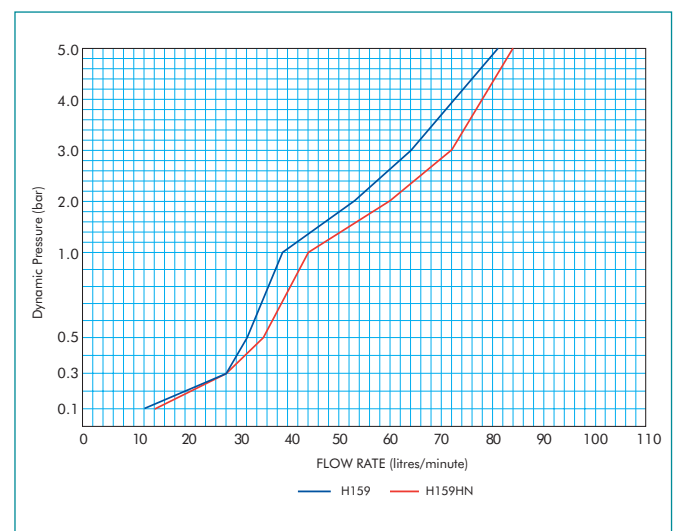

A range of wall mounted bibtaps packaged singly for maximum flexibility. The H141EX allows extensions from the wall. A range of extensions for block walls are available from Pegler on request.

- Washered fast rising spindle with quick turn action for long life.
- Laminated Healthcare Flow.
- Flow limited to 8 litres/minute.
- Extended shank version.
- Pip on hot tap to aid identification.



DIMENSIONS (MM)

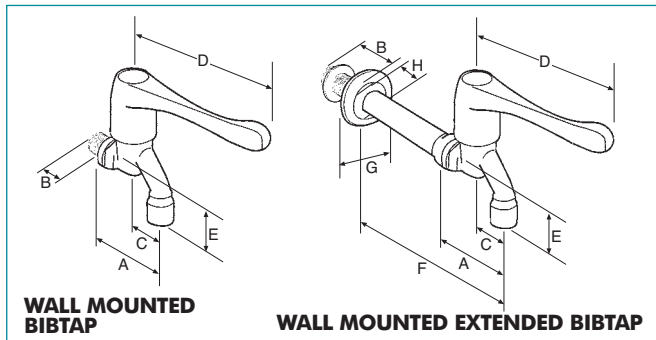

SIZES	BIBTAP	EXTENDED BIBTAP
A	65	65
B	12.7	12.7
C	33.5	33.5
D	150	150
E	37	37
F	-	200
G	-	Ø57
H	-	28 A/F

RANGE/ORDER CODES

PATTERN NO.	ORDER CODE
BIBTAP	H 361005
BIBTAP	C 361006
EXTENDED BIBTAP	H 361007
EXTENDED BIBTAP	C 361008

TECHNICAL INFORMATION

	BIBTAP	EXTENDED BIBTAP
MATERIALS	Body BRASS Lever BRASS	Body BRASS Lever BRASS
CARTRIDGE TYPE	QUICK TURN FAST RISING SPINDLE	QUICK TURN FAST RISING SPINDLE
MAX. WORKING TEMPERATURE	65°C	65°C
OUTLET TYPE	LAMINATED FLOW	LAMINATED FLOW
CONNECTIONS	1/2" BSP	1/2" BSP
SURFACE FINISH	KLINIKLENE CHROME PLATE	KLINIKLENE CHROME PLATE
RECOMMENDED OPERATING PRESSURES	MIN. 0.1 BAR MAX. 10 BAR	MIN. 0.1 BAR MAX. 10 BAR
MAX. THICKNESS OF WALL	A VARIETY OF EXTENSIONS ARE AVAILABLE ON REQUEST	A VARIETY OF EXTENSIONS ARE AVAILABLE ON REQUEST

FLOW RATES (LITRES/MINUTE)

PRESSURE (BAR)	BIBTAP	EXTENDED BIBTAP
0.1	8.0	8.0
0.5	8.0	8.0
1.0	8.0	8.0
5.0	8.0	8.0

FLOW CHART

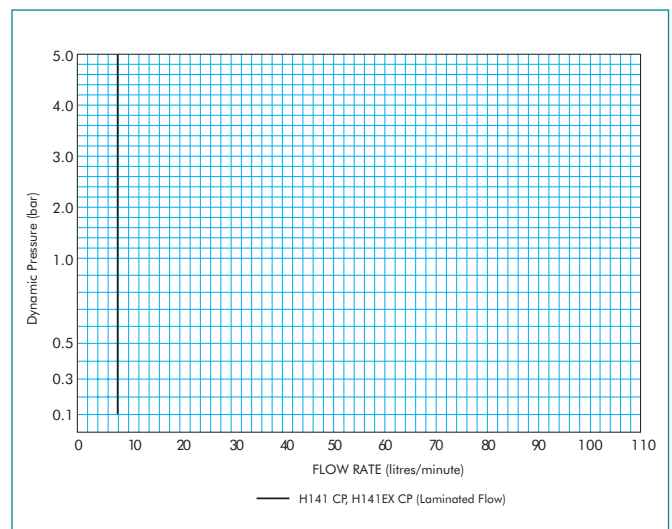

The ingenious Peglerspray is a lever operated monobloc mixer ideal for handrinse applications.

- Supplied with alternative flow straightener for basin-filling.
- Complete temperature range control: through an arc of 125°, preventing a sudden surge of hot water.
- Mechanical temperature limiter allows a pre-determined maximum temperature to be set, greatly reducing the risk of scalding.
- Chrome plate finish to BS 1224.
- Ideal for applications where economy, flexibility and user safety are high priorities.
- Water-saving and user safety features.
- Flow regulator for on site adjustment.



DIMENSIONS (MM)

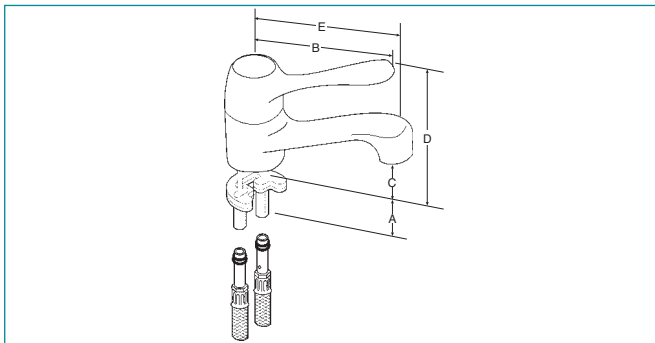

SIZES	MONOBLOC BASIN MIXER
A	38
B	104
C	50.5
D	122
E	117

RANGE/ORDER CODES

PATTERN NO.	ORDER CODE
MONOBLOC BASIN MIXER	361021

FLOW RATES (LITRES/MINUTE)

PRESSURE (BAR)	MONOBLOC BASIN MIXER	
	SPRAY WITH REGULATOR	EQUAL MIX
0.1	0.95	1.85
0.5	2.0	4.2
1.0	2.4	6.0
5.0	3.5	12.3

TECHNICAL INFORMATION

MATERIALS	Body BRASS Spray Outlet PLASTIC/BRASS Headwork BRASS Lever BRASS
CARTRIDGE TYPE	SEQUENTIAL MIX FROM OFF THROUGH COLD TO HOT IN 125° ARC OF MOVEMENT (WHEN LIMIT STOP NOT USED).
MAX. WORKING TEMPERATURE	80°C
MAX. OUTLET TEMPERATURE SETTING	BRASS PLATE LOCATED ON SPINDLE. ADJUSTABLE TO SUIT SYSTEM INLET TEMPERATURES AND USER REQUIREMENTS. STABLE OUTLET TEMPERATURES ARE DEPENDANT ON PRESSURE AND TEMPERATURE SUPPLY BEING CONSTANT.
OUTLET TYPE	SPRAY OUTLET FITTED. INTERCHANGEABLE FLOW STRAIGHTENER SUPPLIED LOOSE IN BOX FOR BASIN FILLING.
CONNECTIONS	H401 FLEXIBLE TAIL ½" BSP X 10"
INLET SHANK	¾" BSP (26.4MM OD)
SURFACE FINISH	KLINIKLENE CHROME PLATE
RECOMMENDED OPERATING PRESSURES	MIN. 0.2 BAR MAX. 10 BAR IT IS RECOMMENDED THAT PRESSURES BE BALANCED. FLOW STRAIGHTENER REQUIRES 0.5 BAR PRESSURE.
MAX. THICKNESS OF WARE/WORKTOP	38MM

FLOW CHART

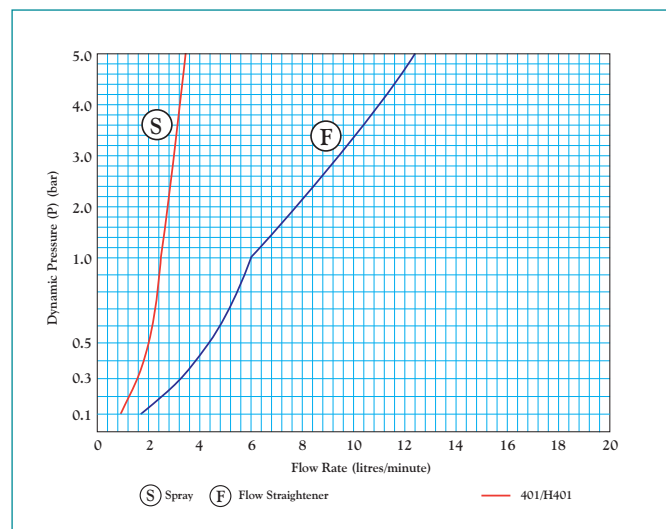

Aesthetically smooth design with robust levers which overhang the body preventing dirt and bacteria. Body raised to allow cleaning beneath the mixer. 1/2" pillar mixer with 150mm levers and swivel nozzle.

- Washed fast rising spindle with quick turn action.
- Available with dual flow or healthcare laminated flow with integral flow regulator.
- Pip in hot tap to aid identification.
- Made from approved materials.
- Mounting flange has two flats to aid minor adjustment.
- Conforms to the performance of BS 5412.



DIMENSIONS (MM)

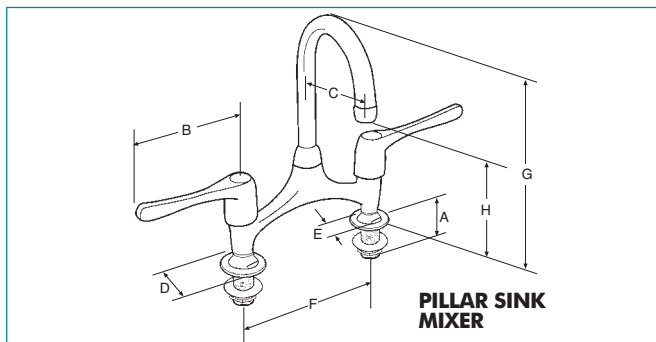

SIZES	SINGLE FLOW	DUAL FLOW
A	50	50
B	150	150
C	125 CRS	125 CRS
D	Ø57	Ø57
E	28 A/F	28 A/F
F	200 CRS	200 CRS
G	326.5	326.5
H	226.5	226.5

RANGE/ORDER CODES

PATTERN NO.	ORDER CODE
DUAL FLOW	361022
SINGLE FLOW	361023

TECHNICAL INFORMATION

	SINGLE FLOW	DUAL FLOW
MATERIALS	Body BRASS Lever BRASS Spout BRASS	Body BRASS Lever BRASS Spout BRASS
CARTRIDGE TYPE	QUICK TURN FAST RISING SPINDLE	QUICK TURN FAST RISING SPINDLE
MAX. WORKING TEMPERATURE	65°C	65°C
OUTLET TYPE	LAMINATED FLOW	DUAL FLOW
CONNECTIONS	1/2" BSP	1/2" BSP
SURFACE FINISH	KLINIKLENE CHROME PLATE	KLINIKLENE CHROME PLATE
RECOMMENDED OPERATING PRESSURES	MIN. 0.1 BAR MAX. 10 BAR	MIN. 0.1 BAR MAX. 10 BAR
MAX. THICKNESS OF WARE/WORKTOP	45MM	45MM

FLOW RATES (LITRES/MINUTE)

PRESSURE (BAR)	SINGLE FLOW LAMINATED FLOW	DUAL FLOW EQUAL MIX
0.1	8.0	9.9
0.5	8.0	22.8
1.0	8.0	30.6
5.0	8.0	64.2

FLOW CHART

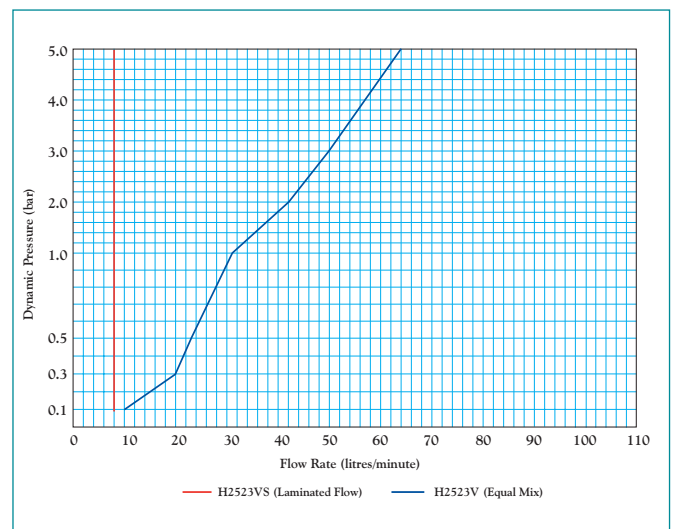

A range of concealed fittings mixers, designed to give you versatility when specifying or even after fitting. The dual flow and single flow use the mixer body which can come with or without integrated flow reduction/isolating valves. These can be refitted later, if required.

- Conforms to the performance of BS 5412.
- In-built flow reduction valves for volume control and isolation during servicing.
- Washered fast rising spindle for long life.
- Mounting has two flats to aid minor adjustment.
- Healthcare laminated flow with built-in flow regulator.
- Horizontal or vertical spout versions available.
- Pip on hot tap to aid identification.



DIMENSIONS (MM)

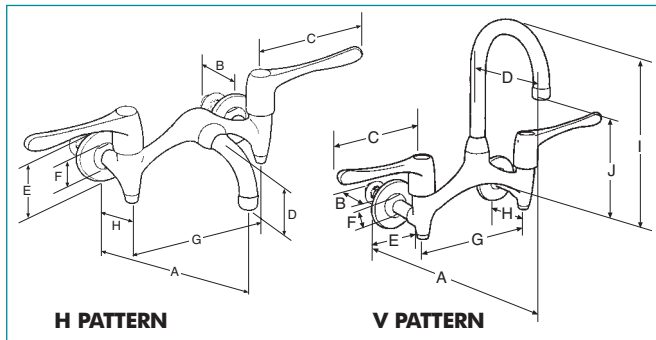

SIZES	H PATTERN	V PATTERN
A	200	200
B	50	50
C	150	150
D	48.5	125 CRS
E	Ø77	Ø77
F	28 A/F	28 A/F
G	200 CRS	200 CRS
H	75	75
I	-	300
J	-	277.5

RANGE/ORDER CODES

PATTERN NO.	ORDER CODE
DUAL FLOW	361024
SINGLE FLOW	361025
DUAL FLOW	361026 EXPOSED INLETS. ISOLATING VALVES
DUAL FLOW	361027
SINGLE FLOW	361028 EXPOSED INLETS
DUAL FLOW	361029 ISOLATING VALVE
DUAL FLOW	361030 ISOLATING VALVE

TECHNICAL INFORMATION

	H PATTERN	V PATTERN
MATERIALS	Body BRASS Lever BRASS Spout BRASS	Body BRASS Lever BRASS Spout BRASS
CARTRIDGE TYPE	QUICK TURN FAST RISING SPINDLE	QUICK TURN FAST RISING SPINDLE
MAX. WORKING TEMPERATURE	65°C	65°C
OUTLET TYPE	DUAL FLOW	LAMINATED FLOW
CONNECTIONS	½" BSP	½" BSP
SURFACE FINISH	KLINIKLENE CHROME PLATE	KLINIKLENE CHROME PLATE
RECOMMENDED OPERATING PRESSURES	MIN. 0.1 BAR MAX. 10 BAR	MIN. 0.1 BAR MAX. 10 BAR
MAX. THICKNESS OF WALL	45MM	45MM

FLOW RATES (LITRES/MINUTE)

PRESSURE (BAR)	361027	361029	361024	361025	361028	361026	361030
	EQUAL MIX	EQUAL MIX	EQUAL MIX	EQUAL MIX	EQUAL MIX	LAMINATED FLOW	LAMINATED FLOW
0.1	8.1	8.1	9.0	9.0	9.9	8.0	8.0
0.5	21.6	19.4	23.4	21.6	22.8	8.0	8.0
1.0	27.5	25.9	30.6	28.8	30.6	8.0	8.0
5.0	57.5	56.1	63.9	62.4	64.2	8.0	8.0

FLOW CHART

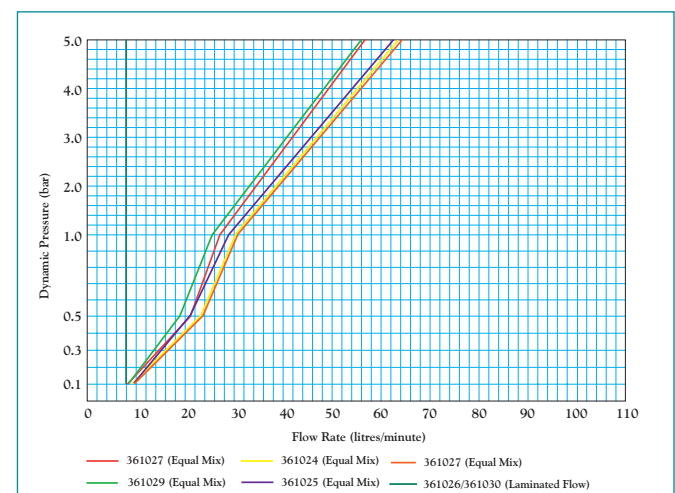

PERFORMA



WATER SAVING FLOW CONTROLS

THE PERFORMA RANGE OF WATER SAVING DEVICES

Water is one of the world's most vital resources – a precious and increasingly costly commodity.

Which is why Performa water saving flow controls are now being used in a diverse and ever-growing number of applications.

- Robust, vandal-resistant construction.
- Significant reductions in water bills.
- Engineered for reliability and durability.
- BS EN ISO 9002 accreditation.
- Extensive water-saving range includes manual and electronic self-closing taps for basins; self-closing showers; automatic urinal-flushing devices; in-line thermostatic mixing valves; and products designed specifically for users with restricted hand movement.
- Suitable for a wide variety of applications where saving water is a priority – from campsites and prisons to motorway service washrooms and hospitals.
- Every product comes complete with Pegler's watertight guarantee of quality.



Pegler

PERFORMA ECO

BASIN TAPS

- Every basin tap fitted with a flow regulator to reduce water wastage to max 4 litres per min (+ or - 15%).
- Robust construction.
- Significant reductions in water usage – long term cost savings.
- Engineered for reliability and durability.
- Suitable for a wide variety of applications where saving water is a priority – schools, washrooms, offices and more.

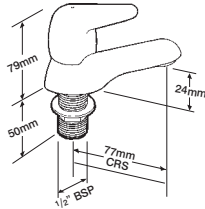

LEGER 1/2" BASIN TAPS

FINISH
CHROME (PAIR)

ORDER CODE
4B7040

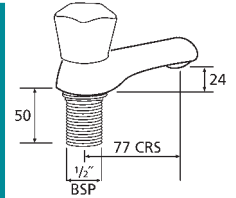

DANUM 1/2" BASIN TAPS

FINISH
CHROME (PAIR)

ORDER CODE
404011

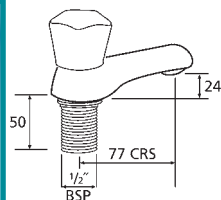

DANUM 1/2" DCD BASIN TAPS

FINISH
CHROME (PAIR)

ORDER CODE
404069

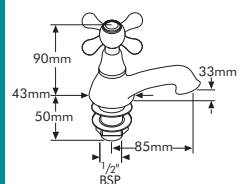

SOUVENIR 1/2" BASIN TAPS

FINISH
CHROME (PAIR)

ORDER CODE
4W9040

PERFORMA ECO

BASIN TAPS

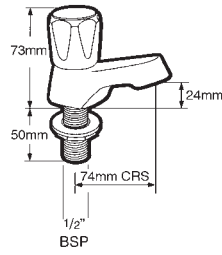

POLO 1/2" BASIN TAPS

FINISH
CHROME (PAIR)

ORDER CODE
434005

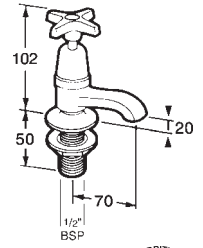

2159 1/2" BASIN TAPS BS5412

FINISH
CHROME (PAIR)

ORDER CODE
301028

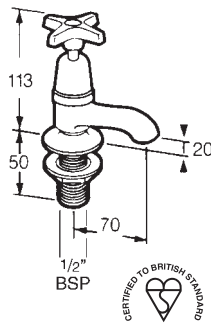

159 1/2" BASIN TAPS BS1010

FINISH
CHROME (PAIR)

ORDER CODE
304018

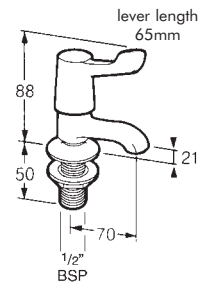

2159QT 1/2" QUARTER TURN BASIN TAPS

FINISH
CHROME (PAIR)

ORDER CODE
308048

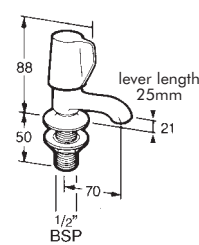

2159QTSL QUARTER TURN SNUB LEVER 1/2" BASIN TAPS

FINISH
CHROME (PAIR)

ORDER CODE
324068

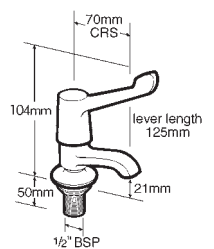

2159QTEL QUARTER TURN EXTENDED LEVER 1/2" BASIN TAPS

FINISH
CHROME (PAIR)

ORDER CODE
330030

FLOW CHART

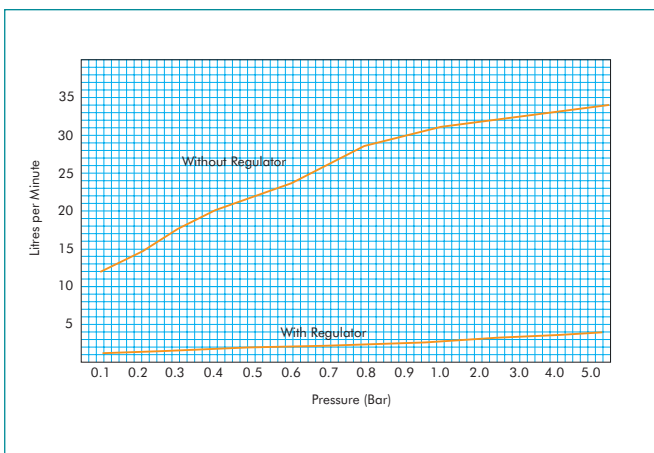

PERFORMA SELF-CLOSING BASIN TAPS



870 SELF-CLOSING BASIN TAP

Basin Pillar Tap with pre-set, non-adjustable time delay of 15 seconds. Supplied with flow straightener fitted and interchangeable anti-splash aerator for high pressure.

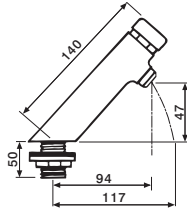

873 SELF-CLOSING BASIN TAP

Basin Pillar Tap with under basin cartridge and flow regulator situated under the handle for on site adjustment.

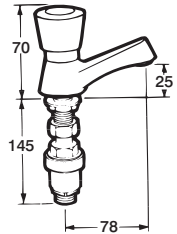

TECHNICAL INFORMATION

MATERIALS	Handle BRASS Body BRASS Cartridge PLASTIC
TIME DELAY	NON-ADJUSTABLE, 15 SECONDS IN ACCORDANCE WITH BS EN 816
MAX. WORKING TEMPERATURE	70°C
OUTLET TYPE	PLASTIC FLOW STRAIGHTENER. INTERCHANGEABLE ANTI-SPLASH AERATOR SUPPLIED LOOSE FOR USE AT PRESSURE ABOVE 1 BAR
CONNECTIONS	1/2" BSP MALE PARALLEL THREAD SUITABLE FOR TAP CONNECTOR OR 15MM CU COMPRESSION JOINT CONNECTION
SURFACE FINISH	CHROME PLATE

RANGE/ORDER CODES

PATTERN NO.	ORDER CODE
CHROME	340007

RECOMMENDED OPERATING PRESSURES

MINIMUM	0.2 BAR (2 METRES) STATIC
MAXIMUM	6 BAR

FLOW RATES (LITRES/MINUTE)

DYNAMIC PRESSURES (BAR)	AERATOR	FLOW STRAIGHTENER
0.1	N/A	4.8
1.0	10.8	15.2
5.0	24.0	33.9

FLOW CHART

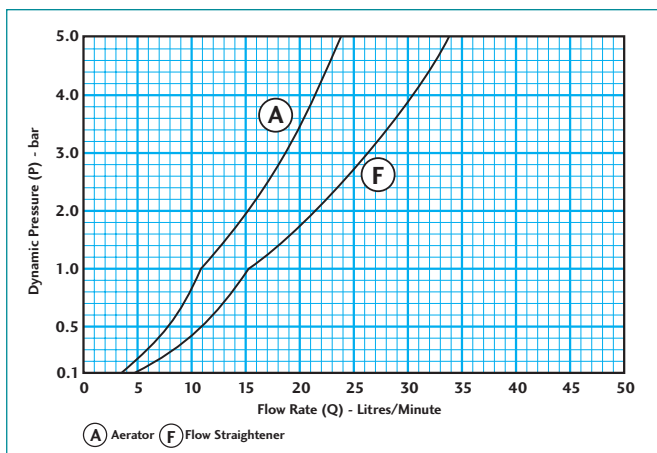

TECHNICAL INFORMATION

MATERIALS	Body BRASS Cartridge BRASS
CARTRIDGE TYPE	SELF-CLOSING, NON-CONCUSSIVE, SERVO ASSISTED DIAPHRAGM TYPE USING WATER PRESSURE TO ASSIST OPENING AND CLOSING
TIME DELAY	MAXIMUM 2 SECONDS
MAX. WORKING TEMPERATURE	70°C
OUTLET TYPE	PLASTIC FLOW STRAIGHTENER
CONNECTIONS	1/2" BSP MALE PARALLEL THREAD SUITABLE FOR TAP CONNECTOR OR 15 MM CU COMPRESSION JOINT CONNECTION
SURFACE FINISH	CHROME PLATE

RANGE/ORDER CODES

PATTERN NO.	ORDER CODE
CHROME HOT	313007
CHROME COLD	313017

RECOMMENDED OPERATING PRESSURES

MINIMUM	0.2 BAR (2 METRES) STATIC
MAXIMUM	7 BAR

FLOW RATES (LITRES/MINUTE)

DYNAMIC PRESSURES (BAR)	MINIMUM FLOW SETTING	MAXIMUM FLOW SETTING
0.1	3.0	6.0
1.0	9.5	19.0
5.0	21.2	42.4

FLOW CHART

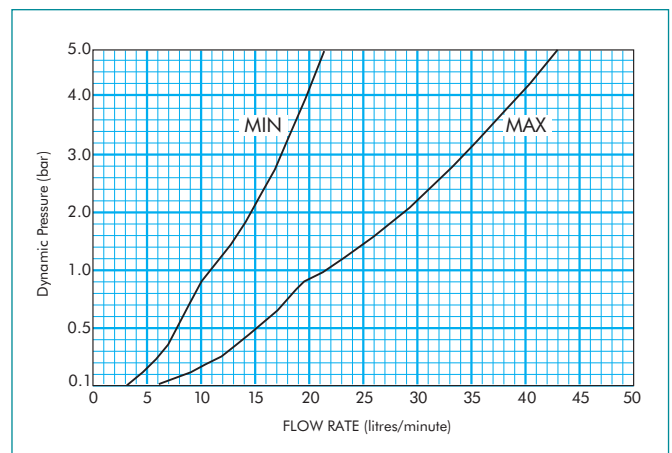

PERFORMA SELF-CLOSING BASIN TAPS



876 PRESTEX SELF-CLOSING BASIN TAP

Basin Pillar Tap with flow regulator situated under the handle for on site adjustment.

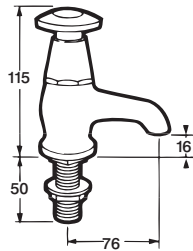

TECHNICAL INFORMATION

MATERIALS	Body BRASS Cartridge BRASS
CARTRIDGE TYPE	SELF-CLOSING, NON-CONCUSSIVE, SERVO ASSISTED DIAPHRAGM TYPE USING WATER PRESSURE TO ASSIST OPENING AND CLOSING
TIME DELAY	MAXIMUM 2 SECONDS
MAX. WORKING TEMPERATURE	70°C
OUTLET TYPE	OPEN (UNRESTRICTED)
CONNECTIONS	½" BSP MALE PARALLEL THREAD SUITABLE FOR TAP CONNECTOR OR 15MM CU COMPRESSION JOINT CONNECTION
SURFACE FINISH	CHROME PLATE

RANGE/ORDER CODES

PATTERN NO.	ORDER CODE
CHROME HOT	314007
CHROME COLD	314017

RECOMMENDED OPERATING PRESSURES

MINIMUM	0.2 BAR (2 METRES) STATIC
MAXIMUM	7 BAR

FLOW RATES (LITRES/MINUTE)

DYNAMIC PRESSURES (BAR)	MINIMUM FLOW SETTING	MAXIMUM FLOW SETTING
0.1	4.0	8.3
1.0	12.6	26.2
5.0	28.3	58.7

FLOW CHART

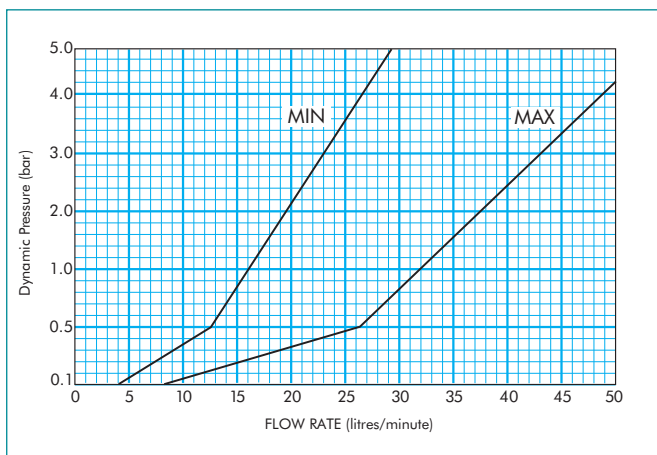

877-2 PRESTEX SELF-CLOSING BASIN TAP

Basin Pillar Tap with spray and optional flow straightener.

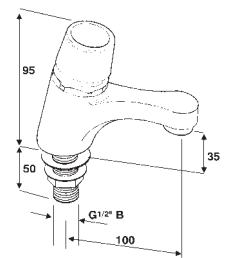

TECHNICAL INFORMATION

MATERIALS	Handle BRASS Body BRASS Cartridge PLASTIC
TIME DELAY	NON-ADJUSTABLE, 15 SECONDS IN ACCORDANCE WITH BS EN 816
MAX. WORKING TEMPERATURE	60°C
OUTLET TYPE	FLOW STRAIGHTENER SPRAY PLATE WITH FLOW RESTRICTOR INTERCHANGEABLE
CONNECTIONS	½" BSP MALE PARALLEL THREAD SUITABLE FOR CONNECTOR OR 15 MM CU COMPRESSION JOINT CONNECTION
SURFACE FINISH	CHROME PLATE

RANGE/ORDER CODES

PATTERN NO.	ORDER CODE
CHROME HOT	315037
CHROME COLD	315038

RECOMMENDED OPERATING PRESSURES

MINIMUM	0.3 BAR (3 METRES) STATIC
MAXIMUM	7 BAR

FLOW RATES (LITRES/MINUTE)

DYNAMIC PRESSURES (BAR)	AERATOR	FLOW STRAIGHTENER
0.5	2.7	12
1.0	3.9	17.4
2.5	4.5	23.4

FLOW CHART

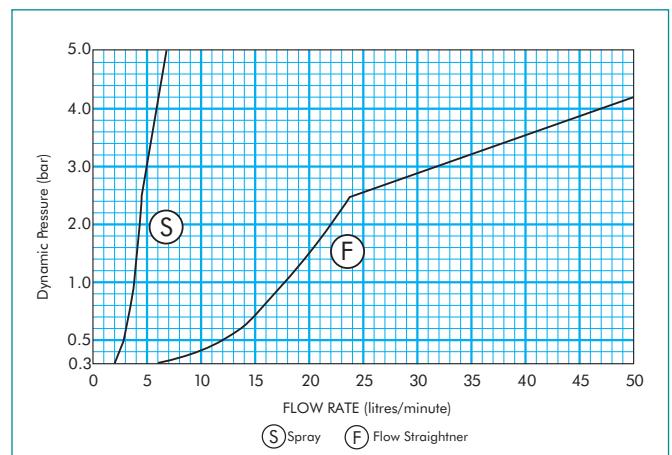

PERFORMA SELF-CLOSING BASIN TAPS



880 PRESTEX SELF-CLOSING BIB TAP

Bib tap with flow regulator situated under the handle for on site adjustment.

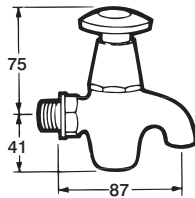

883 SELF-CLOSING BIB TAP

Bib tap with pre-set non-adjustable time delay of 15 seconds.

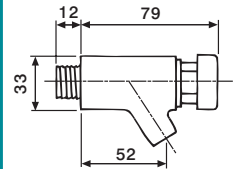

TECHNICAL INFORMATION

MATERIALS	Body BRASS Cartridge BRASS
CARTRIDGE TYPE	SELF CLOSING, NON-CONCUSSIVE, PISTON OPERATED WITH FLOW REGULATOR
TIME DELAY	MAXIMUM 2 SECONDS
MAX. WORKING TEMPERATURE	70°C
OUTLET TYPE	OPEN (UNRESTRICTED)
CONNECTIONS	½" BSP MALE PARALLEL THREAD
SURFACE FINISH	CHROME PLATE

RANGE/ORDER CODES

PATTERN NO.	ORDER CODE
CHROME HOT	317007
CHROME COLD	317017

RECOMMENDED OPERATING PRESSURES

MINIMUM	0.2 BAR
MAXIMUM	7 BAR

FLOW RATES (LITRES/MINUTE)

DYNAMIC PRESSURES (BAR)	MINIMUM FLOW SETTING	MAXIMUM FLOW SETTING
0.1	4.0	8.3
1.0	12.6	26.2
5.0	28.3	58.7

FLOW CHART

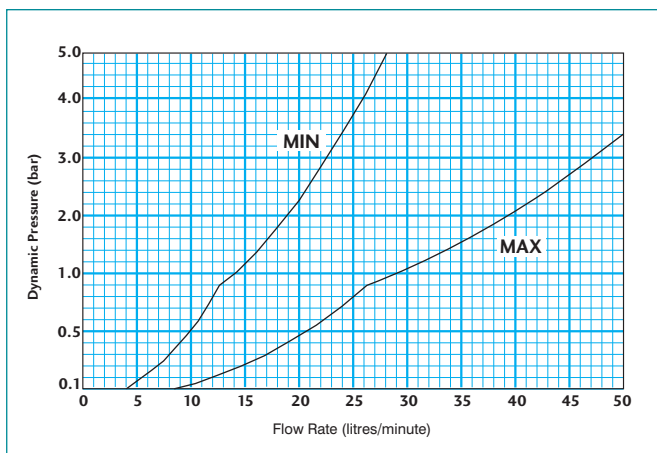

TECHNICAL INFORMATION

MATERIALS	Body BRASS Cartridge PLASTIC
CARTRIDGE TYPE	SELF CLOSING, NON-CONCUSSIVE, PISTON OPERATED WITH FLOW REGULATOR
TIME DELAY	15 SECONDS
MAX. WORKING TEMPERATURE	70°C
OUTLET TYPE	METAL FLOW STRAIGHTENER HOUSED IN OUTLET
CONNECTIONS	½" BSP MALE PARALLEL THREAD
SURFACE FINISH	CHROME PLATE

RANGE/ORDER CODES

PATTERN NO.	ORDER CODE
CHROME	347007

RECOMMENDED OPERATING PRESSURES

MINIMUM	0.2 BAR
MAXIMUM	6 BAR

FLOW RATES (LITRES/MINUTE)

DYNAMIC PRESSURES (BAR)	OPEN OUTLET
0.1	4.8
1.0	15.2
5.0	33.9

FLOW CHART

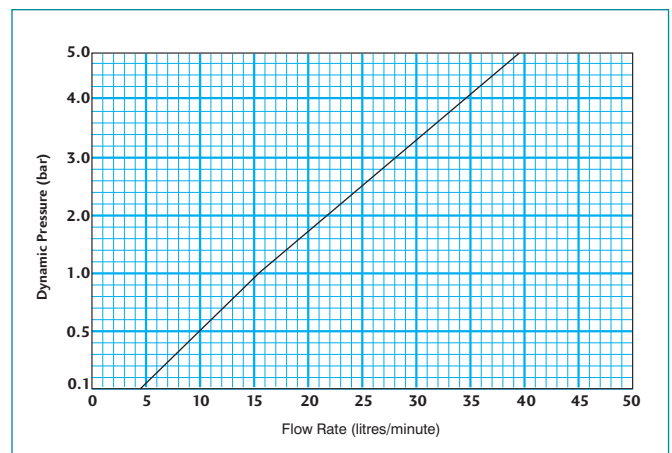

PERFORMA SELF-CLOSING BASIN TAPS



884 SELF-CLOSING STOP VALVE

Stop valve with flow regulator situated under the handle for on site adjustment.

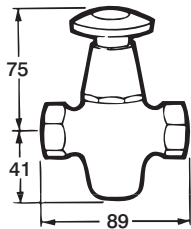

TECHNICAL INFORMATION

MATERIALS	Body BRASS Cartridge BRASS
CARTRIDGE TYPE	SELF CLOSING, NON-CONCUSSIVE, PISTON OPERATED WITH FLOW REGULATOR
TIME DELAY	MAXIMUM 2 SECONDS
MAX. WORKING TEMPERATURE	70°C
OUTLET TYPE	OPEN (UNRESTRICTED)
CONNECTIONS	½" BSP FEMALE TAPER THREAD
SURFACE FINISH	CHROME PLATE

RANGE/ORDER CODES

PATTERN NO.	ORDER CODE
CHROME	318017

RECOMMENDED OPERATING PRESSURES

MINIMUM	0.2 BAR
MAXIMUM	7 BAR

FLOW RATES (LITRES/MINUTE)

DYNAMIC PRESSURES (BAR)	MINIMUM FLOW SETTING	MAXIMUM FLOW SETTING
0.1	4.0	9.3
1.0	12.6	26.2
5.0	28.3	58.7

FLOW CHART

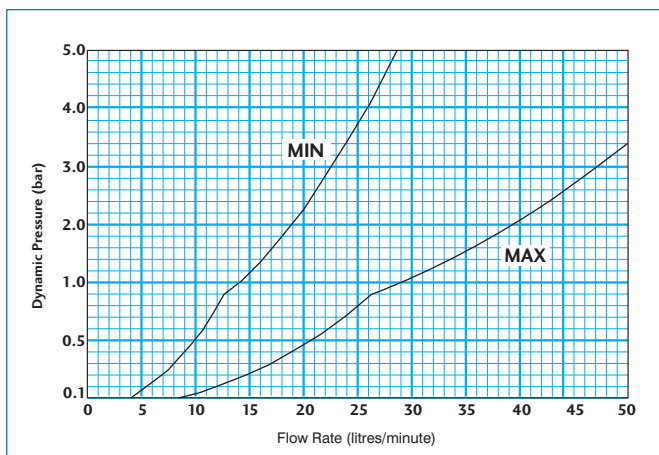

871 SELF-CLOSING BASIN TAP

Basin Pillar Tap with pre-set, non-adjustable time delay of 15 seconds. Supplied with flow straightener fitted and interchangeable anti-splash aerator for high pressure.

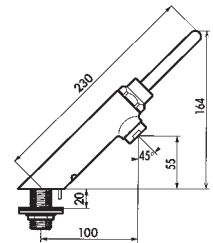

TECHNICAL INFORMATION

MATERIALS	Lever BRASS Body BRASS Cartridge PLASTIC
TIME DELAY	NON-ADJUSTABLE, 15 SECONDS IN ACCORDANCE WITH BS EN 816
MAX. WORKING TEMPERATURE	70°C
OUTLET TYPE	PLASTIC FLOW STRAIGHTENER. INTERCHANGEABLE ANTI-SPLASH AERATOR SUPPLIED LOOSE FOR USE AT PRESSURE ABOVE 1 BAR
CONNECTIONS	½" BSP MALE PARALLEL THREAD SUITABLE FOR TAP CONNECTOR OR 15MM CU COMPRESSION JOINT CONNECTION
SURFACE FINISH	CHROME PLATE

RANGE/ORDER CODES

PATTERN NO.	ORDER CODE
CHROME	341007

RECOMMENDED OPERATING PRESSURES

MINIMUM	0.2 BAR (2 METRES) STATIC
MAXIMUM	6 BAR

FLOW RATES (LITRES/MINUTE)

DYNAMIC PRESSURES (BAR)	AERATOR	FLOW STRAIGHTENER
0.1	N/A	4.8
1.0	10.8	15.2
5.0	24.0	33.9

FLOW CHART

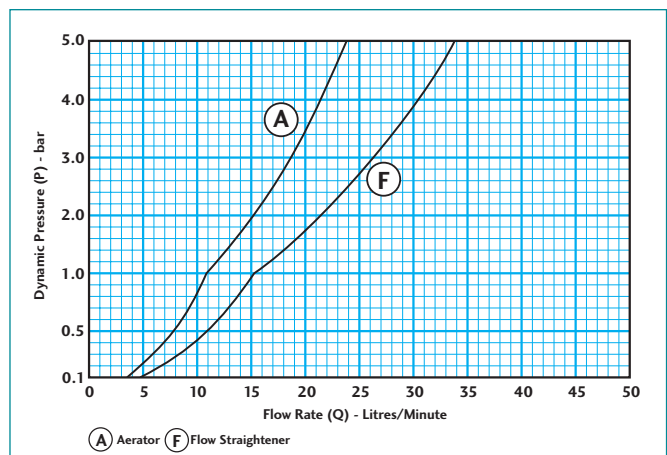

PERFORMA SELF-CLOSING BASIN TAPS



897 BASIN SPOUT WALL MOUNTED (FOR USE WITH 882)

Wall mounted basin spout supplied with flow straightener and anti-splash aerator.

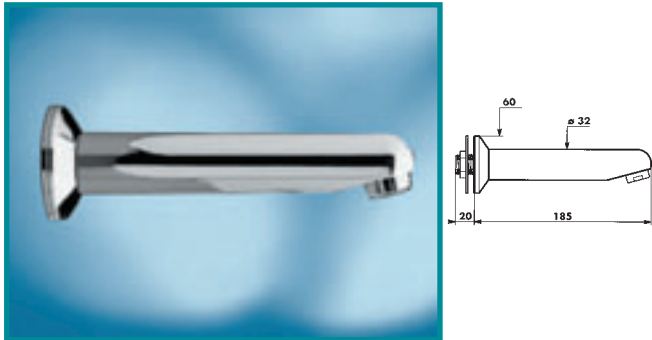

TECHNICAL INFORMATION

MATERIALS	Body BRASS
PROJECTION	170MM FROM WALL SURFACE TO CENTRE OF OUTLET
OUTLET TYPE	PLASTIC FLOW STRAIGHTENER HOUSED IN BRASS CASING FITTED. INTERCHANGEABLE ANTI-SPLASH AERATOR SUPPLIED LOOSE IN BOX FOR USE AT PRESSURES ABOVE 1 BAR.
CONNECTIONS	½" BSP MALE PARALLEL THREAD
SURFACE FINISH	CHROME PLATE

RANGE/ORDER CODES

PATTERN NO.	ORDER CODE
CHROME	346007

RECOMMENDED OPERATING PRESSURES

MINIMUM	0.2 BAR (2 METRES) STATIC
MAXIMUM	6 BAR

FLOW RATES (LITRES/MINUTE)

DYNAMIC PRESSURES (BAR)	AERATOR	FLOW STRAIGHTENER
0.1	N/A	7.2
1.0	13.6	22.8
5.0	30.4	50.9

FLOW CHART

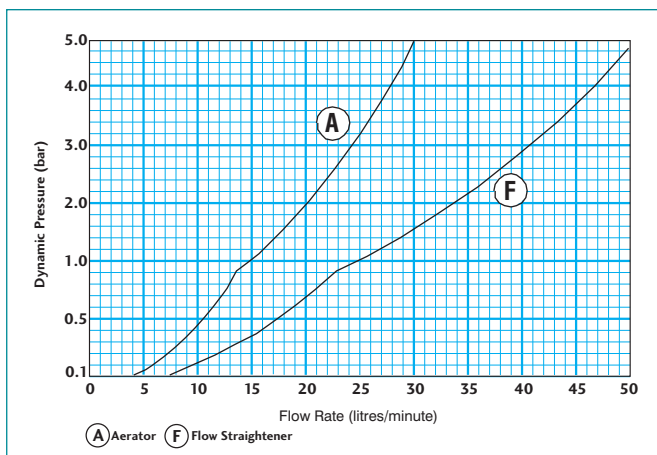

899 BASIN SPOUT DECK MOUNTED (FOR USE WITH 882)

Deck mounted basin spout supplied with flow straightener and anti-splash aerator.

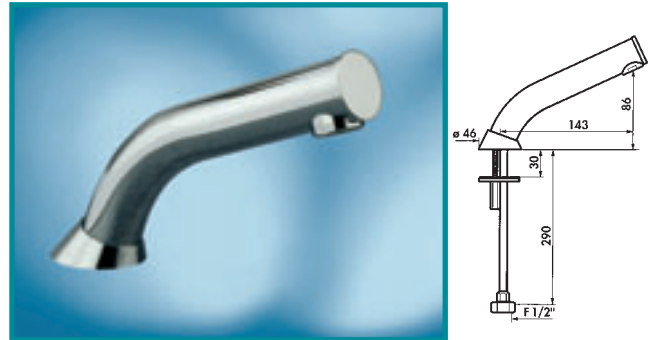

TECHNICAL INFORMATION

MATERIALS	Outlet BRASS Inlet PLASTIC TUBE
PROJECTION	143MM FROM CENTRE OF SPOUT TO CENTRE OF OUTLET
OUTLET TYPE	PLASTIC FLOW STRAIGHTENER HOUSED IN BRASS CASING FITTED. INTERCHANGEABLE ANTI-SPLASH AERATOR SUPPLIED LOOSE IN BOX FOR USE AT PRESSURES ABOVE 1 BAR
CONNECTIONS	½" BSP FEMALE PARALLEL THREAD
SURFACE FINISH	CHROME PLATE

RANGE/ORDER CODES

PATTERN NO.	ORDER CODE
CHROME	346009

RECOMMENDED OPERATING PRESSURES

MINIMUM	0.2 BAR (2 METRES) STATIC
MAXIMUM	6 BAR

FLOW RATES (LITRES/MINUTE)

DYNAMIC PRESSURES (BAR)	AERATOR	FLOW STRAIGHTENER
0.1	N/A	9.0
1.0	13.6	28.5
5.0	30.4	63.6

FLOW CHART

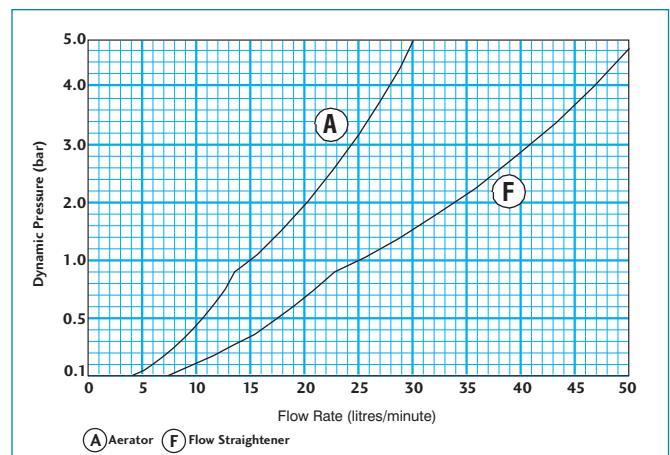

PERFORMA MONOBLOC SELF-CLOSING BASIN MIXER



877V MONOBLOC SELF-CLOSING BASIN TAP

Basin Pillar Tap with spray and optional flow straightener.

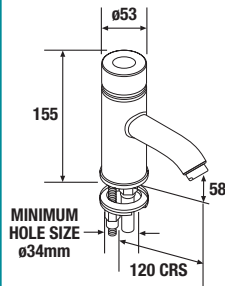

TECHNICAL INFORMATION

MATERIALS	Handle: BRASS Body: BRASS Cartridge: PLASTIC
TIME DELAY	NON-ADJUSTABLE, 15 SECONDS IN ACCORDANCE WITH BS EN 816
MAX. WORKING TEMPERATURE	60°C
OUTLET TYPE	FLOW STRAIGHTENER SPRAY PLATE WITH FLOW RESTRICTOR INTERCHANGEABLE
CONNECTIONS	½" BSP MALE PARALLEL THREAD SUITABLE FOR TAP CONNECTOR OR 15MM CU COMPRESSION JOINT CONNECTION
SURFACE FINISH	CHROME PLATE
MAX. THICKNESS OF WARE/WORKTOP	45MM

RANGE/ORDER CODES

PATTERN NO.	ORDER CODE
CHROME	315050

RECOMMENDED OPERATING PRESSURES

MINIMUM	0.3 BAR (3 METRES) STATIC
MAXIMUM	7 BAR

FLOW RATES (LITRES/MINUTE)

DYNAMIC PRESSURES (BAR)	SPRAY	FLOW STRAIGHTENER
0.3	2.0	6.0
0.5	2.7	12.0
1.0	3.9	17.4
2.5	4.5	23.4
5.0	6.8	62.0

FLOW CHART

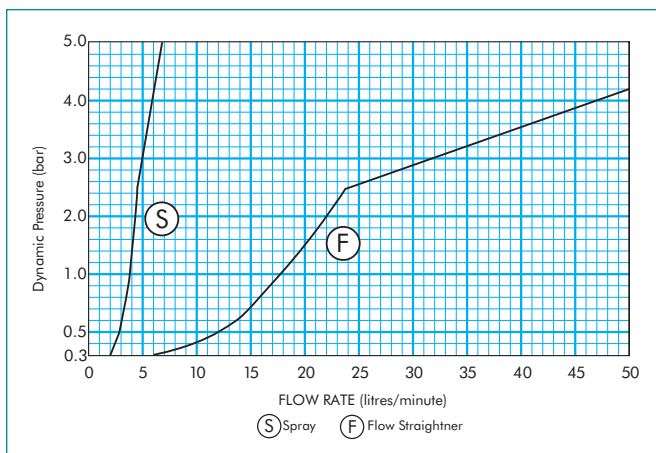

PERFORMA MONOBLOC LEVER OPERATED BASIN MIXER

401 LEVER OPERATED MONOBLOC MIXER

Lever operated monobloc mixer with spray outlet (incorporating adjustable flow regulator) and flow straightener. temperature limit stop situated under handle for on site setting.

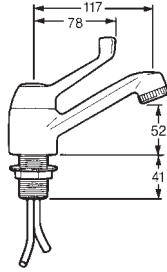

TECHNICAL INFORMATION

MATERIALS	Body BRASS Spray Outlet PLASTIC/BRASS Headwork BRASS Lever BRASS
CARTRIDGE TYPE	SEQUENTIAL MIX FROM OFF THROUGH COLD TO HOT IN 125° ARC OF MOVEMENT (WHEN LIMIT STOP NOT USED).
MAX. WORKING TEMPERATURE	80°C
MAX. OUTLET TEMPERATURE	BRASS PLATE LOCATED ON SPINDLE. ADJUSTABLE TO SUIT SYSTEM INLET TEMPERATURES AND USER REQUIREMENTS. NOTE: STABLE OUTLET TEMPERATURES ARE DEPENDANT ON PRESSURE AND TEMPERATURE SUPPLY BEING CONSTANT.
OUTLET TYPE	SPRAY OUTLET FITTED WHICH INCORPORATES AN ADJUSTABLE FLOW REGULATOR FOR ON SITE ADJUSTMENT.
FLEXIBLE TAIL	½" BSP X 10"
INLET SHANK	¾" BSP (26.4MM OD)
SURFACE FINISH	CHROME PLATE

RANGE/ORDER CODES

PATTERN NO.	ORDER CODE
CHROME	319007

RECOMMENDED OPERATING PRESSURES

MINIMUM	0.2 BAR
MAXIMUM	10 BAR

401 FLOW RATES (LITRES/MINUTE)

DYNAMIC PRESSURES (BAR)	SPRAY WITH REGULATOR EQUAL MIX	FLOW STRAIGHTENER EQUAL MIX
0.1	0.95	1.85
0.5	2.0	4.2
1	2.4	6.0
5	3.5	12.3

Note: Flow straightener requires a minimum of 0.5 bar pressure for satisfactory flow rates for basin filling.



401 PEGLESPRAY MONOBLOC MIXER WITH FLEXITAILS

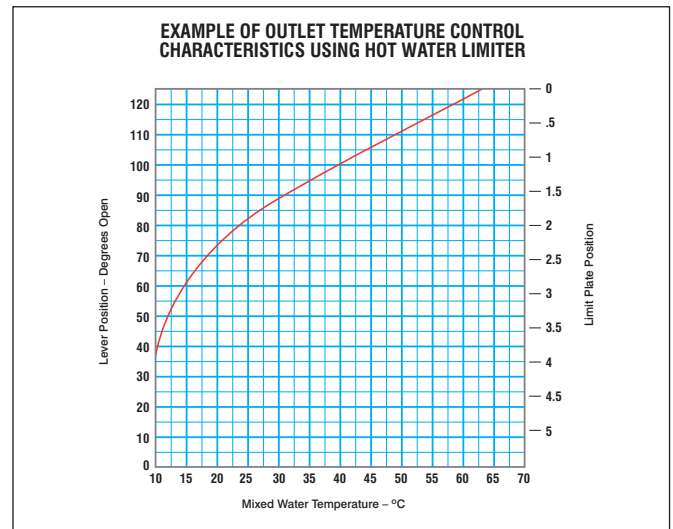
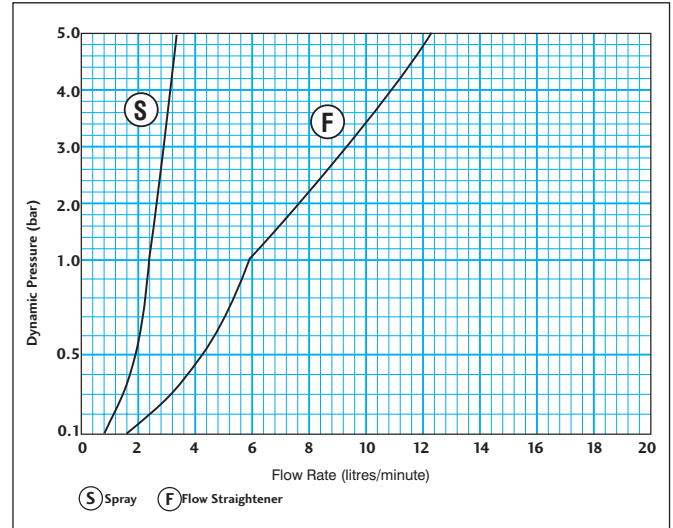

NOTES:

- I) Hot water temperature at 70°C, cold water temperature at 10°C.
- II) Balanced hot and cold supply pressures.
- III) Half positions are gained by inverting the Limit Plate.
- IV) Stable outlet temperatures are dependant on hot and cold inlet pressures and temperatures remaining constant.



882 LEVER OPERATED FLOW CONTROL

Lever operated self-closing flow control with pre-set, non-adjustable time delay of 7 seconds for exposed inlet and outlet supplies.

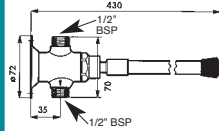
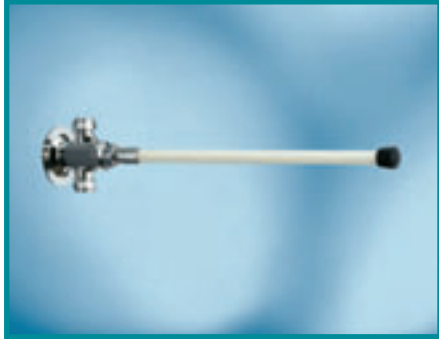

TECHNICAL INFORMATION

MATERIALS	Lever PLASTIC Body BRASS Cartridge PLASTIC
TIME DELAY	NON-ADJUSTABLE, 7 SECONDS IN ACCORDANCE WITH BS EN 816.
MAX. WORKING TEMPERATURE	70°C
CONNECTIONS	15MM CU COMPRESSION CONNECTIONS FOR INLET AND OUTLET (SUPPLIED)
SURFACE FINISH	CHROME PLATE

RANGE/ORDER CODES

PATTERN NO.	ORDER CODE
CHROME	342009

RECOMMENDED OPERATING PRESSURES

MINIMUM	0.2 BAR (2 METRES) STATIC.
MAXIMUM	6 BAR

FLOW RATES (LITRES/MINUTE)

DYNAMIC PRESSURES (BAR)	OPEN OUTLET
0.1	4.1
1.0	12.9
5.0	29.0

FLOW CHART

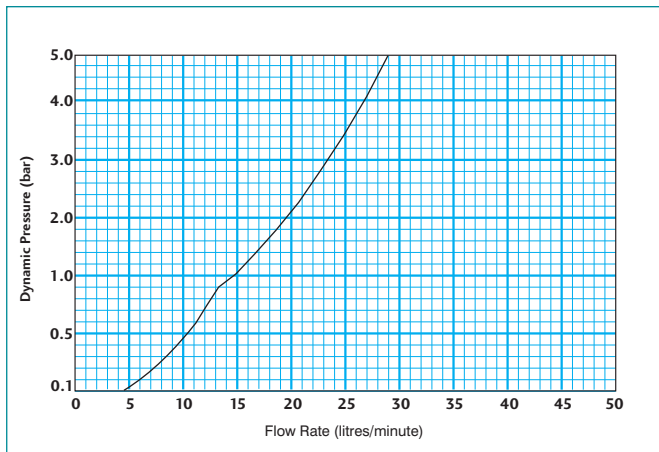

PERFORMA ELECTRONIC BASIN OUTLETS



885 DECK MOUNTED ELECTRONIC OUTLET

The 885 deck mounted basin outlet is supplied complete with integrated sensor, control module and solenoid valve.

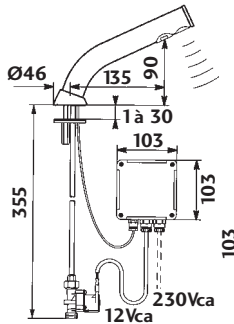

ELECTRICAL INFORMATION

CONTROL MODULE/ TRANSFORMER	Primary: 220/240V AC 50 HZ Secondary: 12V AC 50 HZ Fuses: PRIMARY 0.6 AMP. SECONDARY 1 AMP. IP Rating: 55 Standards: CONFORMS TO EN 60742 Distance Limits: MOUNT WITHIN 1 METRE OF OUTLET Cable Requirements: PRIMARY TO CURRENT IEE REGS
OPERATING TEMPERATURE RANGE	0°C TO 35°C (INSIDE ELECTRONIC BOX)
MAX. HUMIDITY	95%
CURRENT RATING	6.6 WATTS
POWER SUPPLY	TO BE VIA A CONNECTION UNIT FUSED AT 3A
SOLENOID VALVE	12V AC 50 HZ
CABLE REQUIREMENT TO CONTROL MODULE	ROUND FLEXIBLE 3 CORE CABLE
OUTLET SENSOR	12V AC 50 HZ

886 WALL MOUNTED ELECTRONIC OUTLET

The 886 wall mounted basin outlet is supplied complete with integrated sensor, control module and solenoid valve.

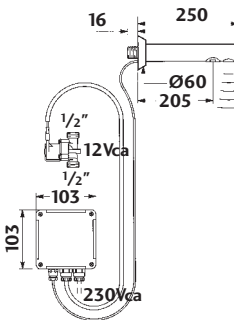

TECHNICAL INFORMATION

MATERIALS STEEL/FLEXIBLE	Outlet BRASS Inlet BRASS
SENSOR TYPE	INFRA RED DETECTOR UNDER SENSOR. THE DEPTH OF FIELD DETECTION IS ADJUSTABLE
MAX. WORKING TEMPERATURE	60°C
OUTLET TYPE	PLASTIC FLOW STRAIGHTENER
CONNECTIONS	885 1/2\" BSP FEMALE PARALLEL THREAD 886/7 1/2\" BSP MALE PARALLEL THREAD
SURFACE FINISH	CHROME PLATE
MAX. THICKNESS OF WARE/WORKTOP	1-40MM
MAX. THICKNESS OF WALL	45MM (EXTENSION PIECES ARE AVAILABLE FOR BLOCK WALLS)
ELECTRICAL CONNECTION	30\" OF 2 CORE SCREENED CABLE OF MODULE

887 WALL MOUNTED ELECTRONIC OUTLET (SHORT SPOUT)

The 887 wall mounted basin outlet is supplied complete with integrated sensor, control module and solenoid valve.

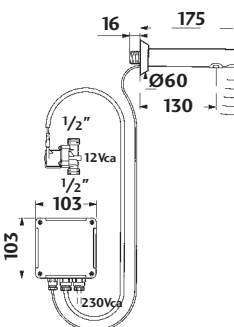

RANGE/ORDER CODES

PATTERN NO.	ORDER CODE
885	343007
886	343009
887	343011

RECOMMENDED OPERATING PRESSURES

MINIMUM	0.2 BAR (2 METRES) STATIC
MAXIMUM	6 BAR

FLOW CHART

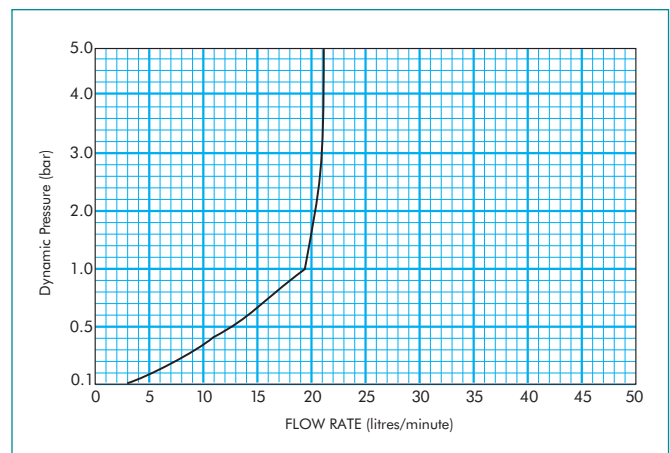

PERFORMA MONOBLOC ELECTRONIC BASIN MIXERS



885V MONOBLOC BASIN MIXER

Visio-Tek electronic basin taps are of robust construction and incorporate many vandal-deterrent features, making them ideal for applications subject to frequent usage or prevent possible abuse.

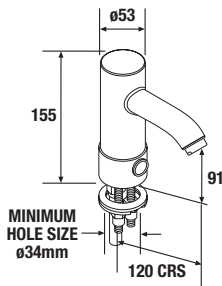

886V WALL MOUNTED ELECTRONIC MIXER

Visio-Tek electronic wall-mounted taps are of robust construction and incorporate many vandal-deterrent features, making them ideal for applications subject to frequent usage or prevent possible abuse.

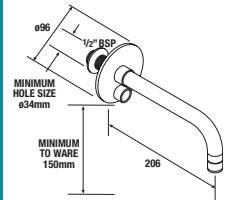

TECHNICAL INFORMATION

MATERIALS	Outlet BRASS Inlet STAINLESS STEEL/FLEXIBLE
SENSOR TYPE	INFRA RED DETECTOR UNDER SENSOR
MAX. WORKING TEMPERATURE	60°C
OUTLET TYPE	SPRAY OR FLOW STRAIGHTENER
WATER CONNECTIONS	1/2" BSP MALE PARALLEL THREAD
SURFACE FINISH	CHROME PLATE
MAX. THICKNESS OF WARE/WORKTOP	1-40MM
MAX. THICKNESS OF WALL	45MM (EXTENSION PIECES ARE AVAILABLE FOR BLOCK WALLS)
ELECTRICAL CONNECTION	1 METRE OF 2 CORE SCREENED CABLE OF MODULE
OUTLET SENSOR	8V AC

RANGE/ORDER CODES

PATTERN NO.	ORDER CODE
CHROME	343027

RECOMMENDED OPERATING PRESSURES

MINIMUM	0.2 BAR (2 METRES) STATIC
MAXIMUM	6 BAR

FLOW RATES (LITRES/MINUTE)

DYNAMIC PRESSURES (BAR)	SPRAY	FLOW STRAIGHTENER
0.2	2.8	8.6
0.5	3.3	12.0
1.0	4.2	16.2
2.5	5.3	25.2
5.0	6.0	36.6

FLOW CHART

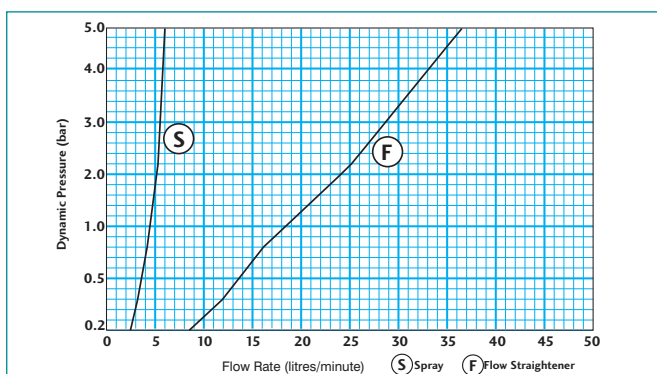

TECHNICAL INFORMATION

MATERIALS	Outlet BRASS Inlet STAINLESS STEEL/FLEXIBLE
SENSOR TYPE	INFRA RED DETECTOR UNDER SENSOR
MAX. WORKING TEMPERATURE	60°C
OUTLET TYPE	LAMINATED FLOW STRAIGHTENER
WATER CONNECTIONS	1/2" BSP MALE PARALLEL THREAD
SURFACE FINISH	CHROME PLATE
MAX. THICKNESS OF WARE/WORKTOP	1-40MM
MAX. THICKNESS OF WALL	45MM (EXTENSION PIECES ARE AVAILABLE FOR BLOCK WALLS)
ELECTRICAL CONNECTION	1 METRE OF 2 CORE SCREENED CABLE OF MODULE
OUTLET SENSOR	8V AC

RANGE/ORDER CODES

PATTERN NO.	ORDER CODE
CHROME	343029

RECOMMENDED OPERATING PRESSURES

MINIMUM	0.2 BAR (2 METRES) STATIC
MAXIMUM	6 BAR

FLOW RATES (LITRES/MINUTE)

DYNAMIC PRESSURES (BAR)	LAMINATED FLOW STRAIGHTENER
0.2	3.2
0.5	3.6
1.0	4.8
2.5	6.9
5.0	7.5

FLOW CHART

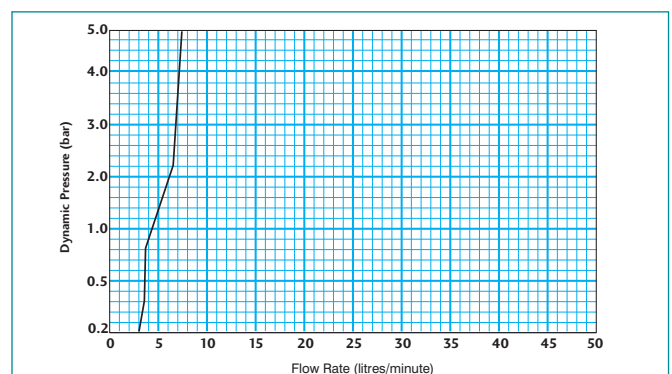



CONTROL MODULE AND TRANSFORMER

SOLENOID VALVE

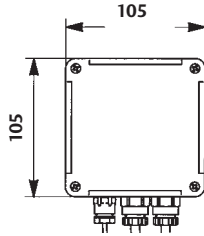

All electrical components are housed within a strong plastic casing conforming to IP 55. Demountable electrical connections are protected via stuffing boxes with rubber glands. Module must be situated within one metre of outlet. Fix to wall via screws in a dry area underneath the basin or behind duct wall.

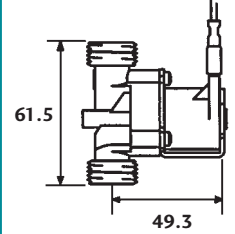

TECHNICAL INFORMATION

MATERIALS	GLASS FILLED NYLON
CONNECTIONS	<i>Water</i> INLET AND OUTLET 1/2" BSP MALE PARALLEL THREAD (FILTER INCLUDED ON INLET SIDE) <i>Electrical</i> VIA 2 SPADE END CONNECTORS

FLOW RATES (LITRES/MINUTE)

DYNAMIC PRESSURES (BAR)	FLOW THROUGH SOLENOID AND OUTLET
0.5	10.8
1.0	19.2
5.0	21.0

PERFORMA SELF-CLOSING SHOWER CONTROLS



890 SELF-CLOSING SHOWER FLOW CONTROL (FOR USE WITH 891)

Exposed shower flow control with pre-set non-adjustable time delay of 30 seconds.

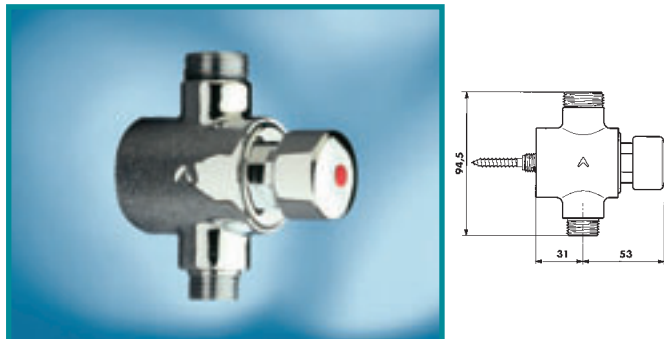

TECHNICAL INFORMATION

MATERIALS	Body BRASS Piston BRASS
TIME DELAY	NON-ADJUSTABLE, 30 SECONDS IN ACCORDANCE WITH BS EN 816
MAX. WORKING TEMPERATURE	70°C
CONNECTIONS	Inlet: 1/2" BSP MALE PARALLEL THREAD Outlet: 3/4" BSP MALE PARALLEL THREAD SUITABLE FOR COUPLING TO 891 3/4" RISER PIPE CONNECTION
SURFACE FINISH	CHROME PLATE

RANGE/ORDER CODES

PATTERN NO.	ORDER CODE
CHROME	344008

RECOMMENDED OPERATING PRESSURES

MINIMUM	0.2 BAR
MAXIMUM	6 BAR

FLOW RATES (LITRES/MINUTE)

DYNAMIC PRESSURES (BAR)	OPEN OUTLET (I.E. NO SHOWER HEAD)
0.1	4.5
1.0	48
5.0	83

FLOW CHART

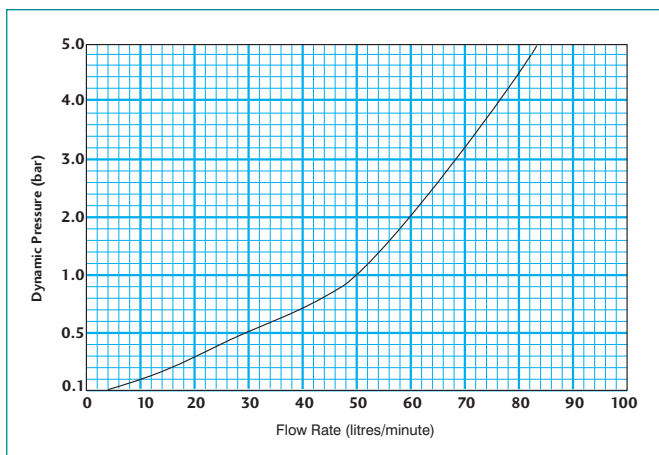

893 SELF-CLOSING SHOWER FLOW CONTROL (FOR USE WITH 896)

Concealed shower flow control with pre-set non-adjustable time delay of 30 seconds.

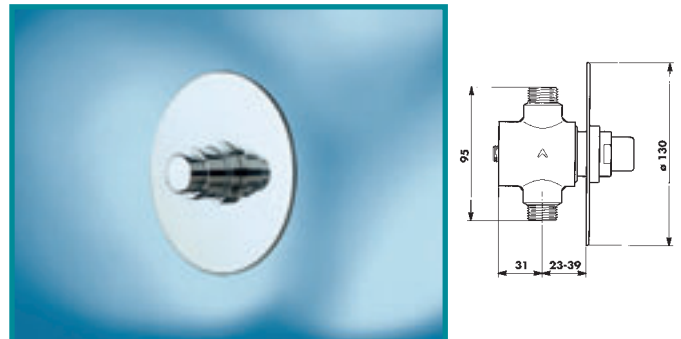

TECHNICAL INFORMATION

MATERIALS	Body BRASS Cover Plate STAINLESS STEEL Piston BRASS
TIME DELAY	NON-ADJUSTABLE, 30 SECONDS IN ACCORDANCE WITH BS EN 816
MAX. WORKING TEMPERATURE	70°C
CONNECTIONS	Inlet and Outlet: 1/2" BSP MALE PARALLEL THREAD FOR COMPRESSION FITTINGS
SURFACE FINISH	CHROME PLATE
COVER PLATE FIXING	FIXED TO BODY WITH ANTI-VANDAL LOCKING RING AND SECURED WITH GRUB SCREW

RANGE/ORDER CODES

PATTERN NO.	ORDER CODE
CHROME	344009

RECOMMENDED OPERATING PRESSURES

MINIMUM	0.2 BAR
MAXIMUM	6 BAR

FLOW RATES (LITRES/MINUTE)

DYNAMIC PRESSURES (BAR)	OPEN OUTLET (I.E. NO SHOWER HEAD)
0.1	4.5
1.0	48
5.0	83

FLOW CHART

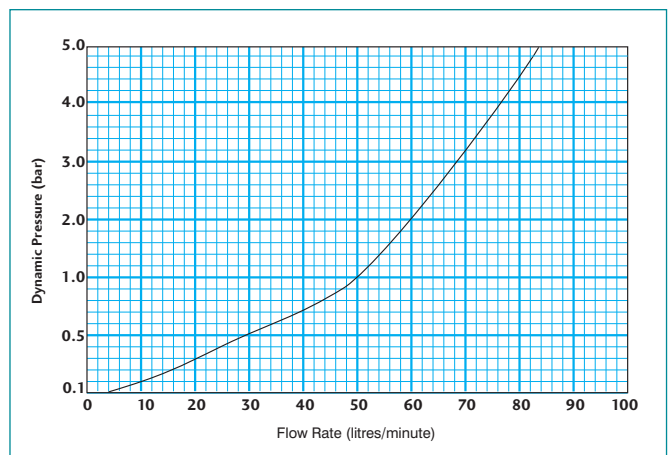

PERFORMA SHOWER RISERS AND HEADS



891 EXPOSED RISER PIPE WITH ANTI-VANDAL SPRAY HEAD

Exposed riser pipe and anti-vandal spray head with plastic spray plates secured by allen key grubscrew for use with 890 shower flow control.

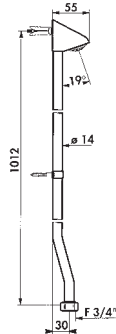

896 ANTI-VANDAL SPRAY HEAD

Concealed spray head with plastic spray plates secured with allen key grubscrew for use with 893 concealed shower flow control.

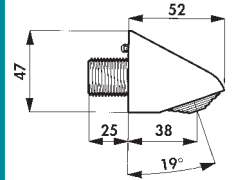

TECHNICAL INFORMATION

MATERIALS	Head BRASS Spray Plates PLASTIC Riser Pipe BRASS
MAX. WORKING TEMPERATURE	70°C
CONNECTIONS	3/4" BSP FEMALE THREAD FROM RISER PIPE TO SHOWER CONTROL
SURFACE FINISH	CHROME PLATE
WALL FIXING	Shower Head: FIX TO WALL USING METAL SPLAYED FIXING PLUG PROVIDED Riser Pipe: CLAMPED TO WALL USING PIPE CLIP PROVIDED

TECHNICAL INFORMATION

MATERIALS	Head BRASS Spray Plates PLASTIC
MAX. WORKING TEMPERATURE	70°C
CONNECTIONS	1/2" BSP MALE THREAD
SURFACE FINISH	CHROME PLATE

RANGE/ORDER CODES

PATTERN NO.	ORDER CODE
CHROME	345007

RANGE/ORDER CODES

PATTERN NO.	ORDER CODE
CHROME	345009

RECOMMENDED OPERATING PRESSURES

MINIMUM	0.2 BAR
MAXIMUM	6 BAR

RECOMMENDED OPERATING PRESSURES

MINIMUM	0.2 BAR
MAXIMUM	7 BAR

FLOW RATES (LITRES/MINUTE)

DYNAMIC PRESSURES (BAR)	SPRAY
0.1	7.8
1.0	15.6
5.0	39

FLOW RATES (LITRES/MINUTE)

DYNAMIC PRESSURES (BAR)	SPRAY
0.1	7.8
1.0	15.6
5.0	39

FLOW CHART

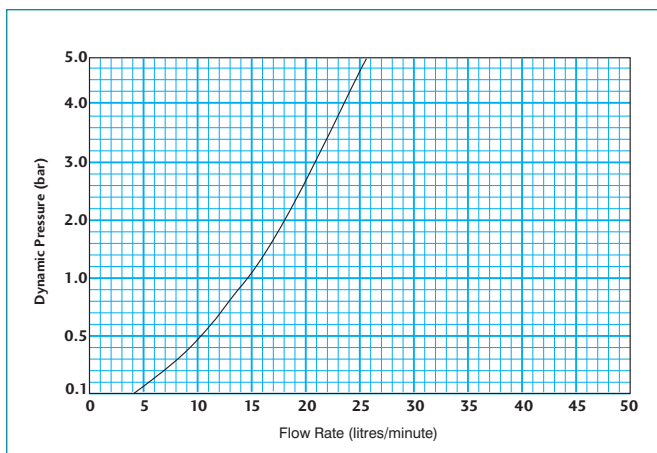

FLOW CHART

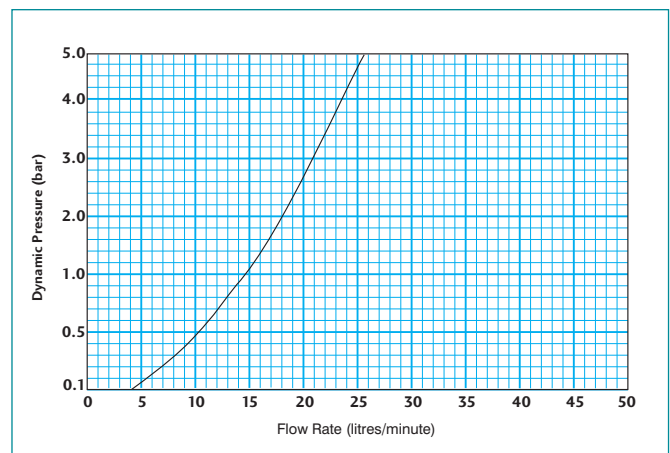

PEGLERTHERM IN-LINE MIXING VALVES

402H, 402U AND 402UA

Peglertherm in-line mixing valves are designed to eliminate the risk of scalding and are suitable for use in a wide range of public, health care, social, commercial and domestic applications.

- Suitable for sinks, wash basins, bath, bidets, single point showers, hair wash sprays and domestic hot water systems.
- Simple to install and service.
- Temperature pre-set to 43°C, but easily adjustable on site.
- WRAS approved for a wide variety of uses.
- Complies with NHS Model Engineering Specification DO8.
- Choice of standard connections 402H or easy to service 402U with union connections and 402UA with 90° angle side cocks.



DIMENSIONS (MM)

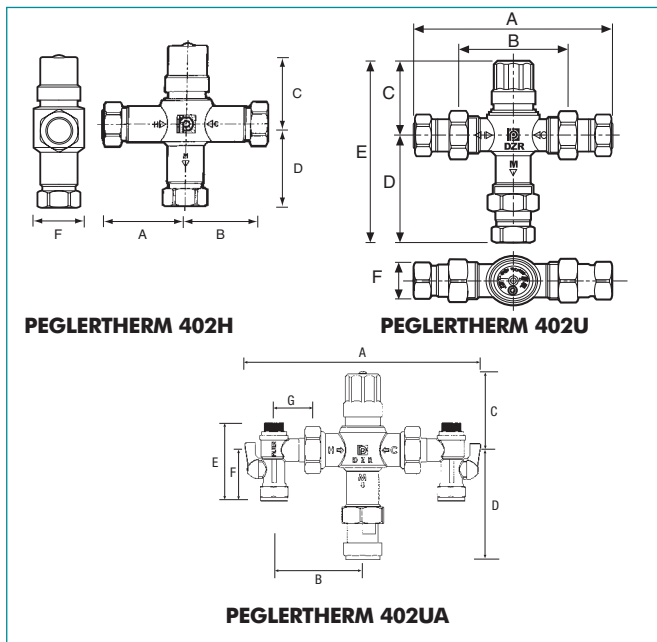

SIZES	402H	402U	402UA 15MM	402UA 22MM
A	67	159	210	224
B	67	88	80	90
C	68	60	65	65
D	63	88	100	100
E	-	148	70	90
F	43	43	45	60
G	-	-	35	45

RANGE/ORDER CODES

PATTERN NO.	ORDER CODE
402H	5A1002
402U	5A1003
402UA - 15MM	5A1004
402UA - 22MM	5A1005

TECHNICAL INFORMATION

MATERIALS	Body: DZR BRASS
PRE-SET TEMPERATURE	43°C
CONNECTIONS	402H: 22MM COMPRESSION WITH 15MM REDUCING SET SUPPLIED 402U: 22MM COMPRESSION WITH 15MM REDUCING SET AND UNION CONNECTIONS SUPPLIED 402UA - 15mm: COMPRESSION ALL ENDS 402UA - 22mm: COMPRESSION ALL ENDS
SURFACE FINISH	402H and 402U: NICKEL PLATE 402UA: NICKEL PLATE

RECOMMENDED OPERATING PRESSURES 402H, 402U AND 402UA

OPERATING PRESSURE RANGE	HIGH PRESSURE	LOW PRESSURE
MAX. STATIC PRESSURE (BAR)	10	10
FLOW PRESSURE, HOT AND COLD (BAR)	1-5	0.2-1
HOT SUPPLY TEMPERATURE (°C)	52-65	52-65
COLD SUPPLY TEMPERATURE (°C)	5-20	5-20

FLOW CHART

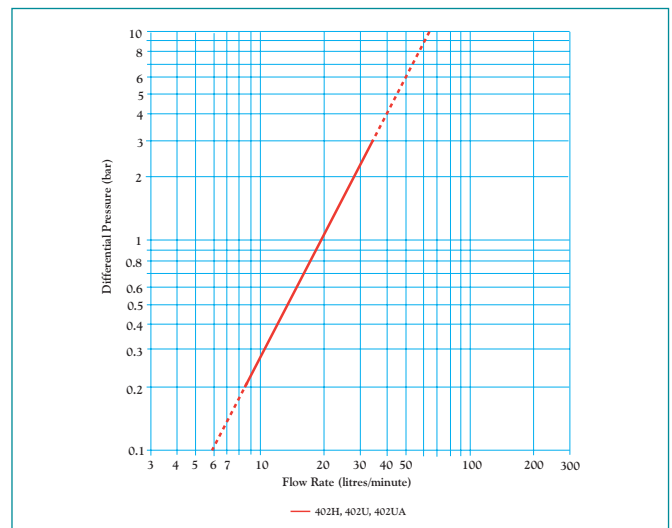

PEGLERTHERM IN-LINE MIXING VALVES

404 AND 404UA

Peglertherm in-line mixing valves are designed to eliminate the risk of scalding and are suitable for use in a wide range of public, social housing, commercial and domestic applications.

- Suitable for sinks, wash basins, bath, bidets, single point showers, hair wash sprays and domestic hot water systems.
- Simple to install and service.
- Temperature pre-set to 43°C, but easily adjustable on site.
- WRAS approved for a wide variety of uses.



DIMENSIONS (MM)

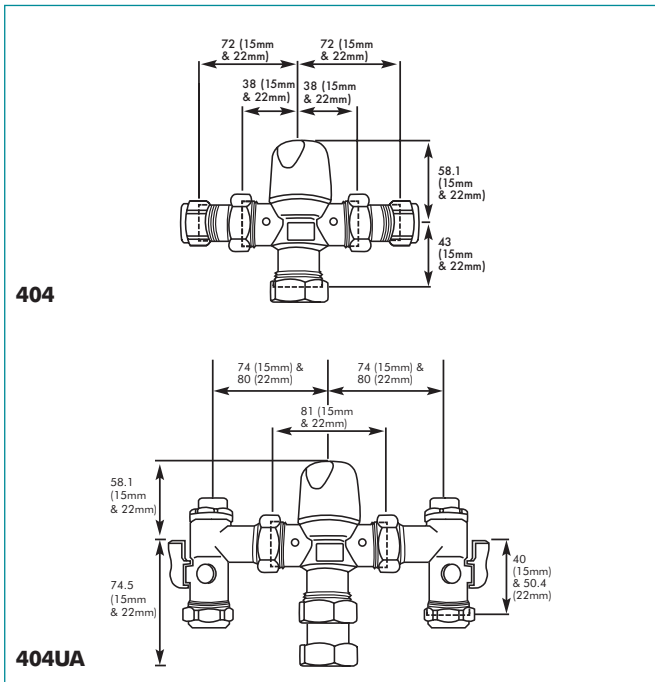

TECHNICAL INFORMATION

MATERIALS	Body: DZR BRASS
PRE-SET TEMPERATURE	43°C
WATER CONNECTIONS	404: 15MM, 22MM, WAFER STRAINERS, SINGLE CHECK VALVES ON INLETS 404UA: 15MM, 22MM, SINGLE CHECK VALVES ON INLETS, ANGLE VALVES WITH STRAINERS, ISOLATING VALVES, TEST POINTS
SURFACE FINISH	NICKEL PLATE

FLOW CHART

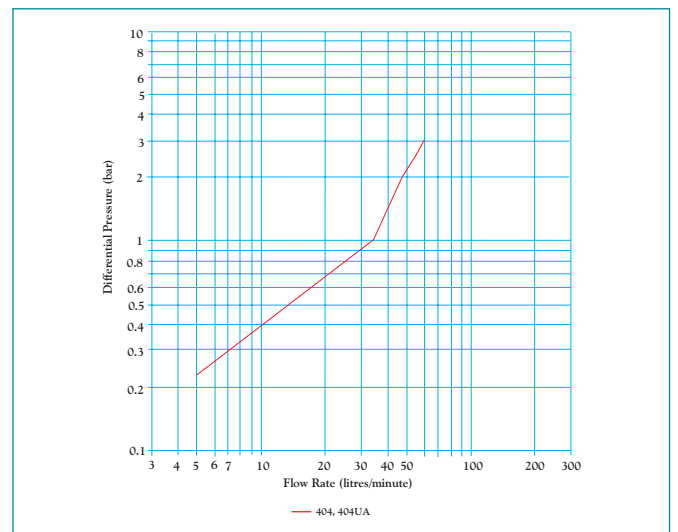

RANGE/ORDER CODES

PATTERN NO.	ORDER CODE
15MM 404	5A1020
22MM 404	5A1021
15MM 404UA	5A1022
22MM 404UA	5A1023

RECOMMENDED OPERATING PRESSURES

MINIMUM	0.1 BAR
MAXIMUM	5 BAR

OPTIFLUSH URINAL FLUSH CONTROLLERS

Advanced Pegler Optiflush uses demand activated passive infra-red sensing technology, and passes every test with flying colours.

- Reduce water usage by as much as 80%.
- Battery or mains operated.
- Suitable from 0.05 bar to 12 bar.
- Flushes automatically every 12 hours.
- Easy installation.
- Complies with Water Supply (Water Fittings) Regulations 1999 Section 9 R25.



DIMENSIONS (MM)

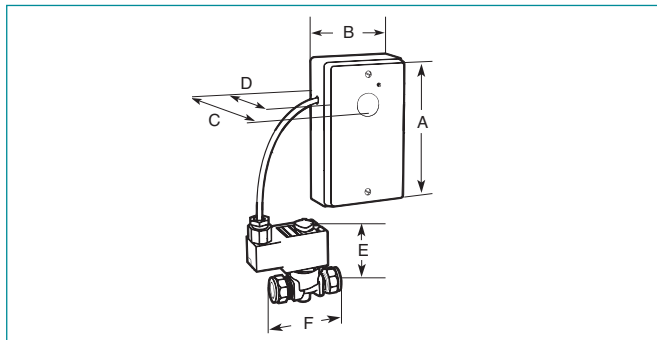

SIZES	OPTIFLUSH OP1	OPTIFLUSH OP2
A	145	145
B	85	85
C	50	50
D	40	40
E	65	65
F	69	69

TECHNICAL INFORMATION

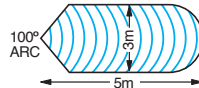
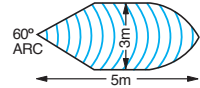
	OPTIFLUSH OP1	OPTIFLUSH OP2
PRESSURE	SUITABLE FOR ALL PRESSURES 0.05 BAR TO 12.0 BAR	SUITABLE FOR ALL PRESSURES 0.05 BAR TO 12.0 BAR
VOLTAGE	9 VOLTS DC	230 VOLTS AC 50HZ
WATTAGE	NOMINAL ¼ MW	NOMINAL ¼ MW
SUPPLY	1 X 9 VOLT PP3 (MN1604) ALKALINE BATTERY	MAINS 230 VOLTS AC FUSED 1 AMP
SOLENOID	12 VOLT 6 WATT DC LATCHING TYPE	12 VOLT 6 WATT DC LATCHING TYPE
DETECTION AREA	HORIZONTAL AREA: VIEWED FROM ABOVE 	HORIZONTAL AREA: VIEWED FROM ABOVE 

MAX. FLOW REQUIREMENTS (LITRES/HOUR)

NUMBER OF URINAL BOWLS/SLABS	1	2	3	4	5	6
MAX. FLOW REQUIREMENT	10	15	22.5	30	37.5	4

RANGE/ORDER CODES

PATTERN NO.	ORDER CODE
OPTIFLUSH OP1	599001
OPTIFLUSH OP2	599002

RECOMMENDED DAILY SETTINGS

NO. OF URINAL BOWLS/SLABS	RECOMMENDED DELAY TIME		
	A (20 MINUTES)	B (30 MINUTES)	C (40 MINUTES)
1	–	4.5 LITRE CISTERN	–
2	4.5 LITRE CISTERN	–	9 LITRE CISTERN
3	–	9 LITRE CISTERN	13.6 LITRE CISTERN
4	9 LITRE CISTERN	13.6 LITRE CISTERN	18.2 LITRE CISTERN
5	9 LITRE CISTERN	18.2 LITRE CISTERN	–
6	13.6 LITRE CISTERN	18.2 LITRE CISTERN	–

FILL TIME SETTINGS

Static Pressure (bar)	Cistern Size			
	4.5 litre	9 litre	13.6 litre	18.2 litre
0.05				
0.1				
0.2				
0.5				
1.0				
2.0				
3.0				
4.0				
5.0				
6.0				
7.0				
8.0				
9.0				
10.0				
11.0				
12.0				

Key to settings	Period	1	2	3	4
	Time	1.5 minutes	3 minutes	7 minutes	20 minutes



58XCP BIBTAP WALL FLANGE

FINISH		ORDER CODE
CHROME	15mm x 1/2"	7D3007
CHROME	22mm x 3/4"	7D3008

797MFCP 2" EXTENSION PIECE

FINISH		ORDER CODE
CHROME	1/2" M x F	322007

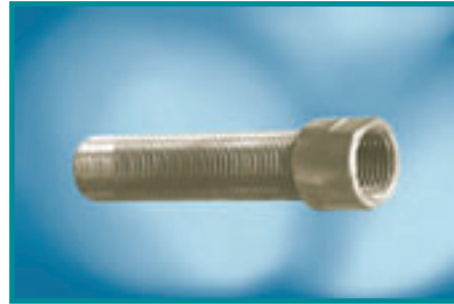

TAIL EXTENSION 50mm

FINISH	ORDER CODE
BRASS	343100

TAIL EXTENSION 175mm

FINISH	ORDER CODE
BRASS	343102